

INDICE GENERALE

descrizione tecnica per capitolato	1
suggerimenti per la posa in opera	4
pulizia e manutenzione dell'infisso	4
anodizzazione e verniciatura	5
consigli per l'assemblaggio	6
certificazioni accessori	7
certificazioni Planet 45	8
simbologia dei serramenti	10
curve limite di utilizzo	12
sagomario profili	14
profili in scala 1:1	24
vetrazione	56
elenco alfanumerico accessori e guarnizioni	59
guarnizioni	67
accessori	71
distinte di taglio	83
nodi e sezioni	90
range applicazione imbotti porte interne	123
range applicazione imbotti capannone	125
attrezzature	136
lavorazioni	143
gruppi frese	150
schede montaggio accessori	163
applicazione serrature	178

STAMPATO IN ITALIA IL 18 GENNAIO 2013

CAPITOLATO PLANET 45

Traccia per capitolato

Infissi in alluminio a camera europea realizzati con la serie Planet 45 con sistema di tenuta a giunto aperto con pinna centrale di forma tubolare. I profilati sono estrusi in lega di alluminio 6060 (EN 573.3), stato di fornitura T5 e T6 conformi alla norma EN 755.2 con tolleranze dimensionali e spessori conformi alla norma UNI12020-2 : 2001. Il telaio fisso avrà profondità 45mm mentre le parti apribili avranno una profondità di 53mm. Il sistema di tenuta sarà a giunto aperto con guarnizione centrale, in EPDM, avente un'aletta di tenuta che sormonta di 4,5 mm il piano inclinato della parte apribile, la guarnizione centrale dovrà essere raccordata nei giunti con gli opportuni angoli vulcanizzati. I profili avranno linee dritte o arrotondate internamente ed esternamente con la possibilità di accogliere soluzioni di fermavetri con taglio a 45° oppure 90°; nel caso di taglio a 90° con fermavetri arrotondati si potranno utilizzare gli appositi angoli di raccordo in alluminio pressofuso, oppure si potrà effettuare una lavorazione d'intestatura che ne consente l'applicazione senza gli angoli. La sigillatura dei vetri dovrà avvenire secondo le indicazioni riportate nel catalogo e solo ed esclusivamente con guarnizioni vetro originali. Appositi fori di drenaggio dovranno essere previsti sul telaio fisso e su quello mobile al fine di permettere il corretto drenaggio del serramento e aerazione vetro. La scelta dei profili sarà in funzione delle caratteristiche geometriche e dimensionali dell'infisso, della portata degli accessori e dei carichi di esercizio. Gli accessori utilizzati nella fabbricazione delle diverse tipologie dovranno essere solo ed esclusivamente quelli originali studiati appositamente per il sistema, riportati a catalogo e distribuiti dai licenziatari ALsistem, l'utilizzo di prodotti diversi da quelli indicati oppure il montaggio parziale o scorretto degli stessi comporterà la nullità dei certificati di prova e garanzia. La fabbricazione e la posa dovranno avvenire secondo i criteri di lavoro indicati da ALsistem. L'assemblaggio dei profili avverrà con squadrette in alluminio estruso o pressofuso multifunzione, i tagli dovranno essere protetti a mezzo sigillanti neutri.

La protezione e finitura dei profilati avverrà a mezzo dei normali trattamenti di superficie, ossidazione anodica conforme al marchio di qualità "Qualanod" oppure a mezzo di verniciatura con polveri poliesteri termoindurenti e polimerizzate in forno a temperature comprese tra 185°C e 195°C, in conformità del marchio di qualità "Qualicoat".

Materiali

L'esecuzione dei serramenti è in lega d'alluminio EN AW 6060 sotto forma di profilati estrusi come indicato dalla disposizione normativa EN 755.3. Lo stato di fornitura è in classe T5 e T6 secondo norma EN 755.2. Le tolleranze dimensionali sono conformi alla UNI 12020-2 : 2001.

Caratteristiche tecniche e dimensionali

Aspetto visivo esterno: complanare

Aspetto visivo interno: complanare o sormonto di 8mm

Profilati: estrusi in lega leggera 6060 (UNI35690TA) anodizzabili e verniciabili

Sistema di tenuta: giunto aperto di 4,5 mm con precamera o doppia battuta, con guarnizioni in EPDM

Sistema di accessori: a camera europea di ottima qualità

Distanza telaio anta: 11.5 mm

Sovrapposizione battuta anta su telaio: 6 mm

Altezza battuta vetro: 22 mm

Fuga tra i profili: 5 mm

Profondità telaio: 45 mm

Profondità anta: 53 mm

Tubolarità profili finestra: 15 mm

Tubolarità profili porta: 36.4 mm

Fissaggio vetri: con fermavetri lisci, raggiati, smussati, modanati o vetroinfilare

Spazio vetro o pannello nei telai fissi: da 9,5 mm a 38 mm

Spazio vetro o pannello nelle ante: da 10 mm a 45,5 mm

Protezione superficiale

La protezione dei profilati potrà essere effettuata mediante ossidazione anodica con classe di spessore >15 micron, come da norma UNI4522/00 (66-70), oppure mediante verniciatura a polveri poliesteri termoindurenti e polimerizzate in forno nel rispetto delle procedure di qualità "Qualicoat" e delle disposizioni UNI EN 12206-1.

Resistenza della finitura

La finitura superficiale non deve subire corrosioni o alterazioni di aspetto per un periodo di tempo adeguato alla vita del manufatto. Le caratteristiche sufficienti per assicurarne il comportamento in funzione del tipo di ambiente sono specificate dalle norme UNI4522/00 per l'ossidazione e UNI EN 12206-1 per la verniciatura, ricordando che i principali fattori che influiscono sulla resistenza all'ambiente sono la vicinanza al mare, l'inquinamento atmosferico, la manutenzione e la pulizia anche dalla pioggia.

Sicurezza

Al fine di non causare danni fisici o lesioni agli utenti, i serramenti devono essere concepiti secondo le prescrizioni della normativa in materia di sicurezza D.Lgs. 81/2008 e UNI 7697-07.

Caratteristiche della vetrazione

La scelta della vetrazione deve essere effettuata secondo criteri prestazionali per rispondere ai requisiti di risparmio energetico, isolamento acustico, controllo della radiazione solare, sicurezza. Riferimento norme: UNI EN ISO 140-3:06, UNI6534:74, UNI EN 572-1:04, UNI EN 12758:04, UNI EN 12150-1:01, UNI 7143:72 DM 2 Aprile 1998.

Guarnizioni

Le guarnizioni dovranno essere esclusivamente quelle originali studiate per il sistema, a garanzia delle prestazioni dello stesso e rispondenti alle norme di riferimento UNI 3952:98, UNI 12365:05.

Sigillanti

I sigillanti devono corrispondere a quanto prescritto dalle norme di riferimento UNI EN ISO 11600:04. Tali materiali non devono corrodere le parti in alluminio e sue leghe con cui vengono a contatto, pertanto dovranno essere neutri.

Accessori

Gli accessori dovranno essere quelli originali prodotti per la serie e rispondenti ai criteri indicati nelle norme UNI e alle disposizioni normative in materia di sicurezza D.Lgs. 81/2008.

Prestazioni

La serie Planet 45 risponde ai requisiti della norma UNI EN 12207:00, UNI EN 12208:00, UNI EN 12210:00.

Resistenza meccanica

Il sistema e gli accessori saranno resistenti alle sollecitazioni d'uso secondo i limiti stabiliti dalle norme UNI 12365:05.

Isolamento acustico

La scelta della classe di isolamento acustico di un serramento va correlata alla destinazione d'uso del locale nel quale l'infisso dovrà essere inserito ed al livello del rumore esterno; il comportamento del serramento in opera è influenzato da fattori che non è possibile definire a priori (h dal suolo, orientamento delle sorgenti sonore, ecc...). Il potere fonoisolante potrà essere quindi stimato con buona approssimazione, in base alla permeabilità all'aria del serramento con un minimo di valore di permeabilità pari a 2, ed al potere fonoisolante del vetro. Secondo la metodologia descritta nella norma di riferimento UNI EN ISO 140-3:06.

Isolamento termico

La scelta delle prestazioni di isolamento termico deve essere operata in base alle esigenze di risparmio energetico secondo la legge 10/91 e DL.192/05 e aggiornamento DL.311/06 ed alle esigenze di benessere ambientale o riferimento alla norma UNI EN ISO 10077-1:07. Si può calcolare la trasmittanza termica del serramento a partire dai valori di trasmittanza dei profili e delle superfici secondo norma UNI EN ISO 10077-1:07 con la formula:

$$U_w = (A_g \cdot U_g + A_f \cdot U_f + I_g \cdot \psi) \div (A_g + A_f)$$

Certificazioni

Sarà possibile richiedere al costruttore dei serramenti o, in mancanza, al licenziatario di zona, fotocopia dei rapporti di prova relative a determinate prestazioni.

Marcatura CE UNI EN 14351-1

La marcatura CE è **OBBLIGATORIA** e costituisce il sistema al quale tutti i Costruttori di serramenti devono uniformarsi per poter vendere i propri prodotti nell'Unione Europea. Spetta al Costruttore, o al suo rappresentante, con sede nella EEA [Area Economica Europea] la responsabilità di apporre la marcatura CE sul prodotto, su un'etichetta applicata al prodotto, sul suo imballaggio o sui documenti commerciali di accompagnamento.

La norma UNI EN 14351-1 si applica alle finestre, porte finestre, alle porte pedonali esterne, alle porte esterne sulle vie di fuga, alle finestre da tetto/lucernari (incluse quelle resistenti al fuoco proveniente dall'esterno), alle finestre a nastro, alle finestre accoppiate e alle finestre doppie. Tali serramenti possono essere a una o più ante, con ante mobili e parti fisse, con apertura verso l'interno o verso l'esterno, a movimentazione manuale oppure automatizzata, interamente oppure parzialmente vetrati, con o senza telaio di contenimento della vetratura, con o senza dispositivi di schermatura incorporati.

La norma UNI EN 14351-1 non è applicabile a:

- finestre, portefinestre e porte pedonali con caratteristiche di resistenza al fuoco e tenuta al fumo
- alle porte interne (EN 14351-2)
- alle chiusure oscuranti esterne (UNI EN 13659)
- alle porte girevoli
- alle finestre poste sulle vie di fuga

La norma contempla determinati requisiti volontari e/o obbligatori:

- Tenuta all'acqua
- Rilascio di sostanze pericolose
- Resistenza all'urto
- Resistenza al vento
- Capacità portante dei dispositivi di sicurezza
- Isolamento acustico
- Isolamento termico
- Proprietà radianti delle vetrazioni (trasmissione Luminosa)
- Permeabilità all'aria

Piano di Controllo di Produzione (FPC)

Il controllo di produzione in fabbrica è un sistema esercitato dal costruttore sotto propria responsabilità, al fine di assicurare che le caratteristiche costruttive del prodotto siano mantenute nel tempo entro certi limiti. Il costruttore dovrà stabilire delle procedure documentate, che indichino le modalità che, il personale addetto ai vari controlli, dovrà effettuare per monitorare con frequenza ed esattezza il processo assegnatogli. Il costruttore è tenuto a garantire la rintracciabilità del prodotto attraverso l'uso di codici o altro. Mediante uno schema, il produttore è inoltre tenuto a comunicare al committente indicazioni circa l'utilizzo, la movimentazione, l'installazione, la manutenzione e pulizia del prodotto. Non sono invece analizzate le caratteristiche dell'installazione.

Test di Laboratorio (ITT)

Le caratteristiche del serramento sono valutate sul prodotto finito completo di ferramenta, vetrocamera, pannelli e di tutti gli accessori e trattamenti che lo rendono pronto all'uso. Il costruttore che lo richieda può ottenere i risultati delle prove (ITT) sui serramenti direttamente dall'ALsistem oppure dal licenziatario di zona, la quale cede il diritto d'uso dei risultati degli attestati dei propri ITT ricevuti dal Laboratorio, tramite un contratto fra le parti a "Cascading" (Cascata). Il costruttore ha la responsabilità della conformità del prodotto alle norme europee indicate sul progetto di norma e recepite dalle norme nazionali (norme UNI).

Posa in opera

E' molto importante, per ottenere un buon funzionamento del serramento, curare scrupolosamente la verticalità e il livellamento dell'infisso, dopodiché eseguire la sigillatura usando mastici neutri seguendo i consigli dell'esempio sotto riportato, Controllare inoltre che le aperture siano caricate sufficientemente (spessorando il vetro di 1-2 mm fuorisquadro), affinché, con l'assestamento dei materiali, non si verifichino mal funzionamenti nel tempo.

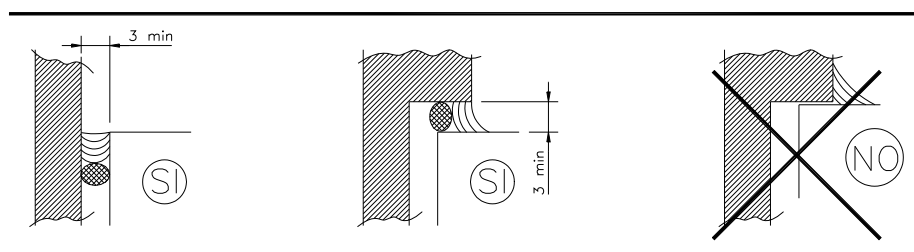

Manutenzione delle superfici in alluminio

A seguito dei forti tassi di inquinamento oramai raggiunti in tutti i paesi, specialmente nei grossi centri urbani e nelle zone costiere battute dal vento marino, è molto importante che le superfici in alluminio, a contatto con l'atmosfera, siano periodicamente pulite.

Il nostro intento è quello di sensibilizzare il costruttore dei serramenti affinché possa di riflesso consigliare IL CLIENTE nel migliore dei modi.

E' buona norma tenere in considerazione 3 punti fondamentali:

1. quante volte deve essere eseguita l'operazione di pulizia nell'arco dell'anno
2. il periodo
3. il prodotto da usare

Ecco le risposte:

Il numero di interventi viene stabilito sulla base dello stato di inquinamento della zona in cui è ubicato l'edificio, varia da 1 a 3 volte l'anno.

Il periodo può essere:

- a fine inverno
- a metà estate
- a metà autunno da scegliere a seconda del numero di interventi

Il prodotto per la pulizia è importante che sia neutro, un prodotto sbagliato potrebbe rovinare i materiali di diversa natura di cui è composto un serramento, come guarnizioni, sigillanti, marmi, ecc..... e causare danni che potrebbero compromettere la funzionalità e la durata nel tempo dello stesso.

Le caratteristiche di tali prodotti assieme alla frequenza di pulizia da adottare sono definite nei progetti di norma UNIMET12.04.270 ed E12.04.277.0.

In mancanza di un prodotto neutro è preferibile utilizzare acqua tiepida con un panno non abrasivo.

Per una corretta installazione, manutenzione e pulizia dei serramenti, vi invitiamo inoltre a consultare le prescrizioni riportate sulle seguenti note tecniche Uncsaal:

UX 42 guida alla posa in opera delle finestre

UX 10 pulizia delle superfici di serramenti e facciate continue.

Fasi di verniciatura

1. Il ciclo di verniciatura offre la possibilità di ottenere sugli infissi un eccellente rivestimento protettivo superficiale ed una maggiore vivacità del colore;
2. lo strato deve avere uno spessore min. di 60 micron sulle parti a vista;
3. il materiale sarà sottoposto al seguente processo:
 - sgrassatura senza attacco
 - lavaggio
 - decapaggio alcalino con attacco, oppure acido
 - lavaggio
 - disossidazione
 - lavaggio
 - conversione protettiva
 - lavaggio in acqua demineralizzata
 - asciugatura a 75°C
 - verniciatura in polveri termoindurenti
 - polimerizzazione in forno

Tutte le lavorazioni eseguite su alluminio devono essere conformi a quanto previsto dal marchio di qualità Qualicoat®.

Fasi di anodizzazione

1. Lo strato ossido può variare secondo la zona di ubicazione del serramento da 15 a 20 micron (UNI4522-66);
2. può essere normale o elettrocolore;
3. il materiale sarà sottoposto al seguente processo:
 - sgrassatura senza attacco
 - lavaggio
 - decapaggio alcalino con attacco (tranne le finiture lucide)
 - lavaggio
 - disossidazione
 - lavaggio
 - ossidazione in bagno acido solforico a 18/20°C, densità della corrosione 1,5[A]dmq
 - colorazioni inorganiche od organiche od elettrocolore (tranne argento)
 - lavaggio doppio
 - asciugatura
 - fase di fissaggio a caldo in ebollizione a sali di nichel, fissaggio 2,5/3 minuti per ogni micron di spessore

Osservazione

Nella fase preventiva il progettista o il serramentista dovrà determinare il tipo di serramento da impiegare sulla base degli elementi forniti dal committente. Nella scelta o controllo si dovrà considerare, sulla base della pressione del vento, il momento d'inerzia necessario e scegliere il profilato occorrente nella gamma Planet. Ovviamente dovranno essere utilizzati adeguati accessori, tra quelli originali ALsistem, predisposti per le serie Planet.

Dimensione profilati

Le dimensioni e i pesi indicati sui disegni dei profilati a catalogo sono quelli teorici e possono variare in funzione delle tolleranze dimensionali di estrusione (Norme UNI EN 12020-02) e dal tipo di finitura. Anche la verniciatura, contribuisce ad aumentare gli spessori riducendo pertanto le sedi di inserimento delle guarnizioni e degli accessori. Questa variabilità potrebbe condizionare le dimensioni del taglio e di conseguenza quelle del serramento finito. Le differenze di taglio potranno aumentare in modo proporzionale anche in base al numero di ante per serramento. Si consiglia, nei primi lavori o in quelli con quantità importanti, di realizzare un campione reale per verificarne il corretto funzionamento.

Dimensioni taglio

Le dimensioni teoriche di taglio indicate nel presente catalogo si dovranno modificare in funzione della tipologia e sulla base della precisione della macchina di taglio che si sta utilizzando, (ad es. per porte a 2 ante ap.est. con maniglione antipanico, la fuga dovrà essere 8mm anziché 5mm; le finestre a 3 e 4 ante e le finestre di misure ridotte dovranno avere le ante più strette del teorico per evitare interferenze sulla rotazione, ecc...).

Consigli per un corretto assemblaggio

Per ottenere i migliori risultati utilizzando i profili Planet si consiglia di osservare attentamente tutte le voci di seguito riportate, atte a rinforzare tutti i punti deboli di una finestra comune, ottimizzando così le prestazioni offerte dal serramento.

Procedura corretta	Obiettivo
sigillare i profili tra loro nel giunto a 45°	evita infiltrazioni d'acqua evita la corrosione e l'ossidazione
sigillare i profili sul montante quando gli stessi vengono intestati	evita infiltrazioni d'acqua evita la corrosione e l'ossidazione
utilizzare la guarnizione giunto aperto sulla soglia anche nella soluzione doppia battuta	facilita l'evacuazione dell'acqua
utilizzare l'angolo vulcanizzato della guarnizione di battuta centrale	aumenta la permeabilità all'aria aumenta la tenuta all'acqua
usare curve limite di utilizzo per la scelta del profilo	evita scelte inadeguate del profilo
sigillare il serramento sul perimetro tra profilo e controtelaio con sigillante neutro	evita infiltrazioni d'acqua
utilizzare sempre il tassello di registro	facilita la posa in opera inquadra meglio il telaio isola i materiali limita la trasmissione delle vibrazioni
proteggere tutte le lavorazioni effettuate sui profilati	evita la corrosione e l'ossidazione facendo aumentare la durata dell'infisso nel tempo
per infissi con aperture antipanico usare profili maggiorati	facilita l'applicazione degli accessori
utilizzare controsagome durante il taglio a 45°	garantisce un taglio corretto al fine di ottenere una giunzione d'angolo perfetta
utilizzare squadrette multifunzione	garantisce giunzioni di alta qualità e sigillature ad iniezione

Certificazione accessori

I prodotti in alluminio verniciato sono certificati secondo le specifiche tecniche del:

QUALICOAT



I prodotti in alluminio anodizzato sono certificati secondo le specifiche tecniche del:

EURAS
EWAA
QUALANOD



Gli accessori per le gamme Planet sono prodotti da aziende certificate ISO9001 e ISO14001

Importante

Tutti i dati esposti in questo catalogo sono puramente indicativi e non impegnano in nessun modo la società la quale si riserva la possibilità di portare migliorie ai suoi prodotti in qualunque momento lo ritenga necessario. La società si riserva il diritto di proprietà del presente catalogo con la proibizione di riprodurlo o trasferirlo a terzi senza l'autorizzazione scritta.

Certificazioni serie Planet 45

Il sistema Planet 45 è stato sottoposto alle prove indicate in tabella per le diverse tipologie di serramenti.

TIPOLOGIE SERRAMENTI	PROVE				
	Misure del serramento	Numero certificato	Valore prova permeabilità all'aria	Valore prova tenuta all'acqua	Valore prova resistenza al vento
Finestra 2 ante ribalta	H =1.239 mm L =1.439 mm	0443/2006	classe 4	classe E1200	classe C5
Portafinestra a 2 ante ribalta	H =2.400 mm L =1.500 mm	1994-CPD-RP0612	classe 4	classe E1050	classe C4

Richiedere contratto Cascading al licenziatario di zona per ottenere i rapporti di prova ITT in versione integrale.

IRcCOS S.c.a.r.l.

Istituto di Ricerca e certificazione per le Costruzioni Sostenibili



Laboratorio di Prova Notificato ai sensi della Direttiva 89/106/CEE n. N81594

RAPPORTO DI PROVA

Numero:

1994-CPD-RP0612

Data del rilascio:

2011-03-31

Richiedente:

**Al Sistem S.c.a.r.l.
Via Reiss Romoli, 267
10148 Torino**

Denominazione Campione/Prodotto sottoposto a prova:

**Porta finestra a due ante a battente di cui una oscillobattente in
alluminio,
commercialmente denominata "PLANET 45"
(cfr. descrizione)**

Prove eseguite:

**Permeabilità all'aria
Tenuta all'acqua
Resistenza al carico del vento**

Riferimenti normativi:

**EN 14351-1:2006+A1:2010
EN 1026:2000 EN 12207:1999
EN1027:2000 EN12208:1999
EN 12211:2000 EN 12210:1999***Questo Rapporto è composto da 17 pagine, compresi gli eventuali allegati, e può essere riprodotto solo integralmente.*Sede legale Via Cremona 1 - 20025 Legnano (MI) - Tel. 0331 594628 - Fax 0331 458211 - www.irccos.com
Cap. Soc. € 490.000 LV. - C.F. e P. Iva 05159630960 - Reg. Imprese Milano 05159630960 - R.E.A. 1799766

7.6 Prova di sicurezza

	Danni o degradi funzionali rilevati
n° 1 colpo a + 2400 Pa	nessuno
n° 1 colpo a - 2400 Pa	nessuno

Tab. 21

7.6.1.1 Osservazioni sui risultati ottenuti

Al termine della prova di sicurezza non è stato riscontrato alcun distacco o degrado funzionale nel campione ed il campione è rimasto chiuso.

7.6.2 Classificazione del campione

Il campione sottoposto a prova di resistenza al carico del vento è stato classificato in classe **C4**.

7.7 Schema riepilogativo

Prova:	Permeabilità all'aria	Tenuta all'acqua	Resistenza ai carichi del vento
Classe ottenuta:	4	E 1050	C4

Tab. 22: Schema riepilogativo dei risultati ottenuti

8. Fotografie del campione sottoposto a prova e dell'assetto sperimentale



Foto 1: Campione sottoposto a prova nell'assetto sperimentale

Il presente Rapporto di Prova è conforme alla norma UNI CEI EN ISO/IEC 17025

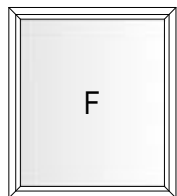
Tipologie costruttive e indicazioni dimensionali (vista interna)

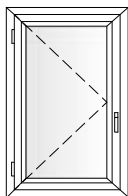

fisso



1 anta

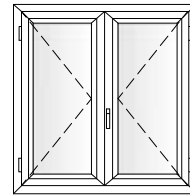

2 ante

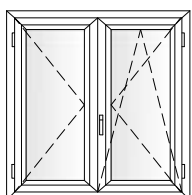

anta ribalta

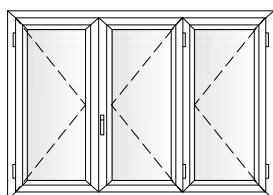

3 ante

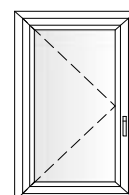

apertura esterna

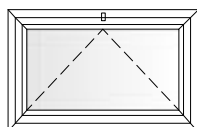

vasistas

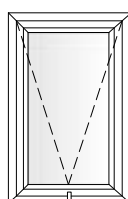

sporgere

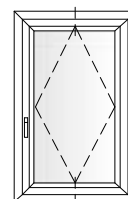

bilico verticale

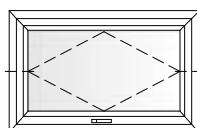

bilico orizzontale

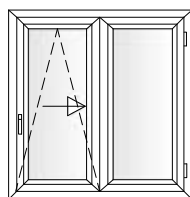

scorrevole parallelo

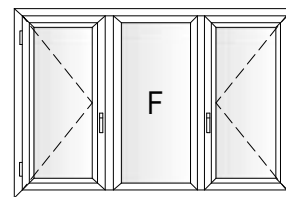

finestratura a nastro

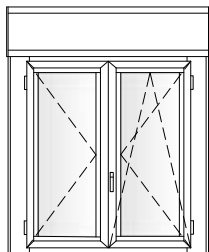

monoblocco

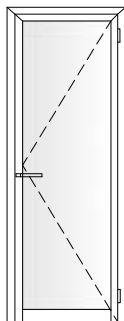

porte interne

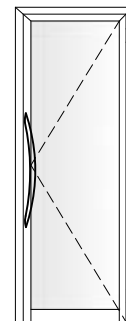

portoncino apertura
interna 1 anta

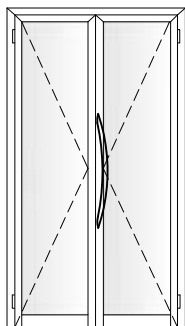

portoncino apertura
interna 2 ante

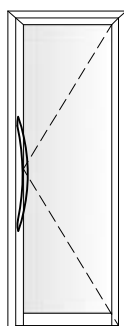

portoncino apertura
esterna 1 anta

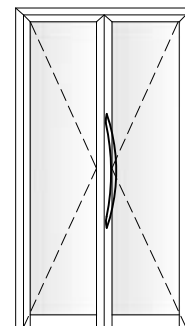

portoncino apertura
esterna 2 ante

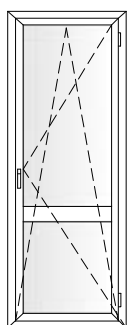

porta finestra 1 anta
ribalta

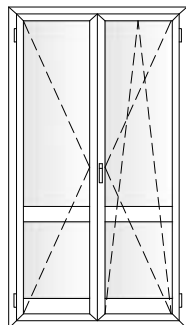

porta finestra 2 ante
ribalta

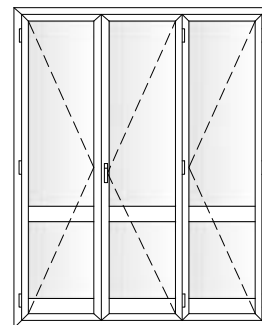

porta finestra 3 ante

si consiglia di non realizzare finestre con ante di larghezza inferiore a L=350 mm

curve limite di utilizzo

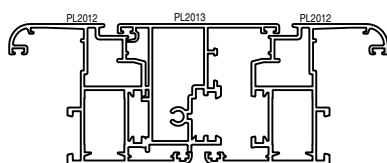
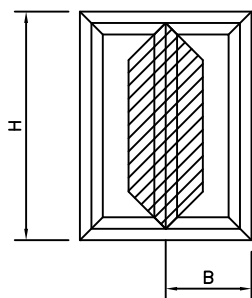

$J_t = 39.14 \text{ cm}^4$

freccia max 1/300

VERIFICARE CHE LA FRECCIA DEL PROFILO
SIA COMPATIBILE COL VETRO IMPIEGATO

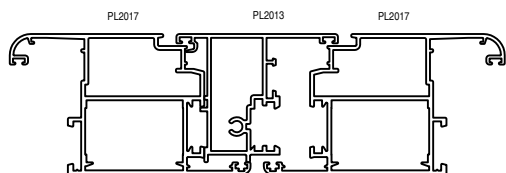
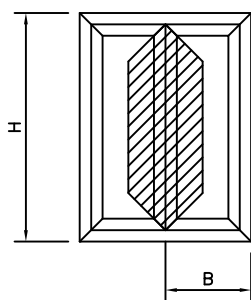
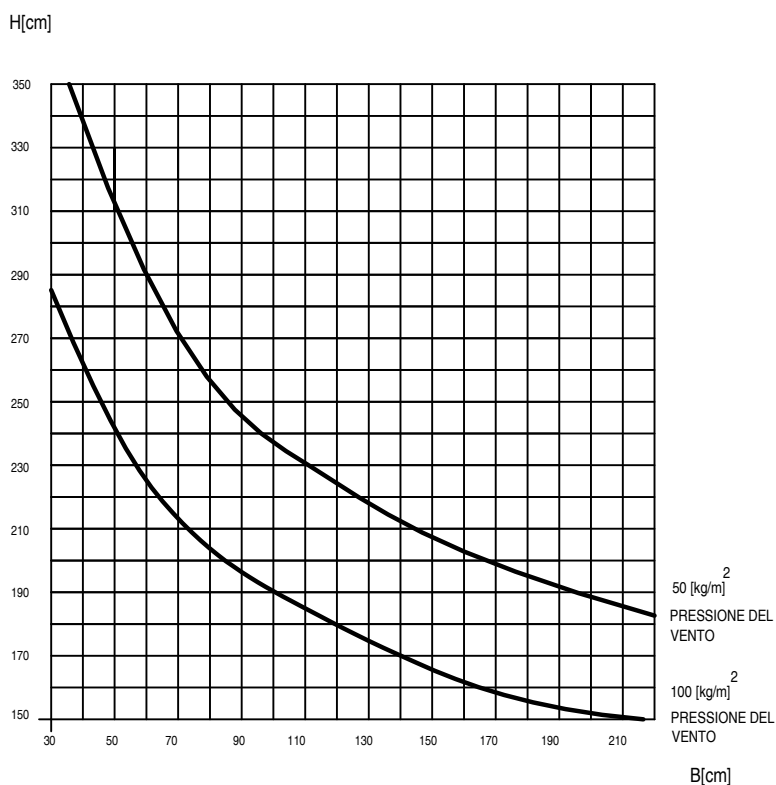

$J_t = 48.73 \text{ cm}^4$

freccia max 1/300

VERIFICARE CHE LA FRECCIA DEL PROFILO
SIA COMPATIBILE COL VETRO IMPIEGATO

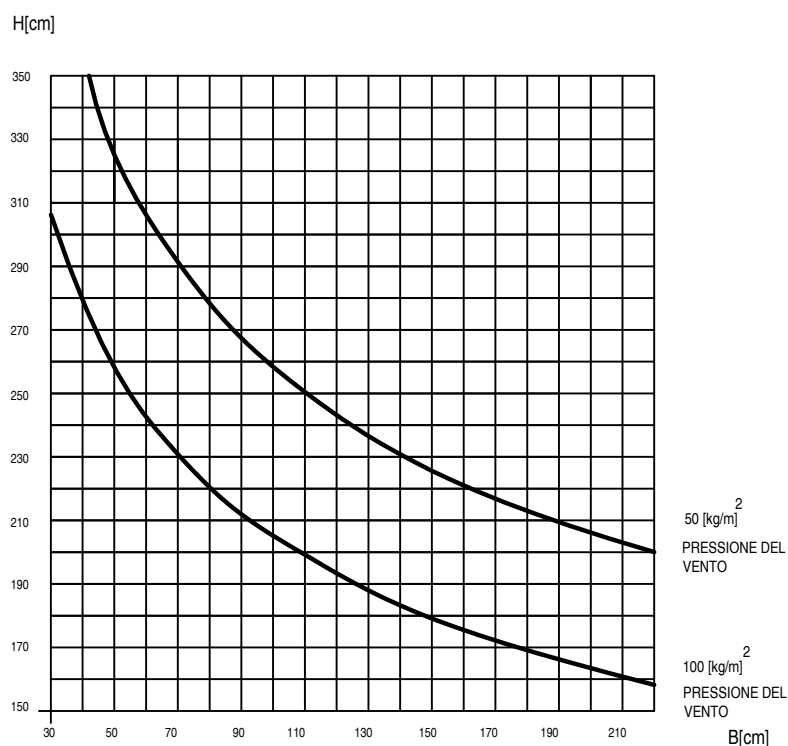

curve limite di utilizzo

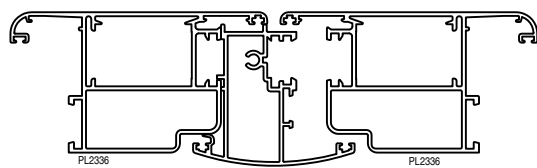
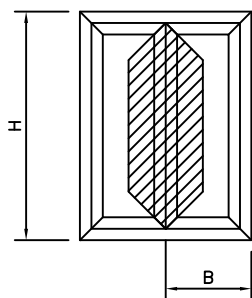

$J_t = 54.74 \text{ cm}^4$

freccia max 1/300

VERIFICARE CHE LA FRECCIA DEL PROFILO
SIA COMPATIBILE COL VETRO IMPIEGATO

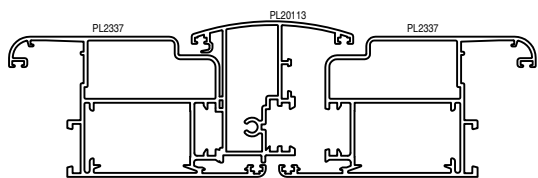
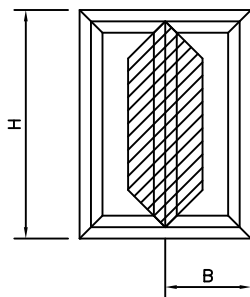
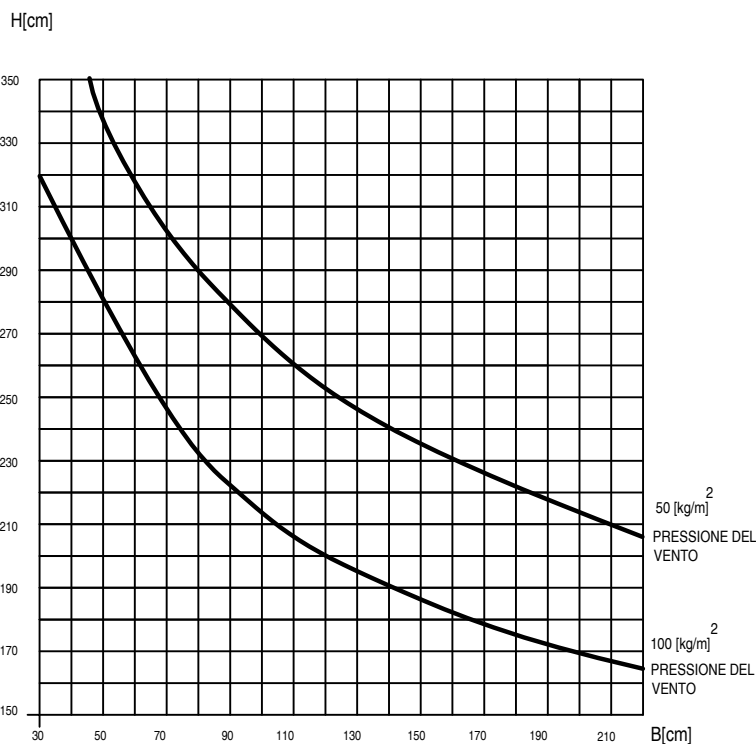







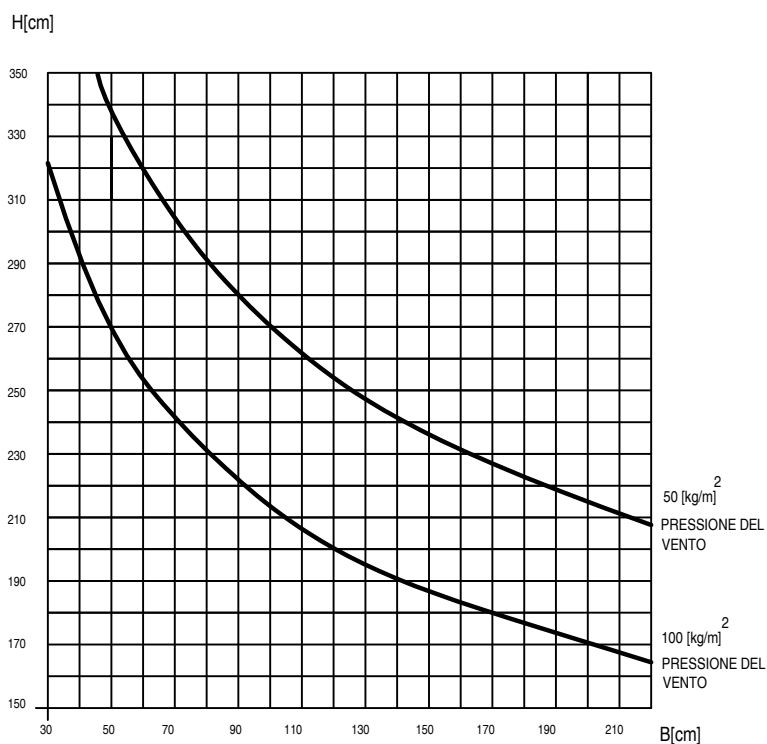

















$J_t = 55.61 \text{ cm}^4$

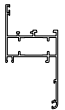
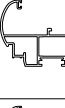

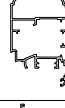
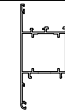

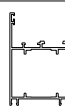

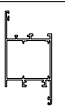
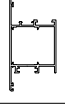
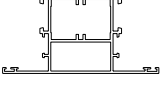

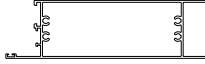
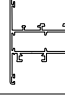
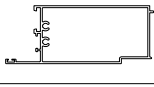
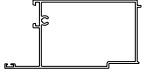





freccia max 1/300

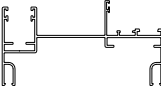
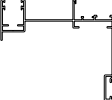

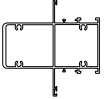
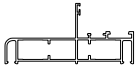

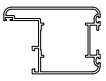







VERIFICARE CHE LA FRECCIA DEL PROFILO
SIA COMPATIBILE COL VETRO IMPIEGATO

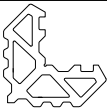

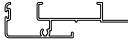



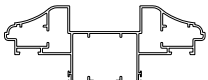

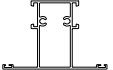
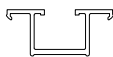









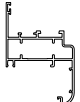



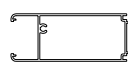

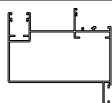





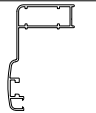
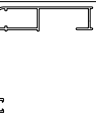

ART.	SAGOMA	DESCRIZIONE	PESO gr/m	Jxx cm ⁴ Jyy cm ⁴
PL 2001		TELAIO FISSO a T BATTUTA 22 mm MURO 40 mm	897	9.97 7.58
PL 2002		TELAIO FISSO a Z BATTUTA 22 mm MURO 40 mm	886	9.97 7.58
PL 2003		TELAIO FISSO a L	774	7.87 4.17
PL 2004		TELAIO FISSO a L LISCIO	731	7.18 3.62
PL 2006		SOGLIA H=36mm	537	5.20 1.41
PL 2007		TELAIO FISSO a L MAGGIORATO LISCIO	904	10.27 12.28
PL 2008		TELAIO FISSO a Z MODANATO COMPLANARE INTERNO BATTUTA 25 mm MURO 47 mm	1064	17.30 10.68
PL 2009		TELAIO FISSO a L MODANATO COMPLANARE INTERNO DA ABBINARE A PL 2008	933	13.52 5.49
PL 2011		ANTA LISCIA	1044	13.99 7.76
PL 2012		ANTA RAGGIATA	1060	14.25 5.95
PL 2013		RIPORTO CENTRALE LISCIO	918	9.71 6.06
PL 2014		INVERSIONE BILICO	959	9.37 7.15
PL 2016		ANTA LISCIA MAGGIORATA	1365	18.78 23.12
PL 2017		ANTA RAGGIATA MAGGIORATA	1321	19.03 25.71
PL 2018		ANTA VETRO INFILARE MAGGIORATA	1350	19.14 27.15
PL 2019		ANTA BILICO	1233	18.28 29.63











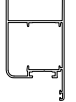



ART.	SAGOMA	DESCRIZIONE	PESO gr/m	Jxx cm ⁴ Jyy cm ⁴
PL 2022		TELAIO FISSO a Z BATTUTA 40 mm MURO 40 mm	1011	11.02 13.69
PL 2025		ANTA BOMBATA DA 58 mm	1087	15.85 9.39
PL 2026		ANTA BOMBATA MAGGIORATA	1451	22.42 29.68
PL 2028		ANTA VETRO INFILARE MODANATA MAGGIORATA SPAZIO VETRO 25mm	1485	24.25 29.92
PL 2031		TELAIO FISSO a T MAGGIORATO BATTUTA 30mm MURO 40 mm	1171	13.25 25.96
PL 2032		TELAIO FISSO a Z MAGGIORATO BATTUTA 22 mm MURO 40 mm	1137	12.98 21.23
PL 2033		TELAIO FISSO a L MAGGIORATO	951	10.92 14.34
PL 2034		ANTA VETRO INFILARE BOMBATA MAGGIORATA SPAZIO VETRO 25 mm	1477	24.56 30.15
PL 2035		TELAIO FISSO a Z MAGGIORATO DOPPIA BATTUTA BATTUTA 17,5 mm MURO 41,5 mm / ANTA MAGGIORATA	1176	13.24 21.02
PL 2036		TELAIO FISSO a T MAGGIORATO DOPPIA BATTUTA APERTURA ESTERNA - BATTUTA 17,5 mm MURO 41,5 mm /ANTA MAGGIORATA	1146	12.53 21.02
PL 2038		TRAVERSO DA 92mm PER FISSI ED ANTE RAGGIAE FISSAGGIO CON CAVALLOTTO	1222	12.39 19.87
PL 2040		FASCIA DA 165mm SEZ. 45 mm	1833	23.12 15.96
PL 2041		ZOCCOLO DA 158mm SEZ. 45 mm	1862	23.66 15.46
PL 2042		ANTA A T APERTURA ESTERNA SORMONTO / TELAIIO FISSO A T BATTUTA 17,5 mm MURO 41,5 mm	954	9.41 7.30
PL 2047		ZOCCOLO RIPORTATO SEZ. 45 mm	1369	16.45 59.34
PL 2048		ZOCCOLO RIPORTATO PER ANTE PL2011 E PL2016 SEZ. 53 mm	1267	21.90 47.91





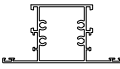





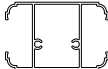





ART.	SAGOMA	DESCRIZIONE	PESO gr/m	Jxx cm ⁴ Jyy cm ⁴
PL 2050		TELAIO FISSO a Z / ANTA DOPPIA BATTUTA BATTUTA 17,5 mm MURO 41,5 mm	956	9.79 7.08
PL 2051		ANTA VETRO INFILARE SPAZIO VETRO 25mm	1122	14.44 9.70
PL 2052		FASCIA VETRO INFILARE 140mm SPAZIO VETRO 25mm SEZ. 37 mm	1530	14.13 10.89
PL 2053		TRAVERSO VETRO INFILARE 59mm SPAZIO VETRO 25mm SEZ. 37 mm	846	6.84 7.82
PL 2056		ANTA PER SPORGERE	1123	13.75 11.41
PL 2060		GUIDA TAPPARELLA APPLICATA	947	- -
PL 2061		MEZZA SPALLA MONOBLOCCO CON SPAZIO ZANZARIERE	1819	137.73 14.68
PL 2063		SPALLA APERTA MONOBLOCCO CON SPAZIO ZANZARIERE	1993	147.14 57.32
PL 2066		SUPPORTO CASSONETTO MONOBL. INFERIORE E SUPERIORE	199	- -
PL 2068		PILASTRO PER FINESTRATURE	2077	74.43 35.66
PL 2069		MEZZO PILASTRO PER FINESTRATURE	1339	46.54 5.18
PL 2070		COPRICAVA PER PL2071 E PL2073	214	- -
PL 2071		ANTA PORTE AUTOMATICHE ED A VENTOLA	1236	17.70 25.81
PL 2072		PROFILO DI RIEMPIMENTO PER PORTE AUTOMATICHE	331	- -
PL 2073		PORTA SPAZZOLINO ABBINABILE CON PL 2070	231	- -
PL 2075		PROFILO GIUNZIONE FINESTRATURE	527	- -

















ART.	SAGOMA	DESCRIZIONE	PESO gr/m	Jxx cm ⁴ Jyy cm ⁴
PL 2076		TELAIO COMPENSATORE PER FINESTRATURE	776	8.57 4.21
PL 2077		CONTROTELAIO FINESTRATURE	385	- -
PL 2080		PROFILO CORNICE	1190	- -
PL 2081		PROFILO COMPENSATORE MURO/TELAIO	404	- -
PL 2084		PROFILO PER SQUADRETTE CIANFRINARE	6461	- -
PL 2087		ANTA LISCIA PORTE INTERNE PANNELLO DA 40 mm	872	9.09 5.84
PL 2088		TRAVERSO TELAIO MONOBLOCCO	759	7.58 4.38
PL 2089		CELINO MONOBLOCCO	827	- -
PL 2090		PROFILO PER SQUADRETTE CIANFRINARE	2720	- -
PL 2091		GUIDA SOTTOZOCOLO PORTE AUTOMATICHE SCORREVOLI	304	- -
PL 2092		TELAIO ANGOLO VARIABILE	763	- -
PL 2093		TELAIO ANGOLO VARIABILE	720	- -
PL 2094		PROFILO SCOPELLO DOPPIA BATTUTA	2315	167.14 24.78
PL2095		PROFILO DI ABBINAMENTO SLIDE 60	1208	12.88 11.18
PL2096		TRAVERSO H = 81 PER ANTE PL2011 E PL 2016 SEZ. 53 mm	1029	16.18 12.38
PL2097		RIDUTTORE VETRO 12 mm PER ANTE PORTE INTERNE	379	- -















ART.	SAGOMA	DESCRIZIONE	PESO gr/m	Jxx cm ⁴ Jyy cm ⁴
PL2098		RIDUTTORE VETRO 24 mm PER ANTE PORTE INTERNE	398	- -
PL 2099		SOGLIA CALPESTABILE	511	- -
PL 20100		GOCCIOLATOIO	129	- -
PL 20101		TELAIO FISSO a T COMPLANARE INTERNO BATTUTA 22 mm MURO 53 mm	951	11.81 7.59
PL 20102		TELAIO FISSO a Z COMPLANARE INTERNO BATTUTA 22 mm MURO 40 mm	1000	13.77 9.28
PL 20103		TELAIO FISSO a L COMPLANARE INTERNO	885	10.37 4.45
PL 20113		RIPORTO CENTRALE RAGGIATO	984	11.81 6.94
PL 20120		INVERSIONE DI BATTUTA	745	6.70 3.94
PL 20121		TELAIO FISSO A Z COMPLANARE INTERNO BATTUTA 30 mm MURO 40 mm	1053	14.81 12.70
PL 20126		RINFORZO SOGLIA RIBASSATA	260	- -
PL 20127		SOGLIA RIBASSATA H=25mm	500	- -
PL 20138		TRAVERSO DA 72mm PER FISSI E ANTE RAGGIATE FISSAGGIO CON CAVALLOTTO	911	9.06 7.61
PL 20148		ZOCCOLO RIPORTATO DA 90mm VETRO AD INFILARE	1103	9.58 35.98
PL 20152		FASCIA H 100 mm PORTE INTERNE	1308	16.37 40.99
PL 20163		SPALLA CHIUSA MONOBLOCCO CON SPAZIO ZANZARIERE	2785	19.60 93.31
PL 20187		ANTA RAGGIATA PORTE INTERNE	947	12.39 6.47

ART.	SAGOMA	DESCRIZIONE	PESO gr/m	Jxx cm ⁴ Jyy cm ⁴
PL 20190		TELAIO FISSO PORTE INTERNE	1359	33.32 25.60
PL 20192		IMBOTTE AGGIUNTIVO PER TELAI A L MAGGIORATI	636	- -
PL 20193		IMBOTTE DA 45mm	946	- -
PL 20194		IMBOTTE DA 75mm	1149	- -
PL 20195		IMBOTTE DA 105mm	1306	- -
PL 20196		PROLUNGA IMBOTTI DA 90mm	686	- -
PL 20198		IMBOTTE DA 135mm	1504	- -
PL 20226		PROFILO COPRICAVA PER PL20163, PL2063, PL20325, PL2077, PL2071	95	- -
PL 20228		BATTUTA RIPORTATA 22mm PER TELAI FISSI	225	- -
PL 20248		ZOCCOLO RIPORTATO DA 59 mm VETRO INFILARE SEZIONE 37 mm	847	6.83 11.42
PL 20287		ANTA RAGGIATA MAGGIORATA PORTE INTERNE PANNELLO DA 40 mm	1215	17.64 22.18
PL 20293		IMBOTTE DA 48.5mm	832	- -
PL 20294		IMBOTTE DA 78.5mm	1022	- -
PL 20295		IMBOTTE DA 108.5mm	1236	- -
PL 20296		PROLUNGA IMBOTTI DA 103mm	816	- -
PL 20298		IMBOTTE DA 138.5mm	1472	- -

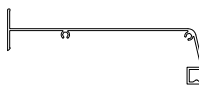
ART.	SAGOMA	DESCRIZIONE	PESO gr/m	Jxx cm ⁴ Jyy cm ⁴
PL 20325		TELAIO CAPANNONI	2337	123.09 75.94
PL 20387		ANTA PORTE INTERNE MAGGIORATA DRITTA PANNELLO DA 40 mm	1035	12.27 17.00
PL 2101		TELAIO FISSO a T MODANATO COMPLANARE INTERNO BATTUTA 25 mm MURO 47 mm	953	11.83 8.52
PL 2102		TELAIO FISSO a Z MODANATO COMPLANARE INT. BATTUTA 25 mm MURO 40 mm	1063	13.44 9.99
PL 2103		TELAIO FISSO a L MODANATO COMPLANARE INT.	844	10.21 4.72
PL 2104		TELAIO FISSO A Z DECORATO, FILO CERNIERA, BATTUTA 25 mm MURO 45 mm	980	10.21 4.72
PL 2105		TELAIO FISSO A Z DECORATO CON SCALINO, FILO CERNIERA BATTUTA 35 mm MURO 40 mm	1050	14.88 13.15
PL 2108		TELAIO FISSO A Z DECORATO CON SCALINO, FILO CERNIERA BATTUTA 25 mm MURO 40 mm	1006	13.80 9.21
PL 2109		TELAIO FISSO A L DECORATO CON SCALINO	840	10.04 4.39
PL 2121		TELAIO FISSO a Z FILO CERNIERA, BATTUTA 30 mm MURO 45 mm	1001	13.93 10.81
PL 2122		TELAIO FISSO a Z MODANATO COMPLANARE INT. BATTUTA 45 mm MURO 40 mm	1149	15.50 20.43
PL 2124		TELAIO FISSO a Z BATTUTA 70 mm MURO 40 mm	1340	18.36 44.14
PL 2138		TRAVERSO DA 92mm PER FISSI ED ANTE RAGGIATE FISSAGGIO CON VITI	1238	12.54 21.25
PL 2148		ZOCCOLO VETRO INF. DA 80 mm - SPAZIO VETRO 25 mm SEZ. 52,5 mm	1285	20.34 26.58
PL 2151		ANTA MODANATA VETRO INFILARE SPAZIO VETRO 25mm	1195	17.31 13.73
PL 2152		FASCIA MODANATA VETRO INFILARE DA 142mm - SPAZIO VETRO 25mm SEZ. 52,5 mm	1885	34.10 15.26

ART.	SAGOMA	DESCRIZIONE	PESO gr/m	Jxx cm ⁴ Jyy cm ⁴
PL 2153		TRAVERSO MODANATO VETRO INF. DA 80mm - SPAZIO VETRO 25mm SEZ. 52,5 mm	1328	21.26 28.62
PL 21148		ZOCCOLO MODANATO VETRO INF. DA 142mm - SPAZIO VETRO 25mm SEZ. 52,5 mm	1831	33.48 14.85
PL 21151		ANTA MODANATA BOMBATA VETRO AD INFILARE - SPAZIO VETRO 25mm	1225	19.66 14.33
PL 2202		TELAIO FISSO a Z BOMBATO COMPLANARE INT. BATTUTA 22 mm MURO 40 mm	1059	13.52 9.72
PL 2203		TELAIO FISSO a L BOMBATO COMPLANARE INT.	843	10.41 4.74
PL 22151		ANTA BOMBATA VETRO AD INFILARE SPAZIO VETRO 25mm	1231	18.10 13.80
PL 2336		ANTA MAGGIORATA DOPPIA BATTUTA APERTURA ESTERNA	1692	19.11 32.37
PL 2337		ANTA MAGGIORATA DOPPIA BATTUTA	1667	20.59 32.30
PL 2857		ANTA VETRO INFILARE ROMA	1110	14.25 9.57
PL 6097		RIDUTTORE VETRO DA 12 mm	246	- -
PL 1404		FERMAVETRO LISCIO DA 3.5mm	190	- -
PL 1407		FERMAVETRO LISCIO DA 7mm	206	- -
PL 1411		FERMAVETRO LISCIO DA 10.5mm	252	- -
PL 1414		FERMAVETRO LISCIO DA 14mm	257	- -
PL 1418		FERMAVETRO LISCIO DA 17.5mm	268	- -
PL 1421		FERMAVETRO LISCIO DA 21mm	290	- -

ART.	SAGOMA	DESCRIZIONE	PESO gr/m	Jxx cm ⁴ Jyy cm ⁴
PL 1425		FERMAVETRO LISCIO DA 24.5mm	304	- -
PL 1428		FERMAVETRO LISCIO DA 27.5mm	312	- -
PL 1432		FERMAVETRO LISCIO DA 31.7mm	331	- -
PL 14121		FERMAVETRO RETTO CON PORTAGUARNIZIONE DA 21 mm	280	- -
PL 14125		FERMAVETRO RETTO CON PORTAGUARNIZIONE DA 25 mm	313	- -
PL 14128		FERMAVETRO RETTO CON PORTAGUARNIZIONE DA 27.5 mm	323	- -
PL 14132		FERMAVETRO RETTO CON PORTAGUARNIZIONE DA 32 mm	338	- -
PL 1511		FERMAV. RAGGIATO DA 10.2mm	238	- -
PL 1514		FERMAV. RAGGIATO DA 14mm	247	- -
PL 1518		FERMAV. RAGGIATO DA 17.5mm	257	- -
PL 1521		FERMAV. RAGGIATO DA 21mm	279	- -
PL 1525		FERMAV. RAGGIATO DA 24.5mm	290	- -
PL 1528		FERMAV. RAGGIATO DA 27.5mm	301	- -
PL 1532		FERMAV. RAGGIATO DA 31.7mm	317	- -
PL 1818		FERMAV. SMUSSATO DA 17.5mm	236	- -
PL 1821		FERMAV. SMUSSATO DA 21mm	258	- -

ART.	SAGOMA	DESCRIZIONE	PESO gr/m	Jxx cm ⁴ Jyy cm ⁴
PL 1825		FERMAV. SMUSSATO DA 24.5mm	270	- -
PL 1828		FERMAV. SMUSSATO DA 27.5mm	279	- -
PL 1832		FERMAV. SMUSSATO DA 31.7mm	296	- -
PL 1928		FERMAV. MODANATO DA 27.5mm	298	- -
PL 1932		FERMAV. MODANATO DA 31.7mm	317	- -
PL 1325		FERMAVETRO GUIDA OSCURANTI "EASYSUN"	348	- -
R 3521		DOGA SEZIONE 20 mm PER 120 mm	1001	- -
AS 1000		ASTINA	119	- -
AS 1001R		GOCCIOLATOIO	127	- -
AS 4864		CASSONETTO INFERIORE E SUPERIORE	1218	- -
AS 4865		CASSONETTO FRONTALE	1110	- -
AS 48111		SCURETTO	555	- -
AS 48167		PROFILO COPRICAVA BOMBATO PER MONOBLOCCO	160	- -
1484		DOGA SEZIONE 19.5 mm PER 100 mm	982	- -
ET00633		SCURETTO PICCOLO	390	- -

I pesi dei profilati indicati in tabella sono teorici e possono scostarsi da quelli reali fino ad un massimo fattore moltiplicativo di 1,10

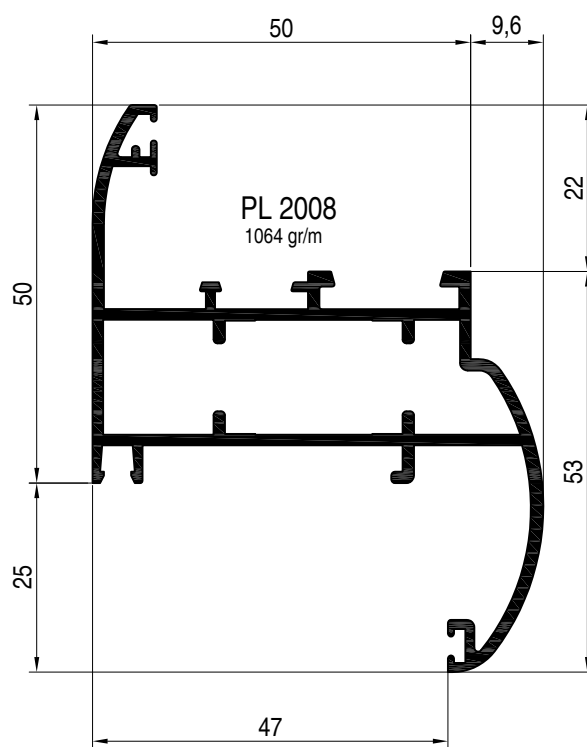
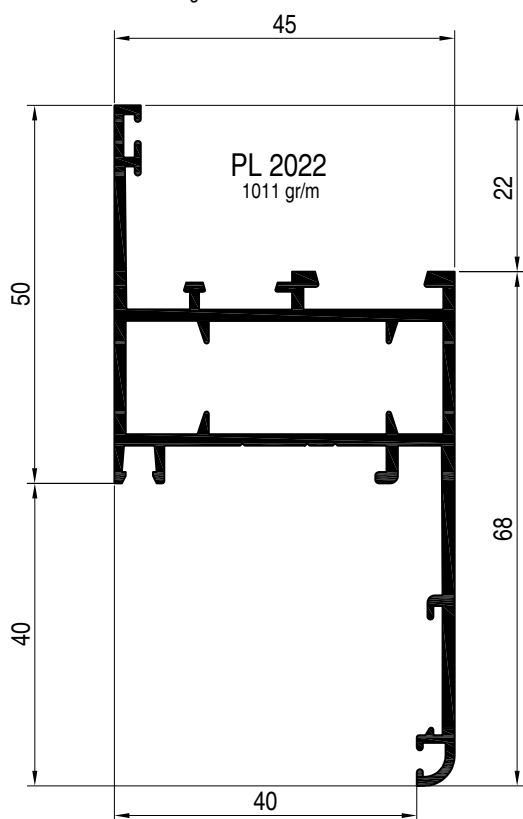
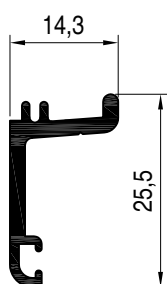
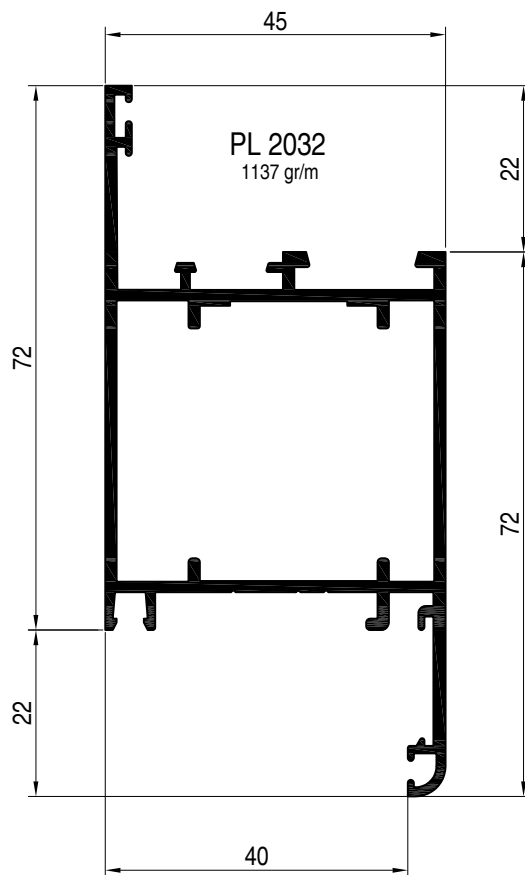
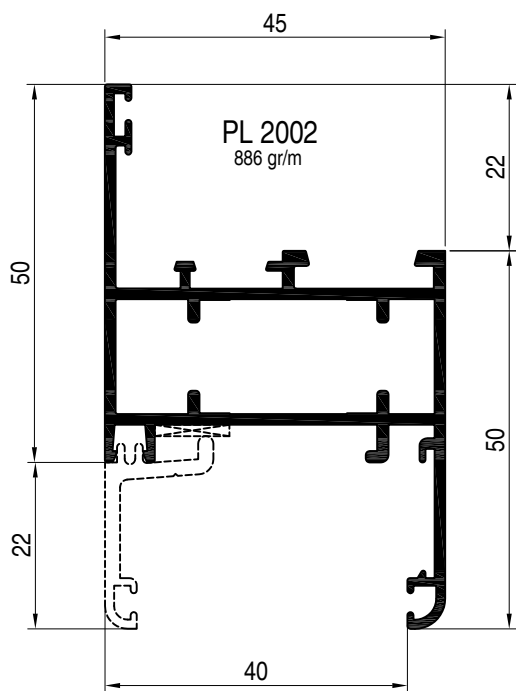

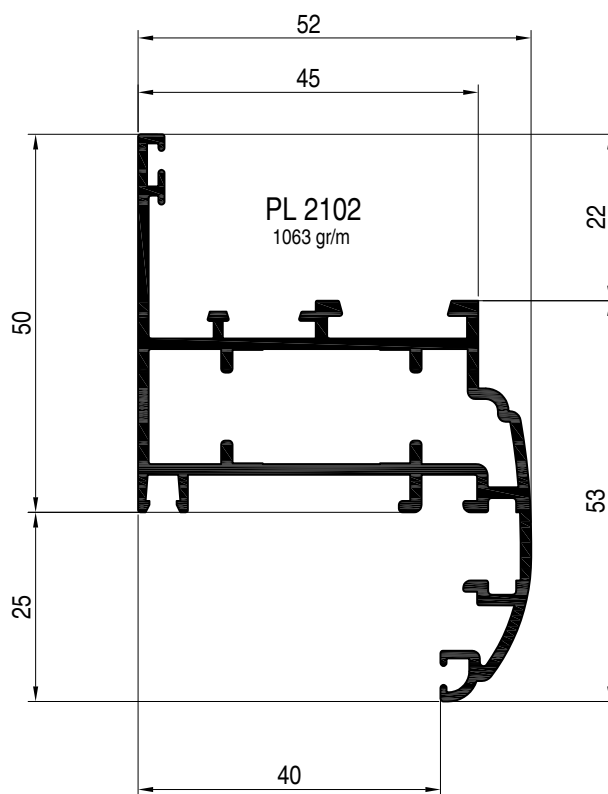
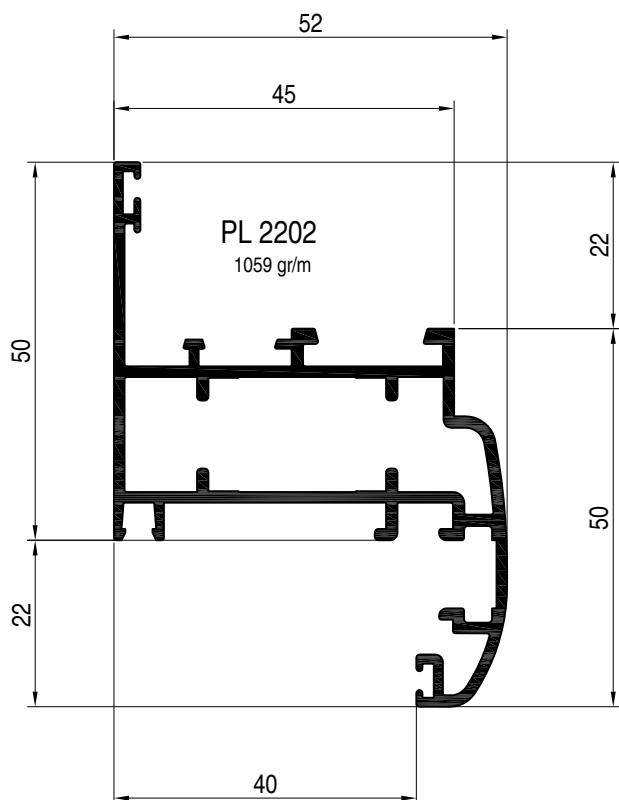
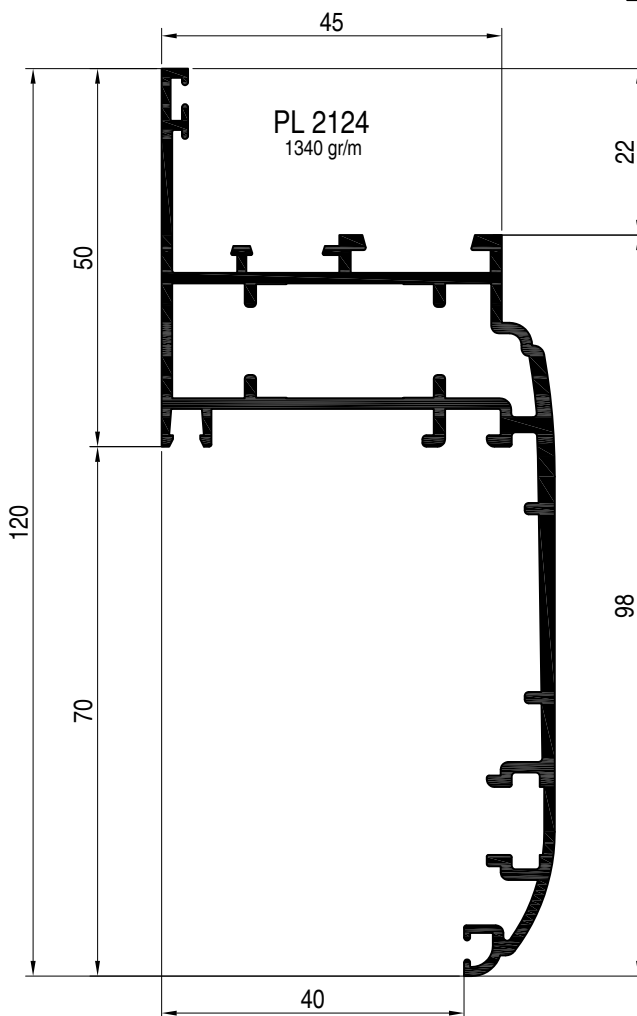
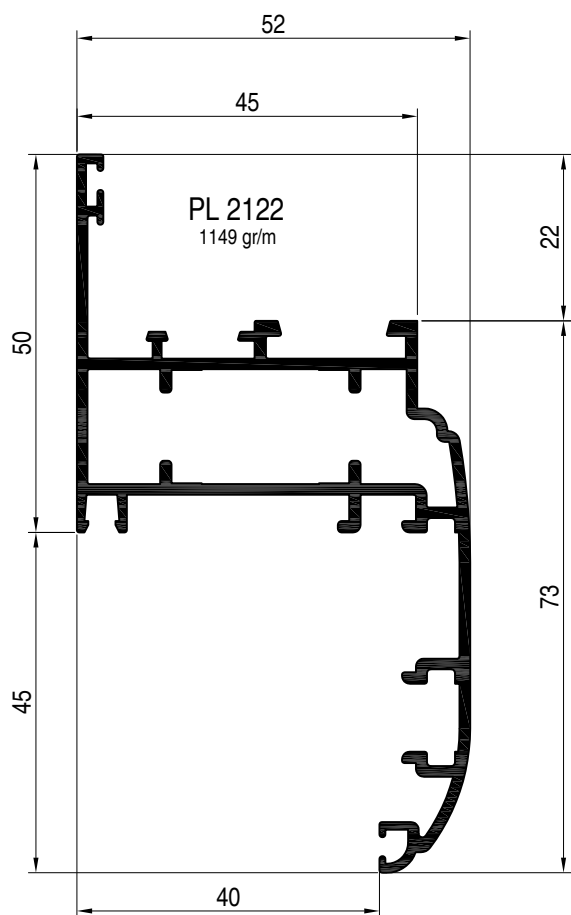

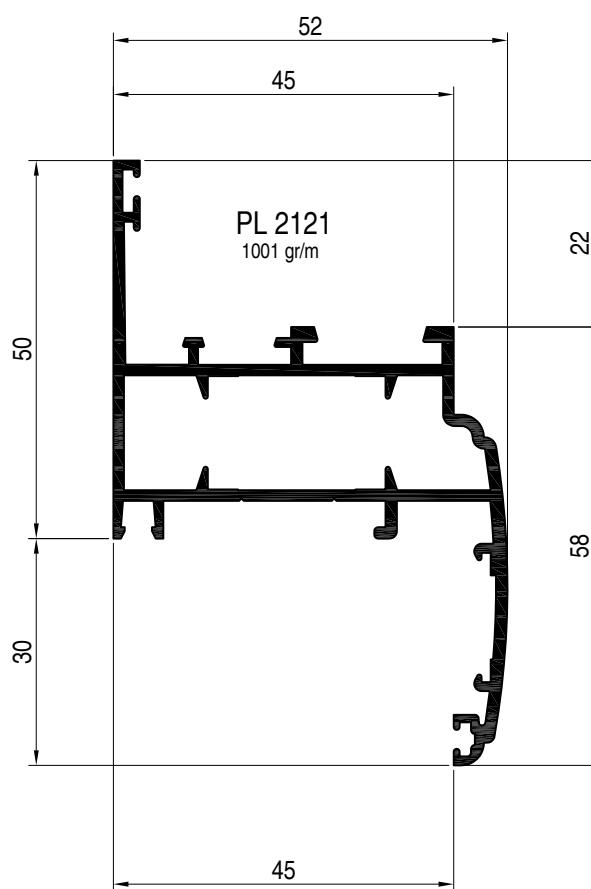
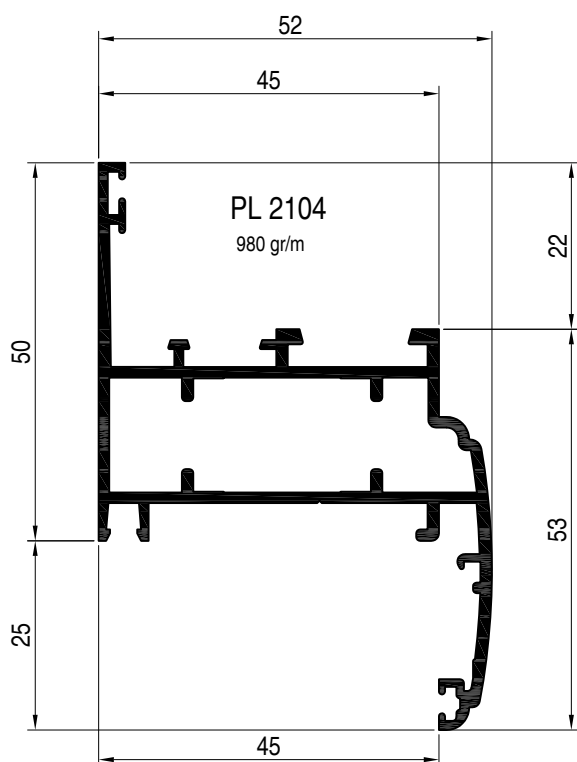
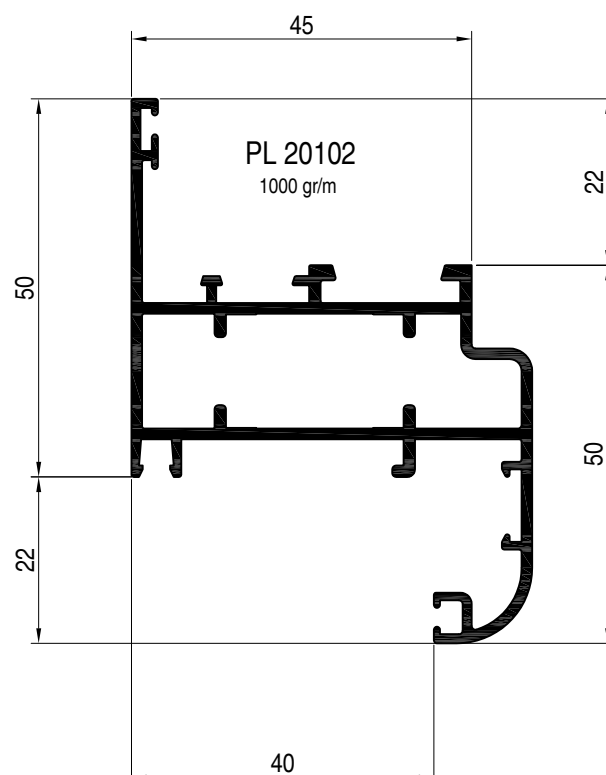
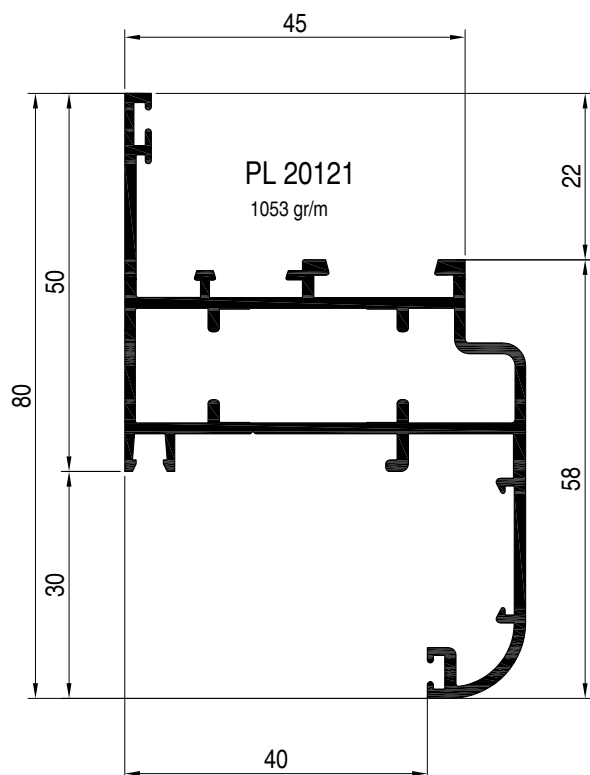

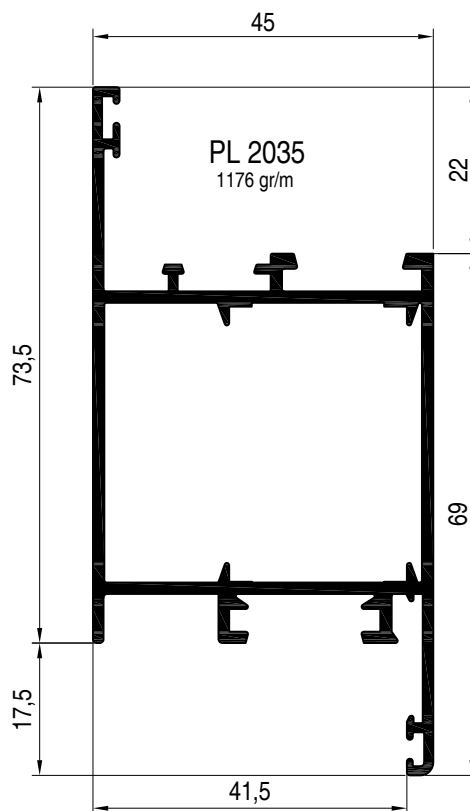
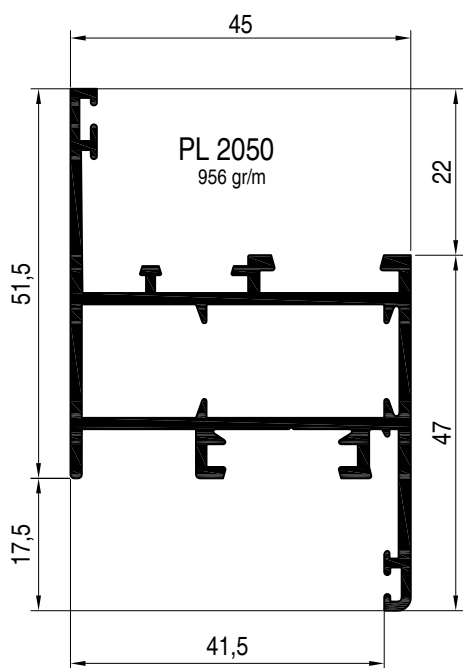
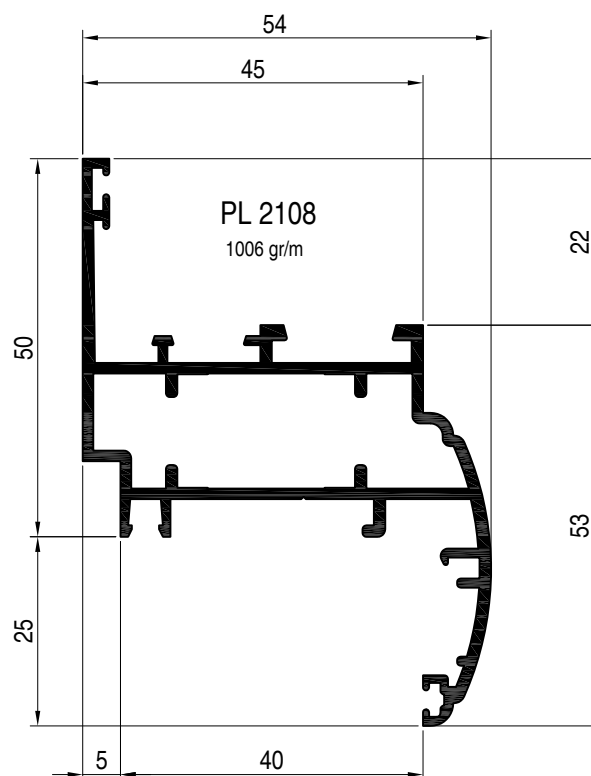
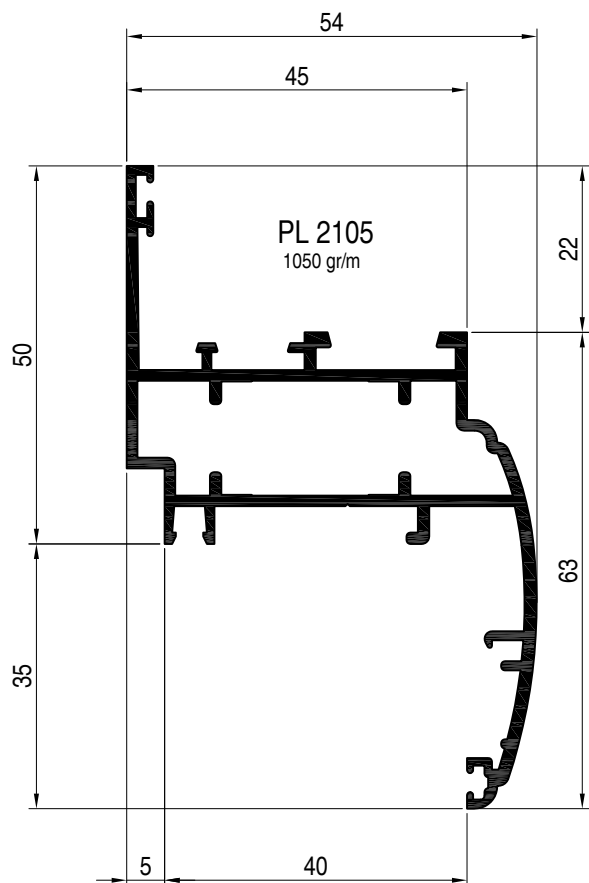

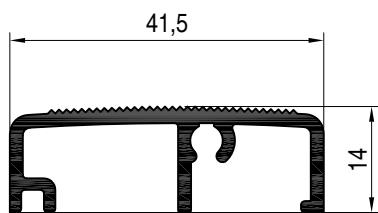

PL 2099
511 gr/m

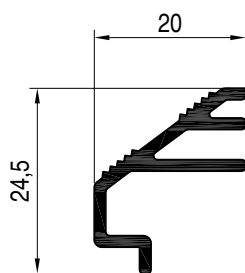

PL20126
260 gr/m

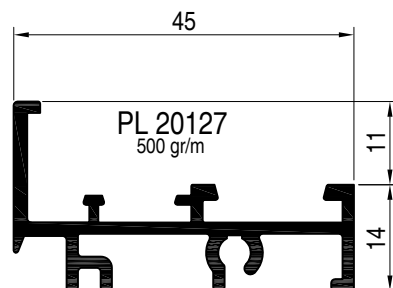

PL 20127
500 gr/m

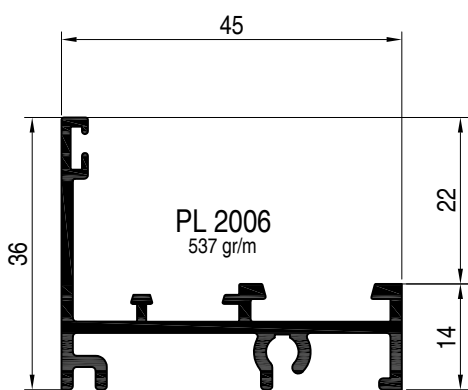

PL 2006
537 gr/m

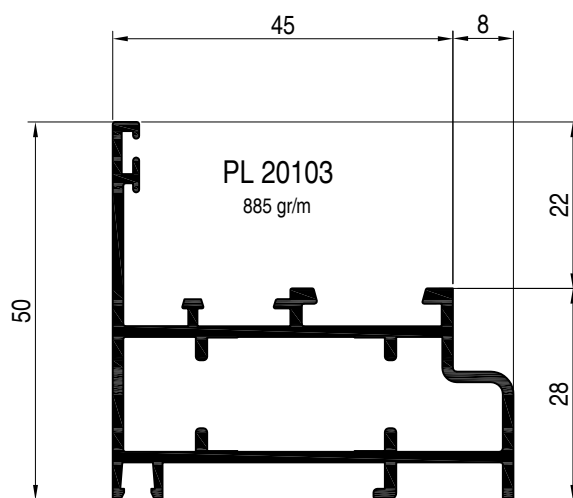

PL 20103
885 gr/m

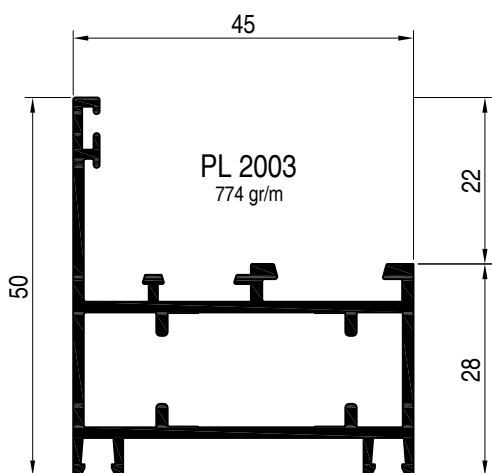

PL 2003
774 gr/m

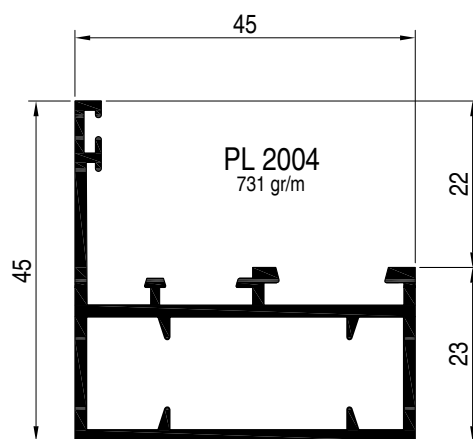

PL 2004
731 gr/m

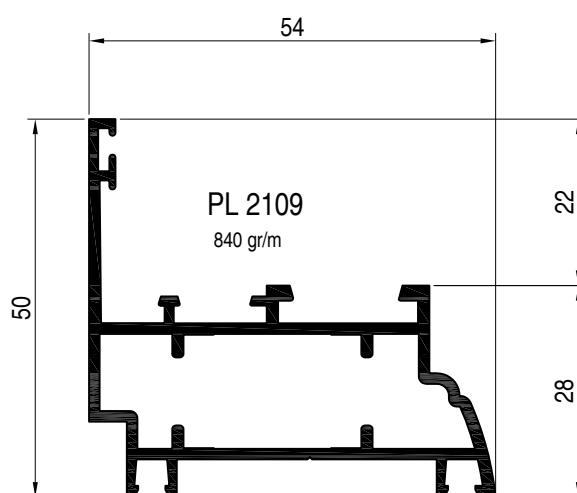
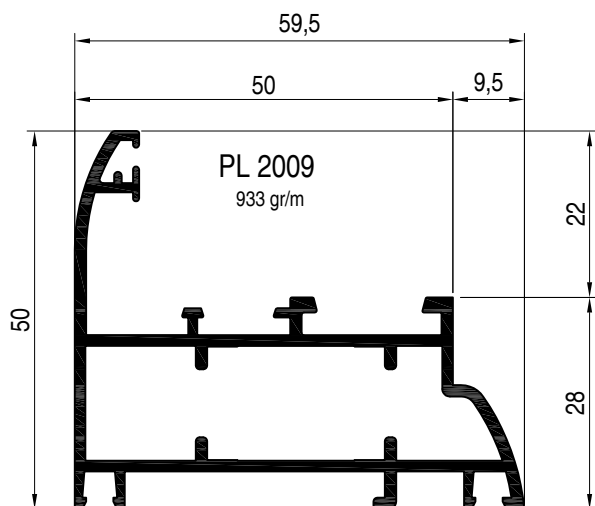
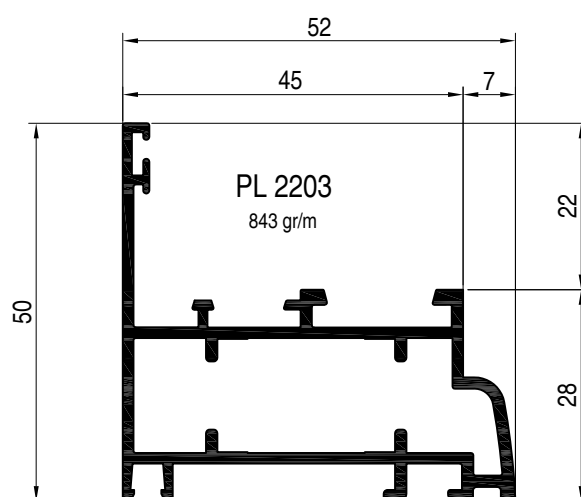
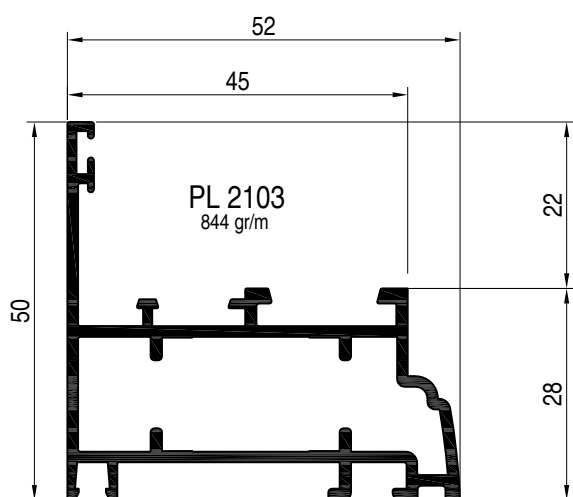
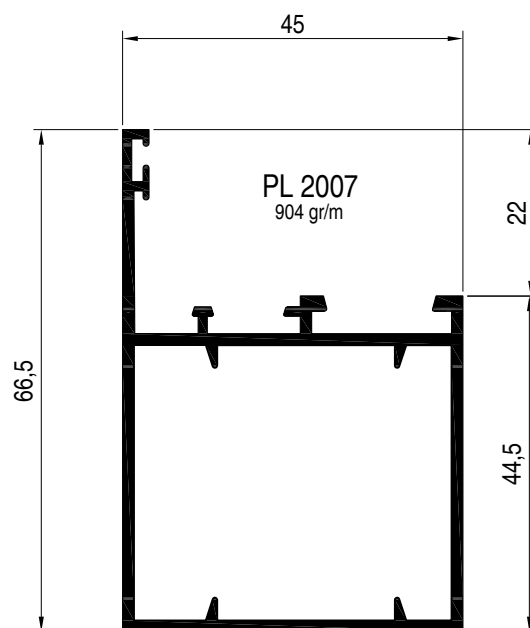
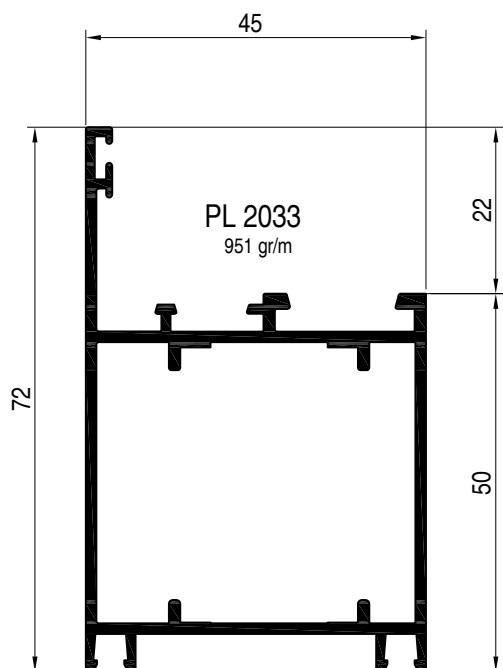

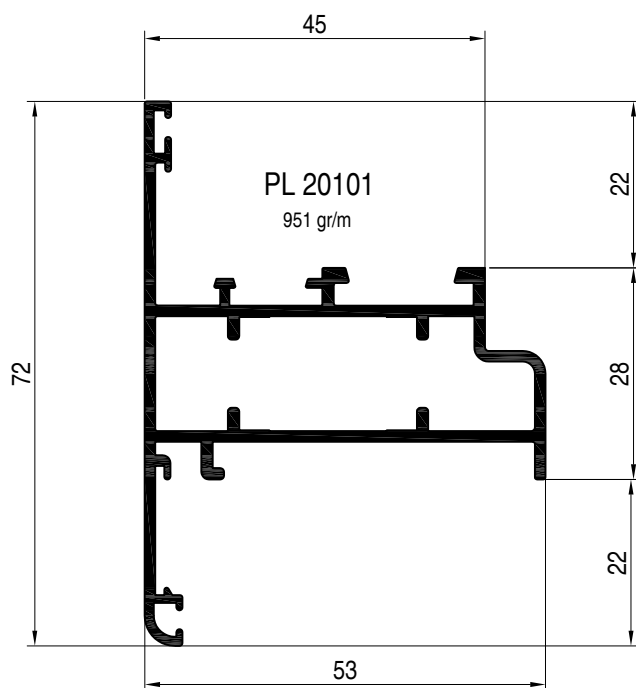
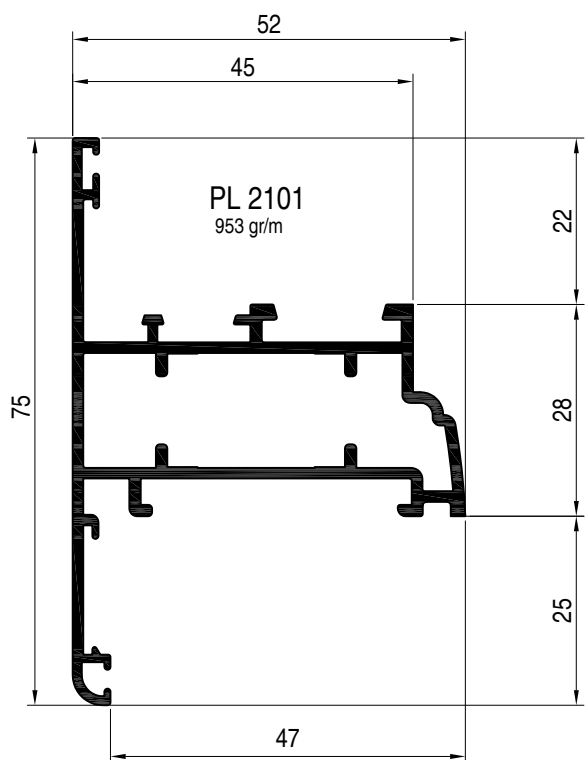
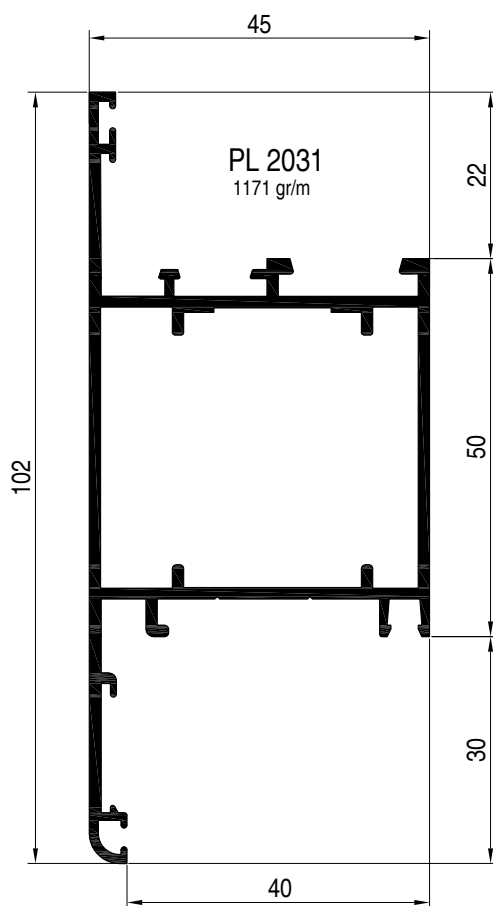
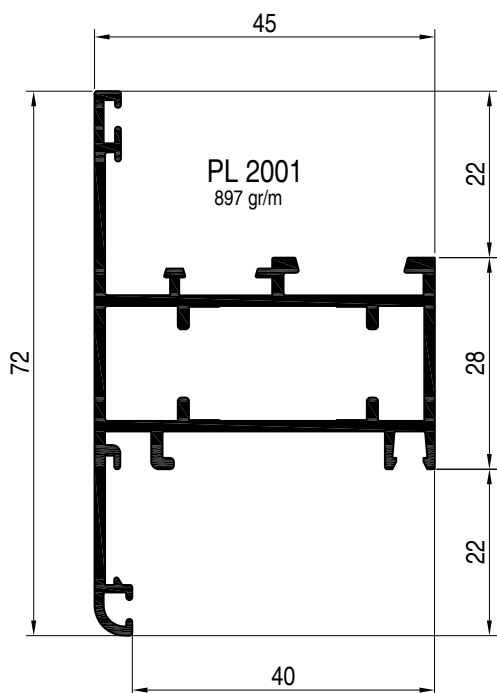

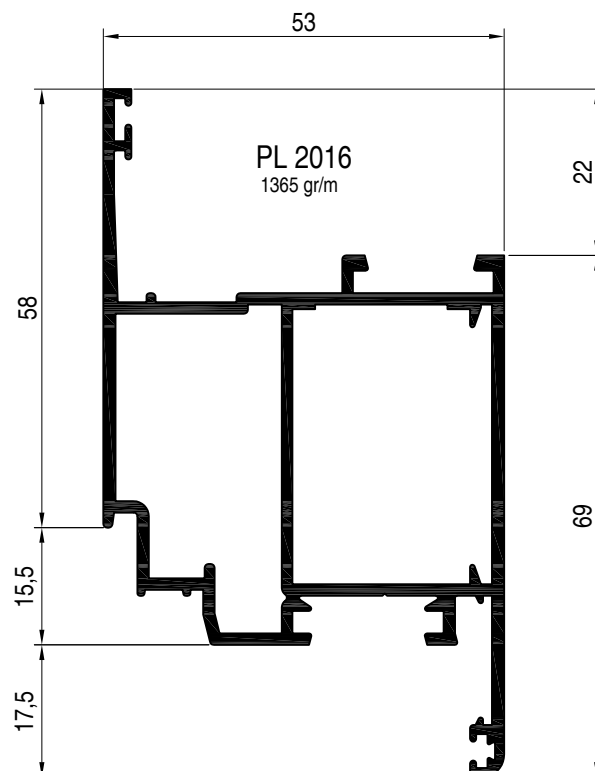
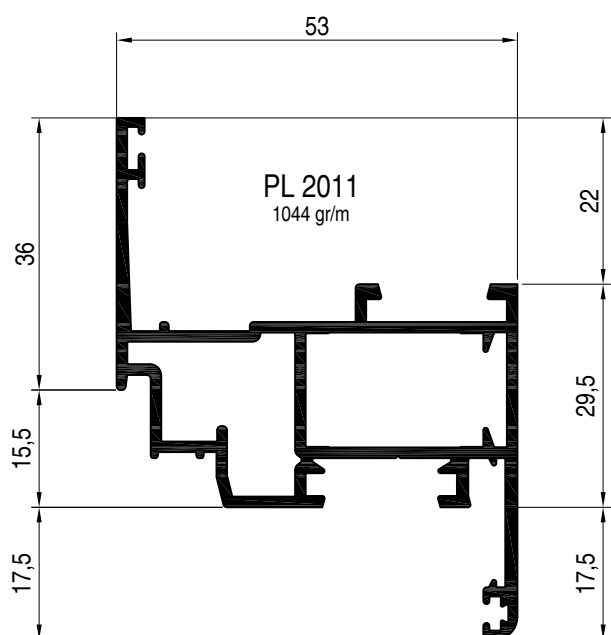
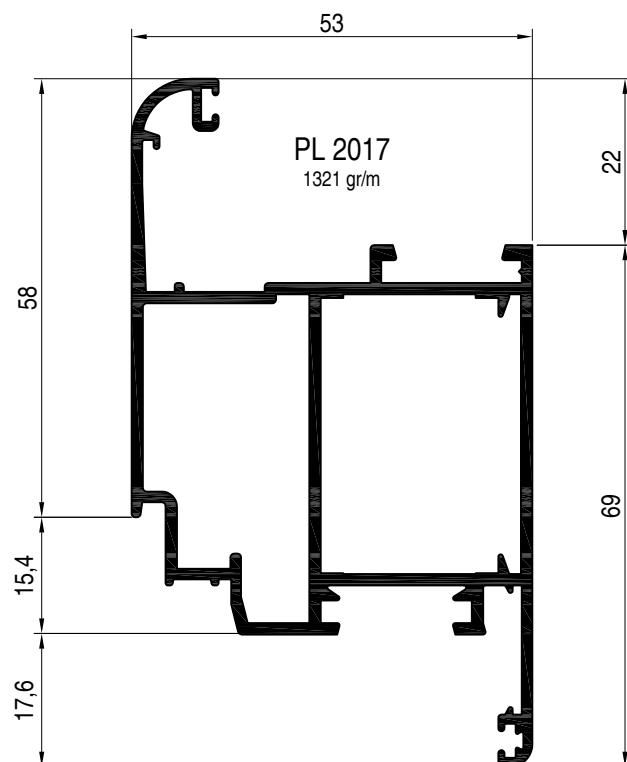
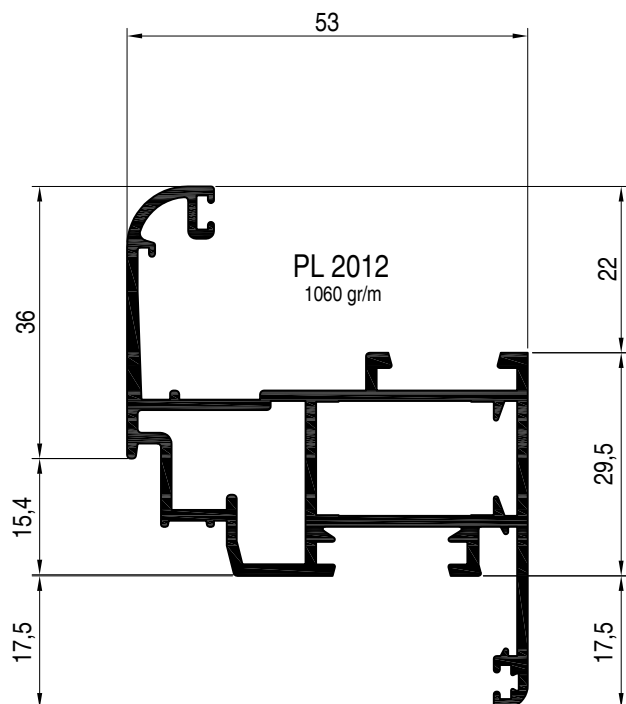

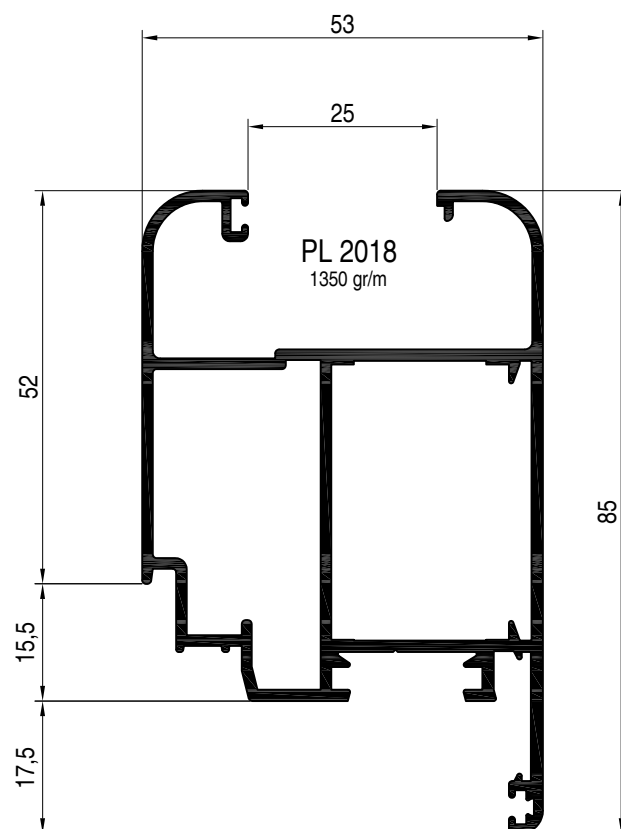
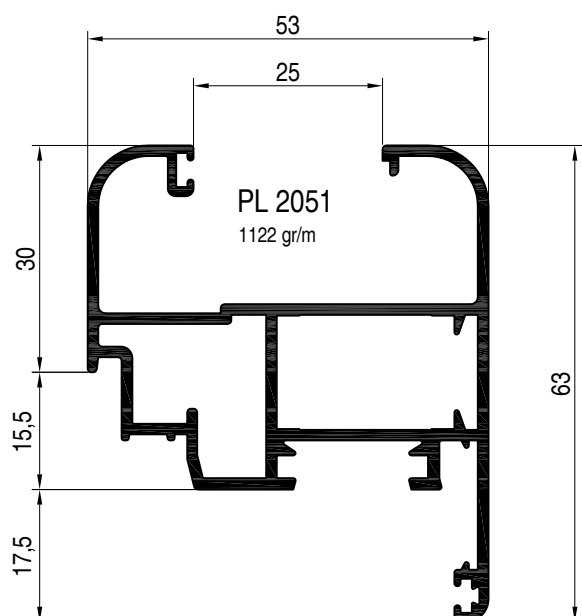
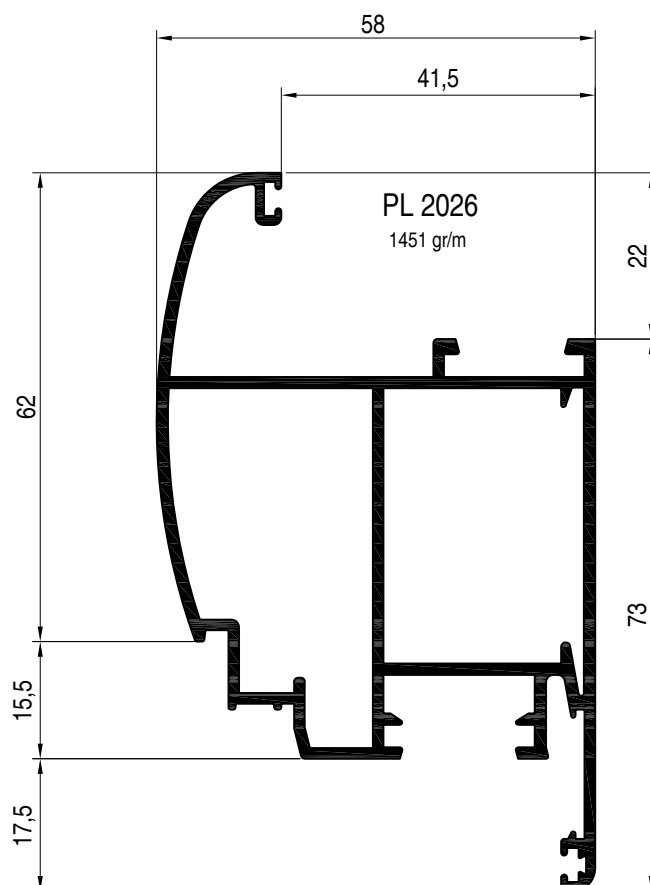
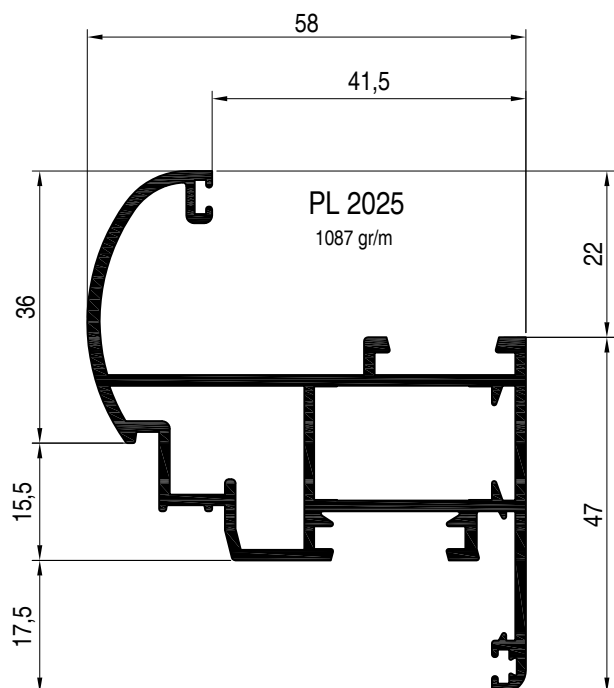

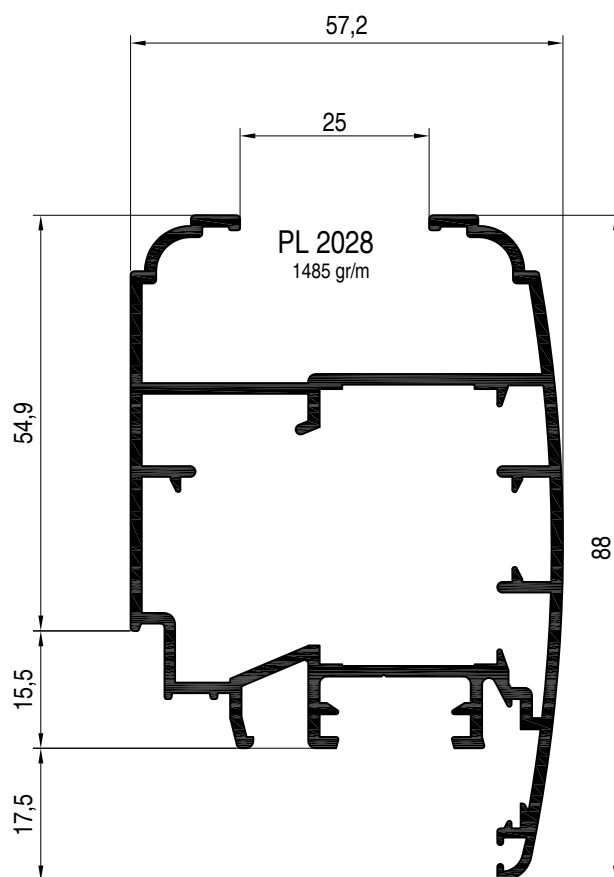
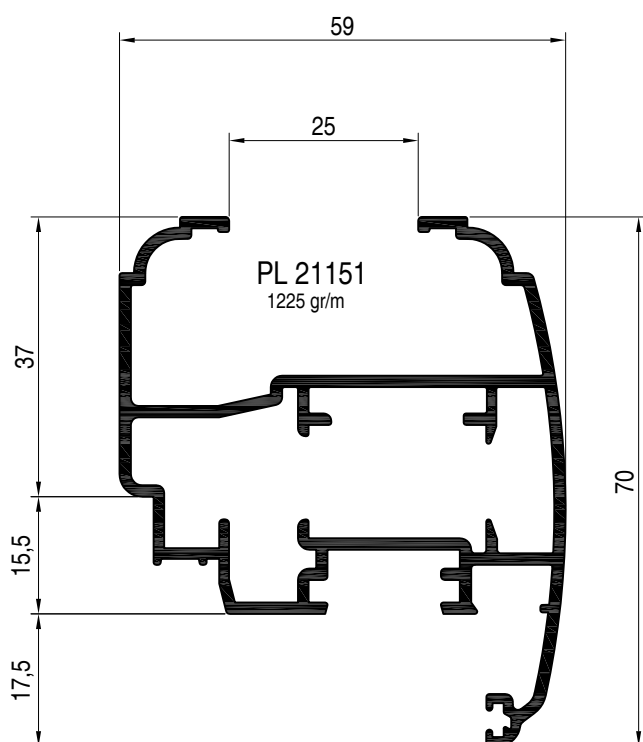
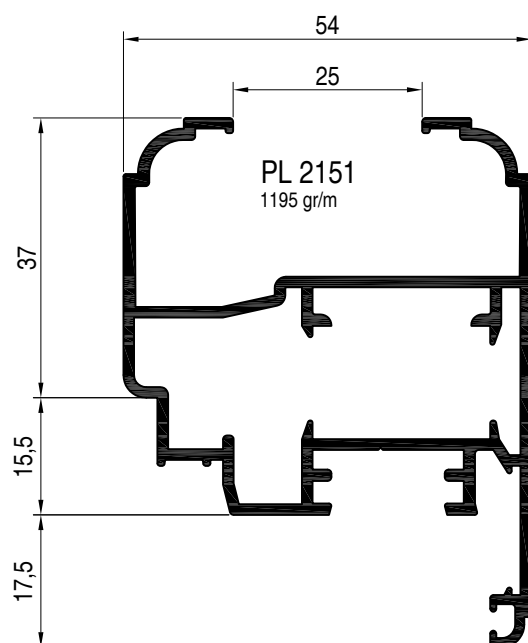
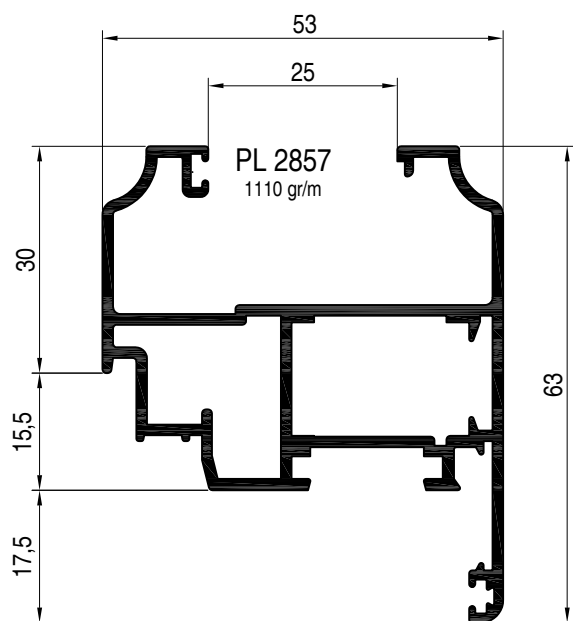

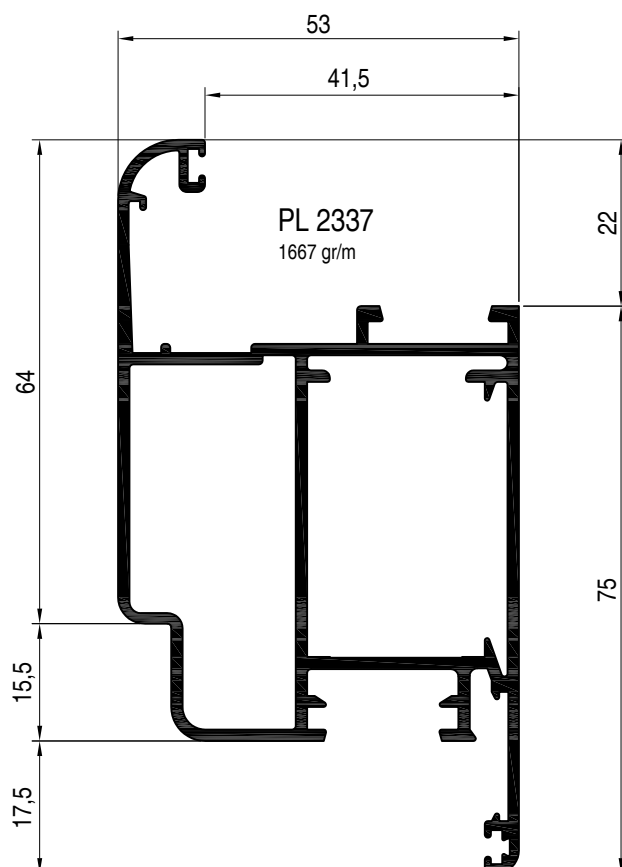
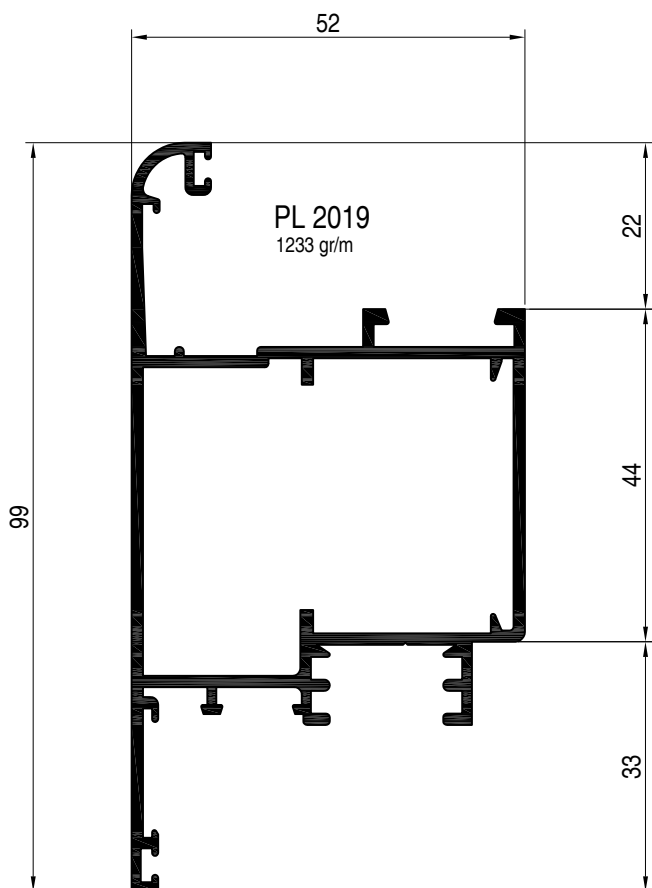
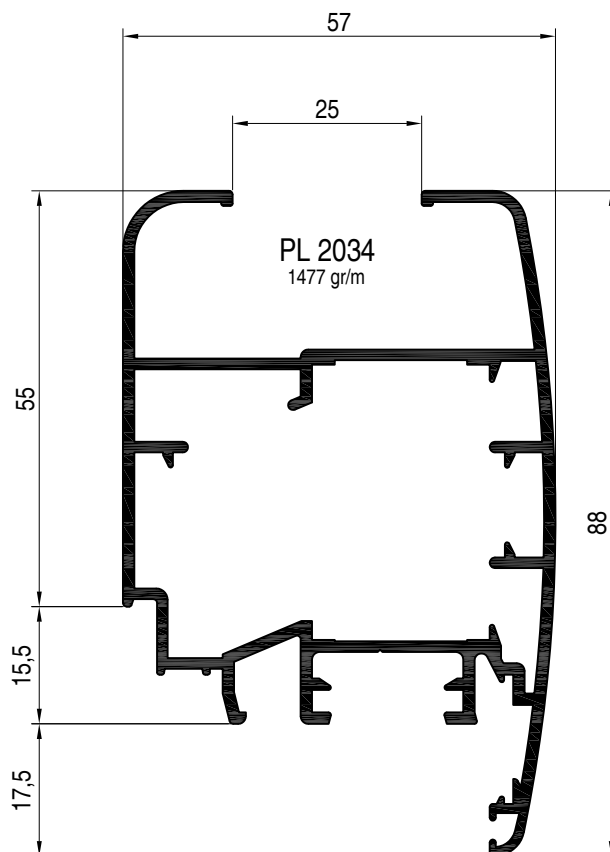
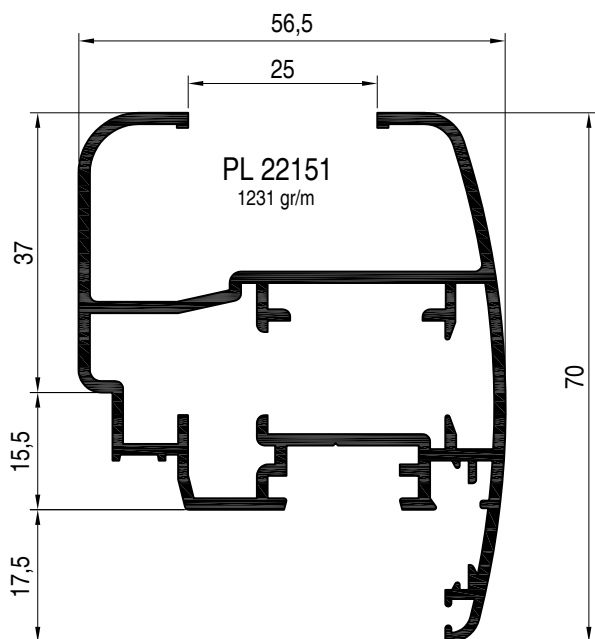

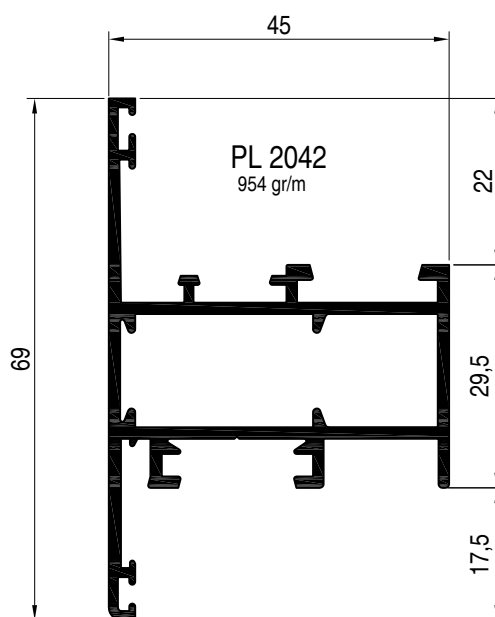
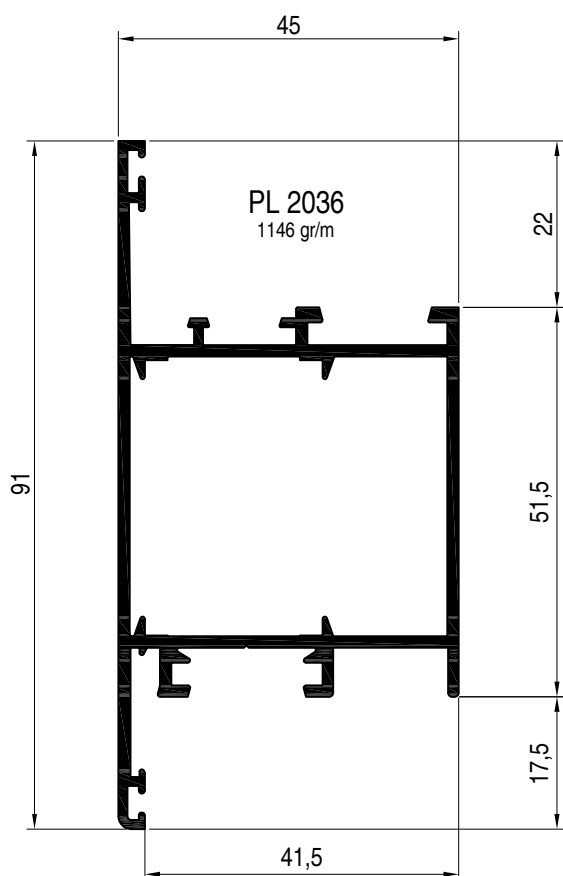
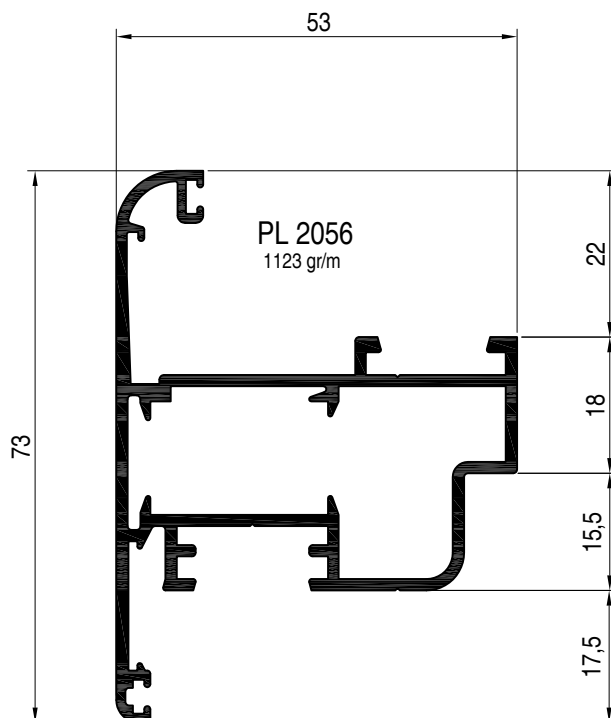
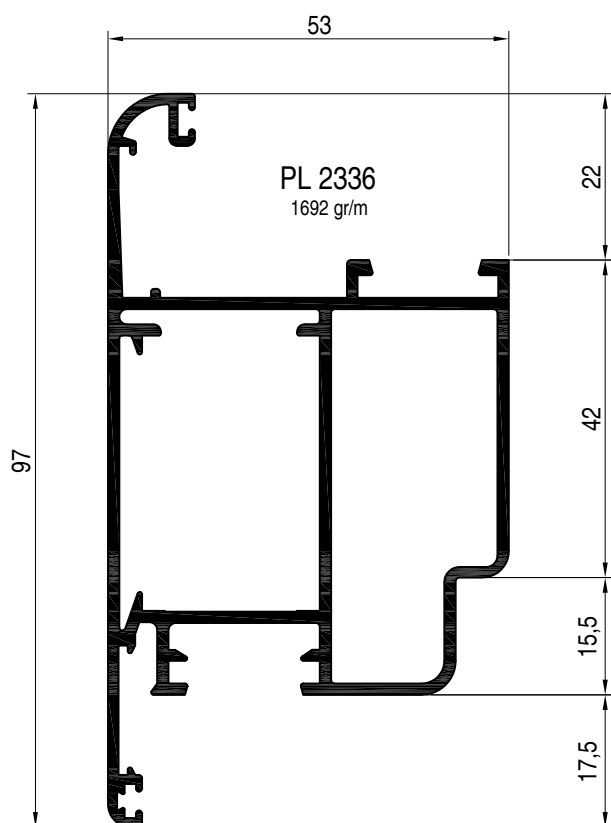

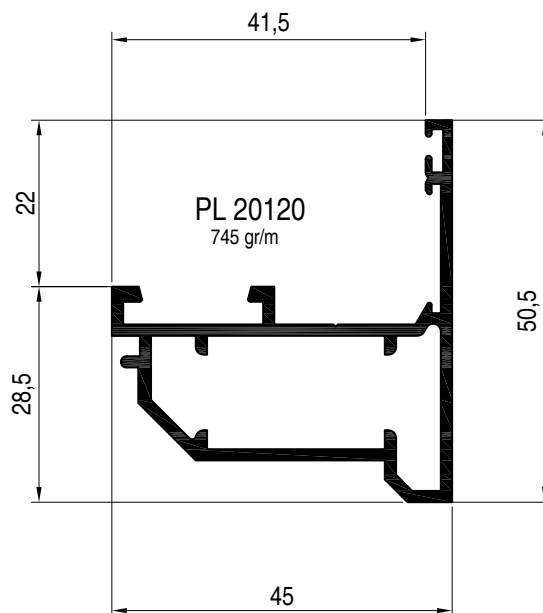
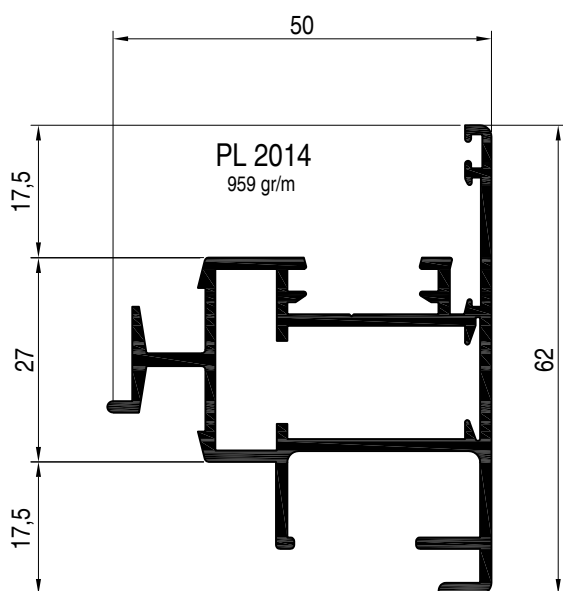
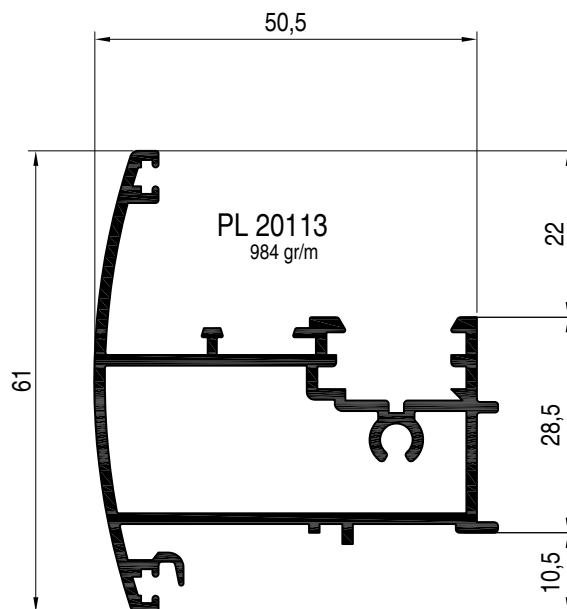
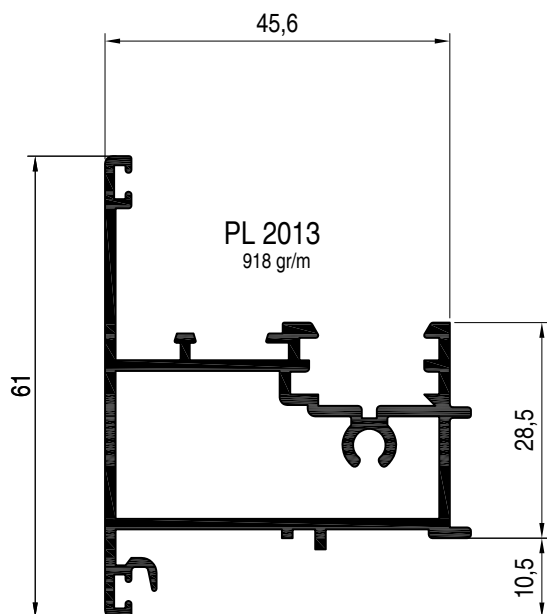

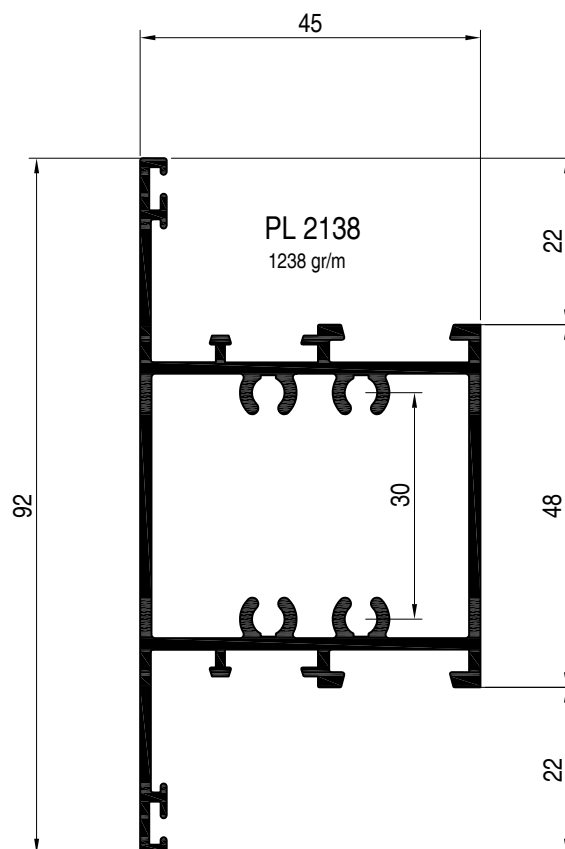
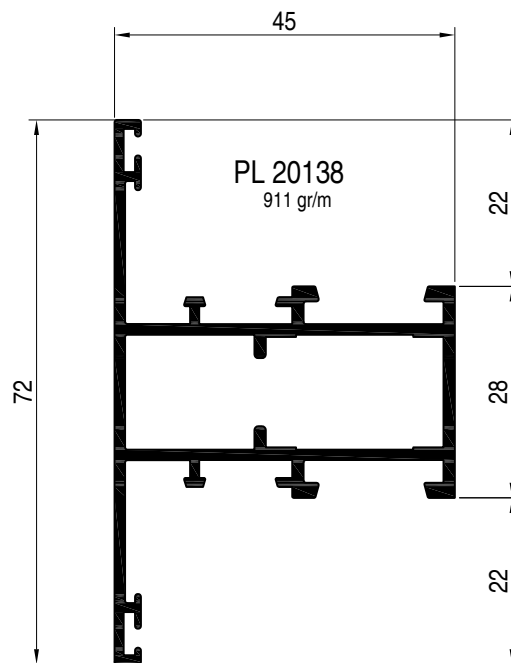
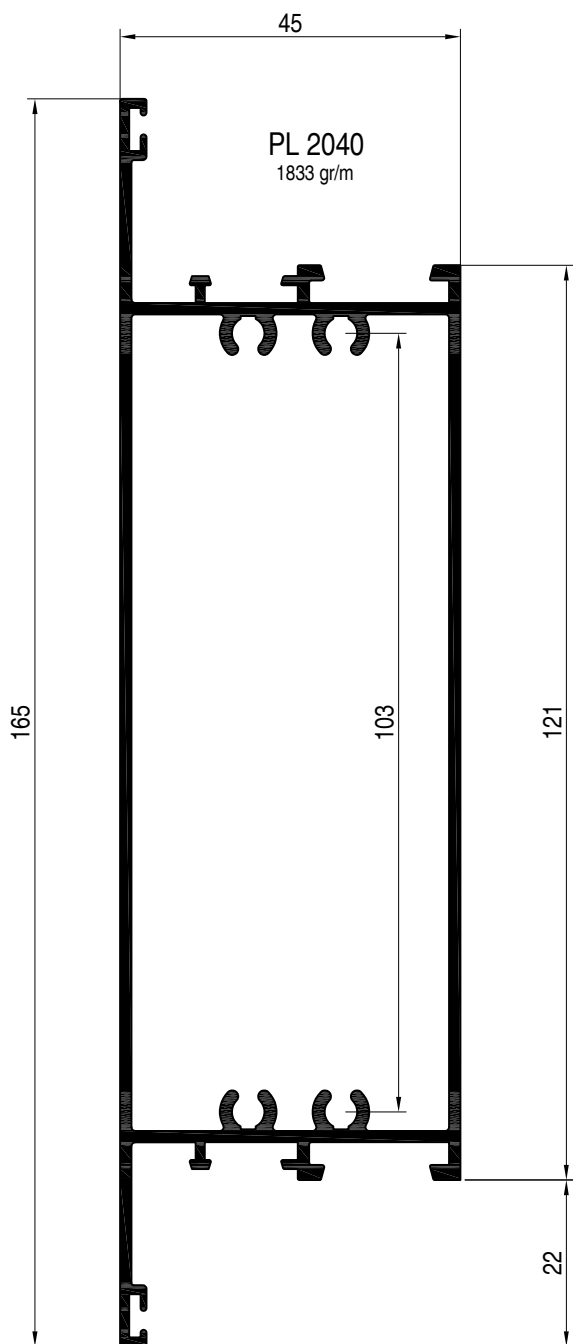

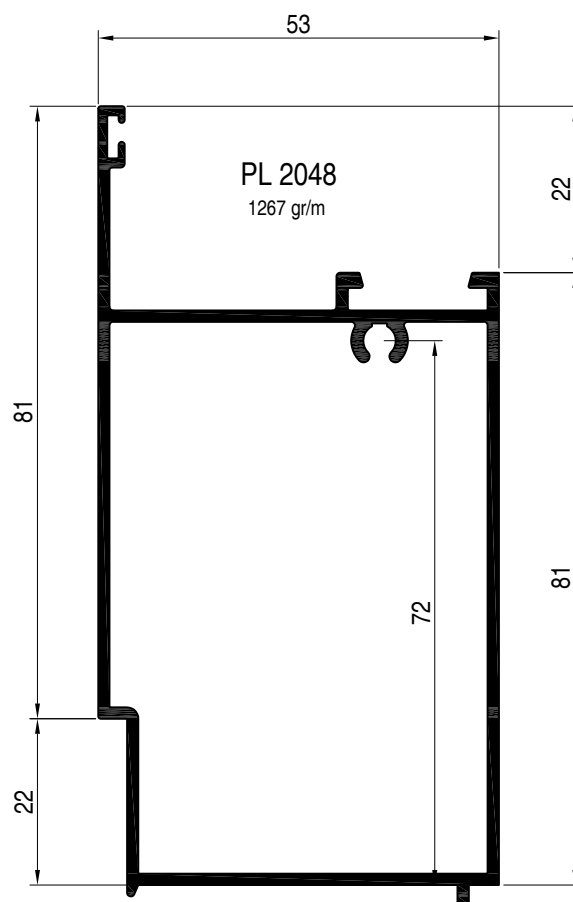
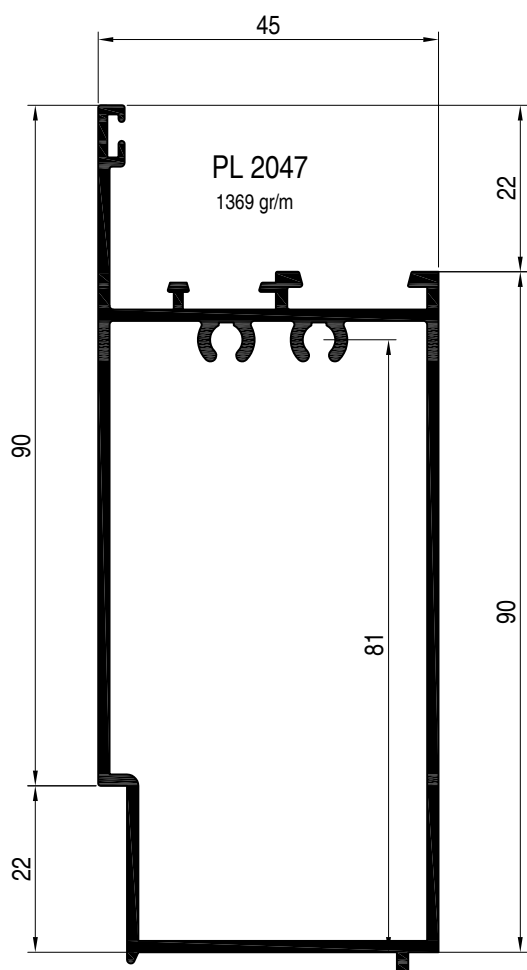
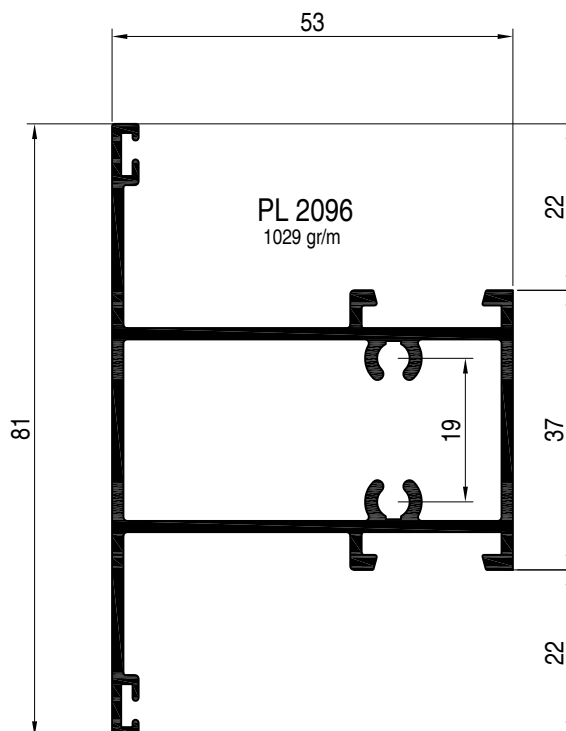
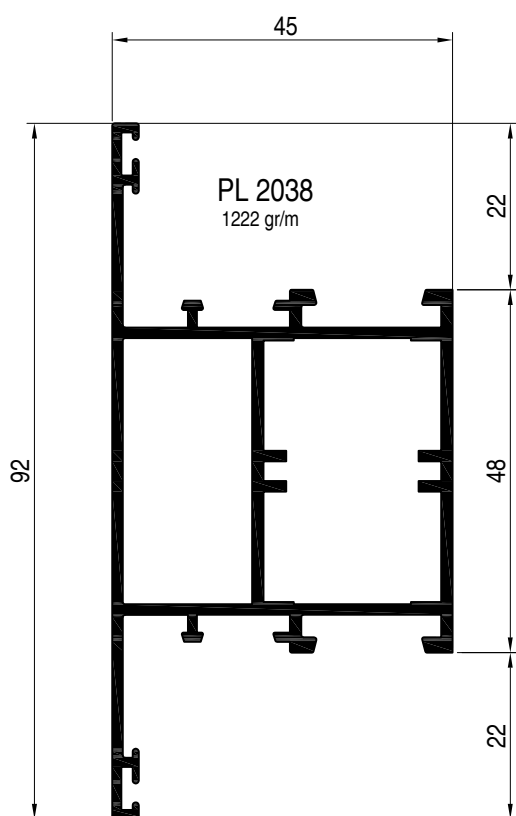

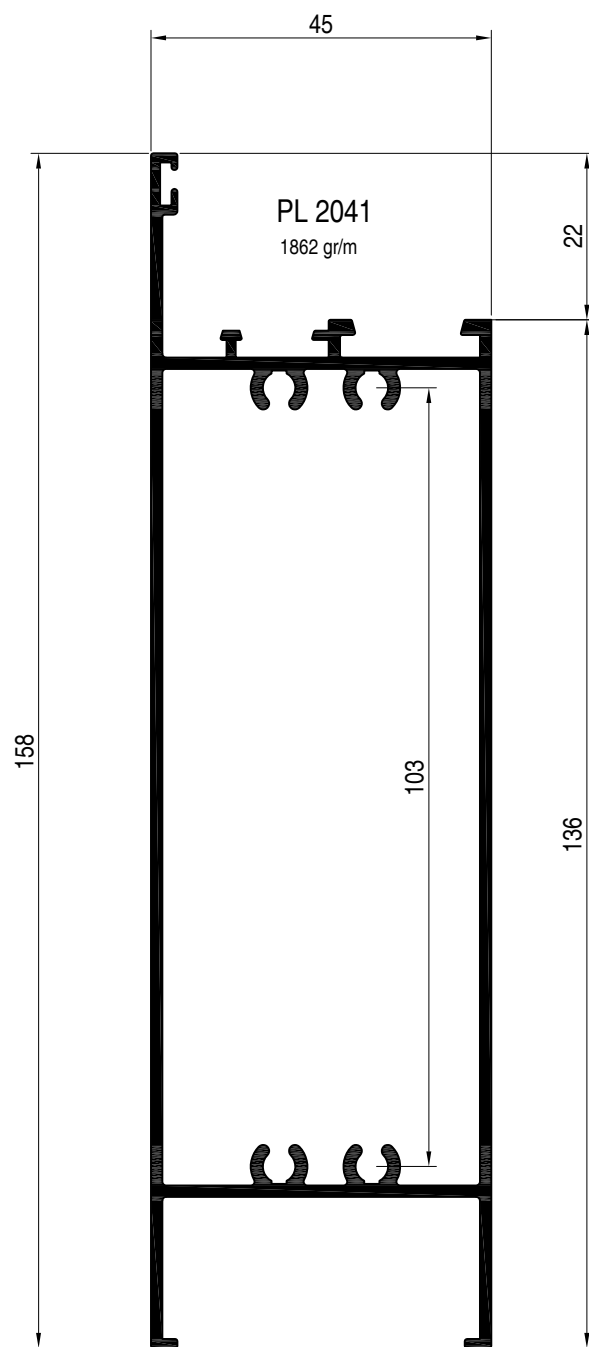

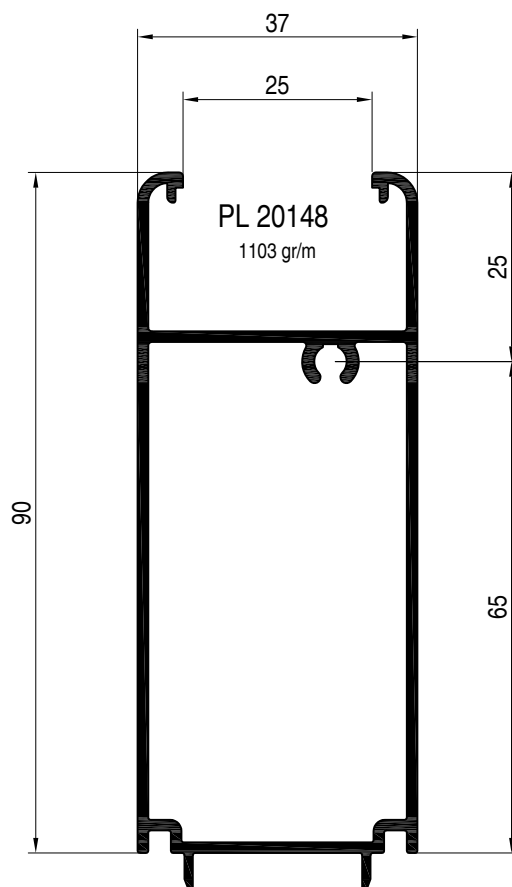
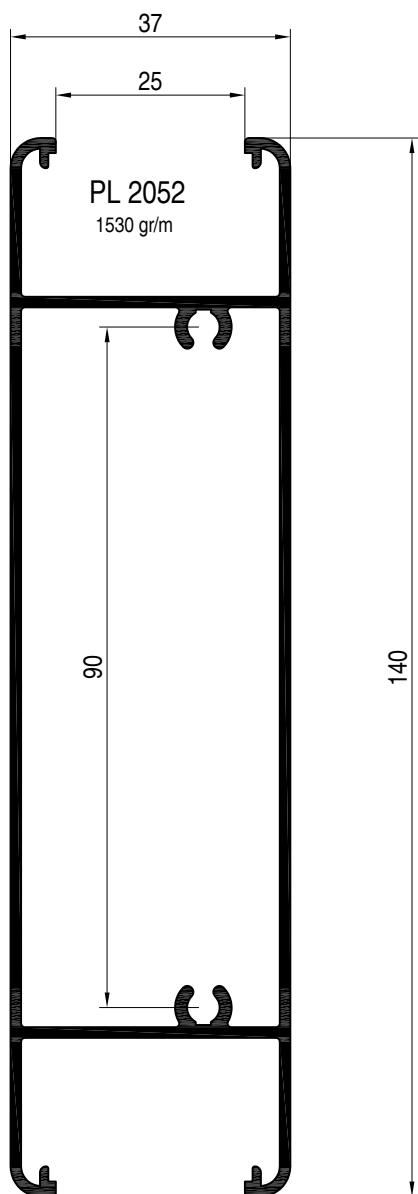
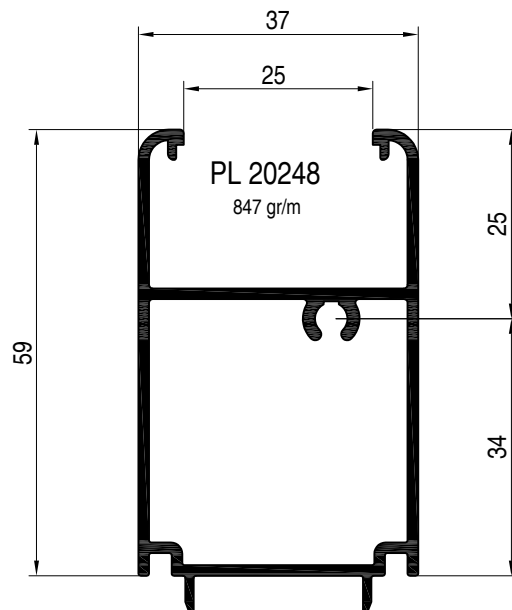
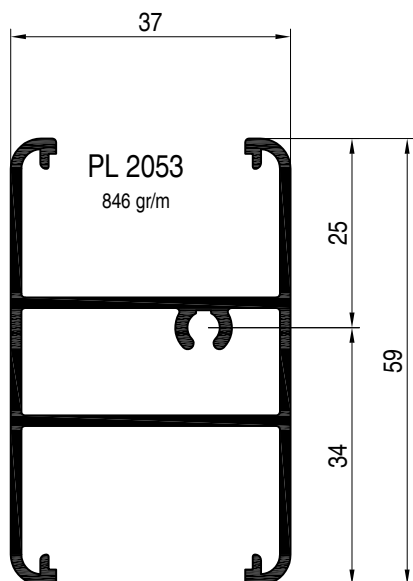

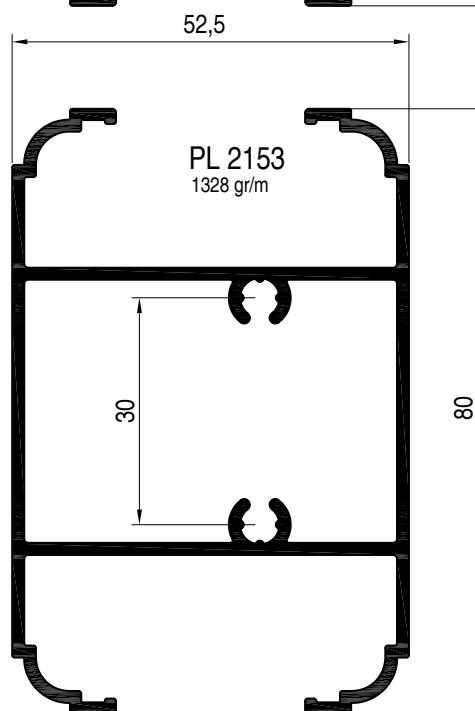
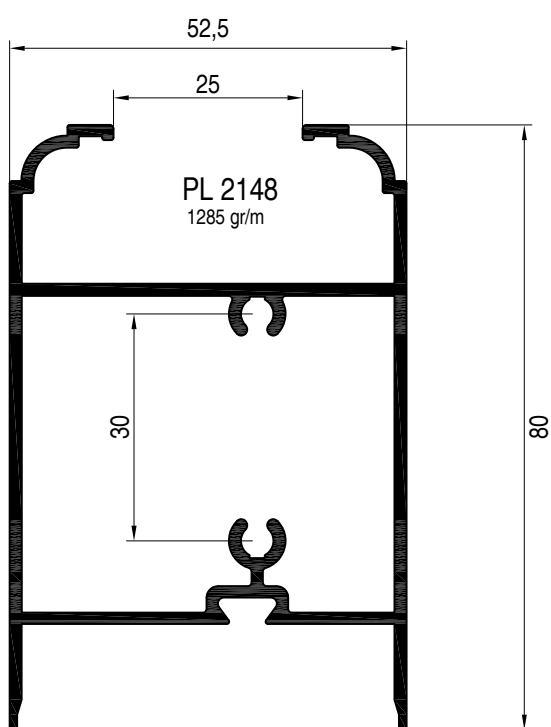
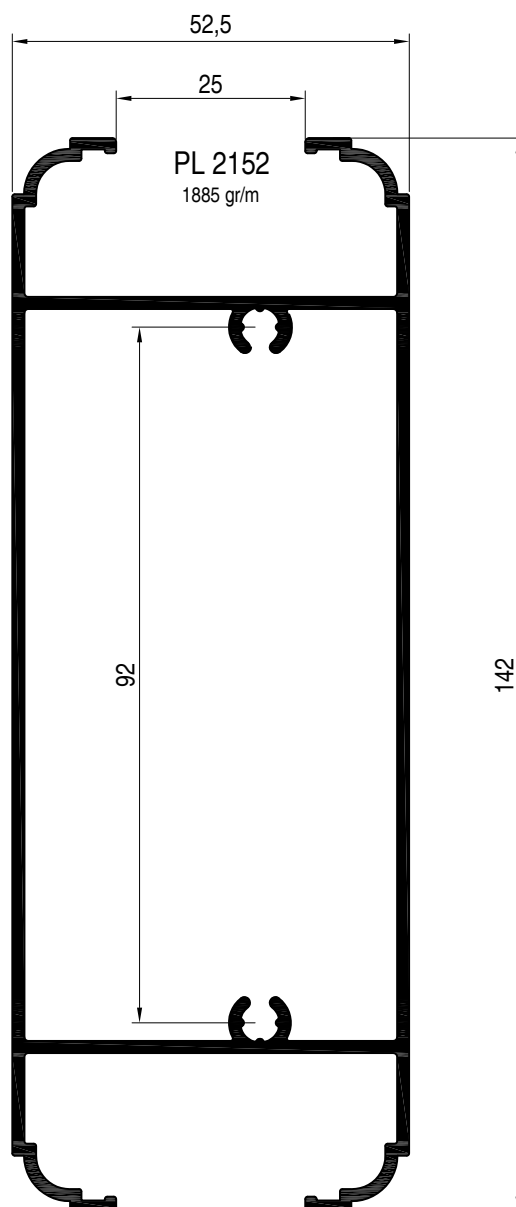
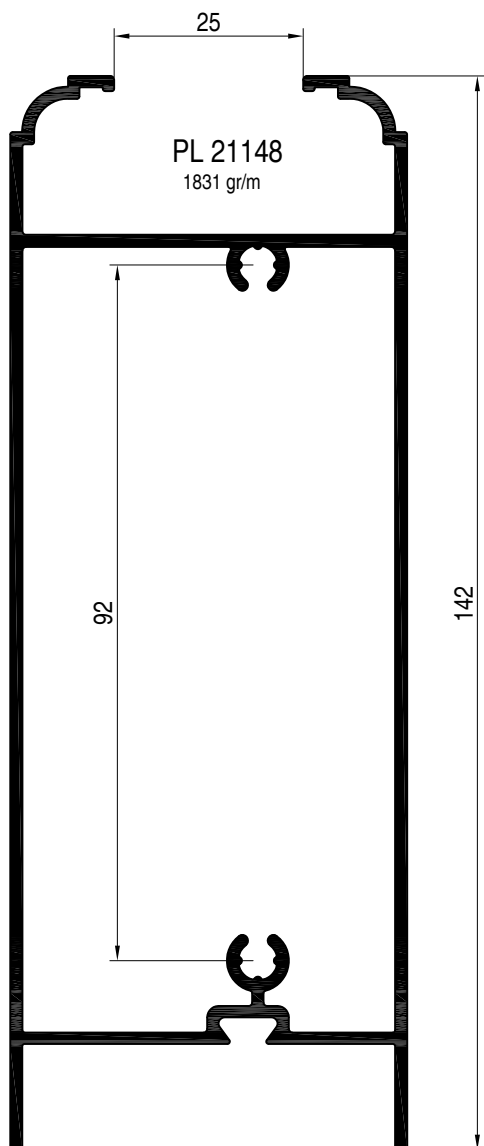

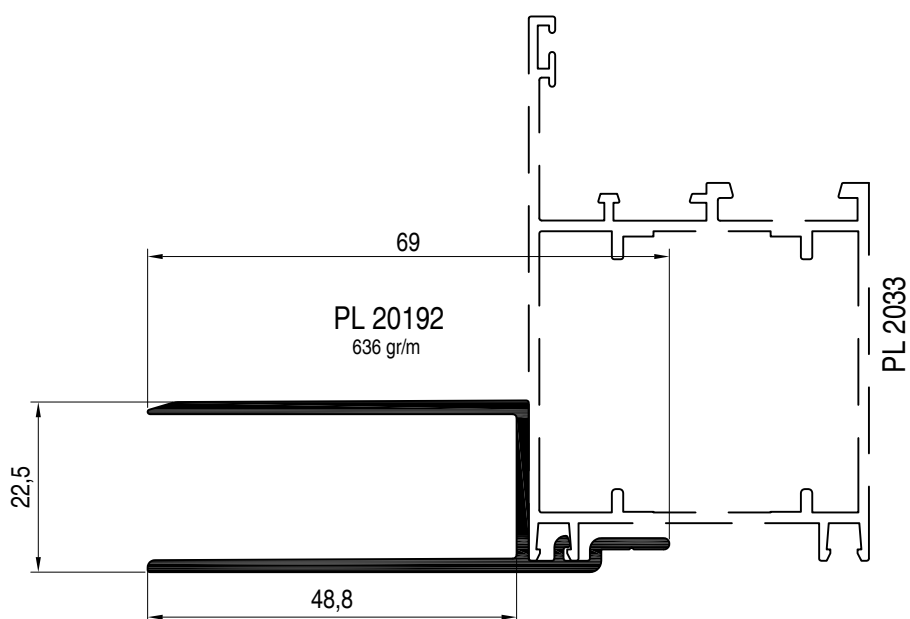
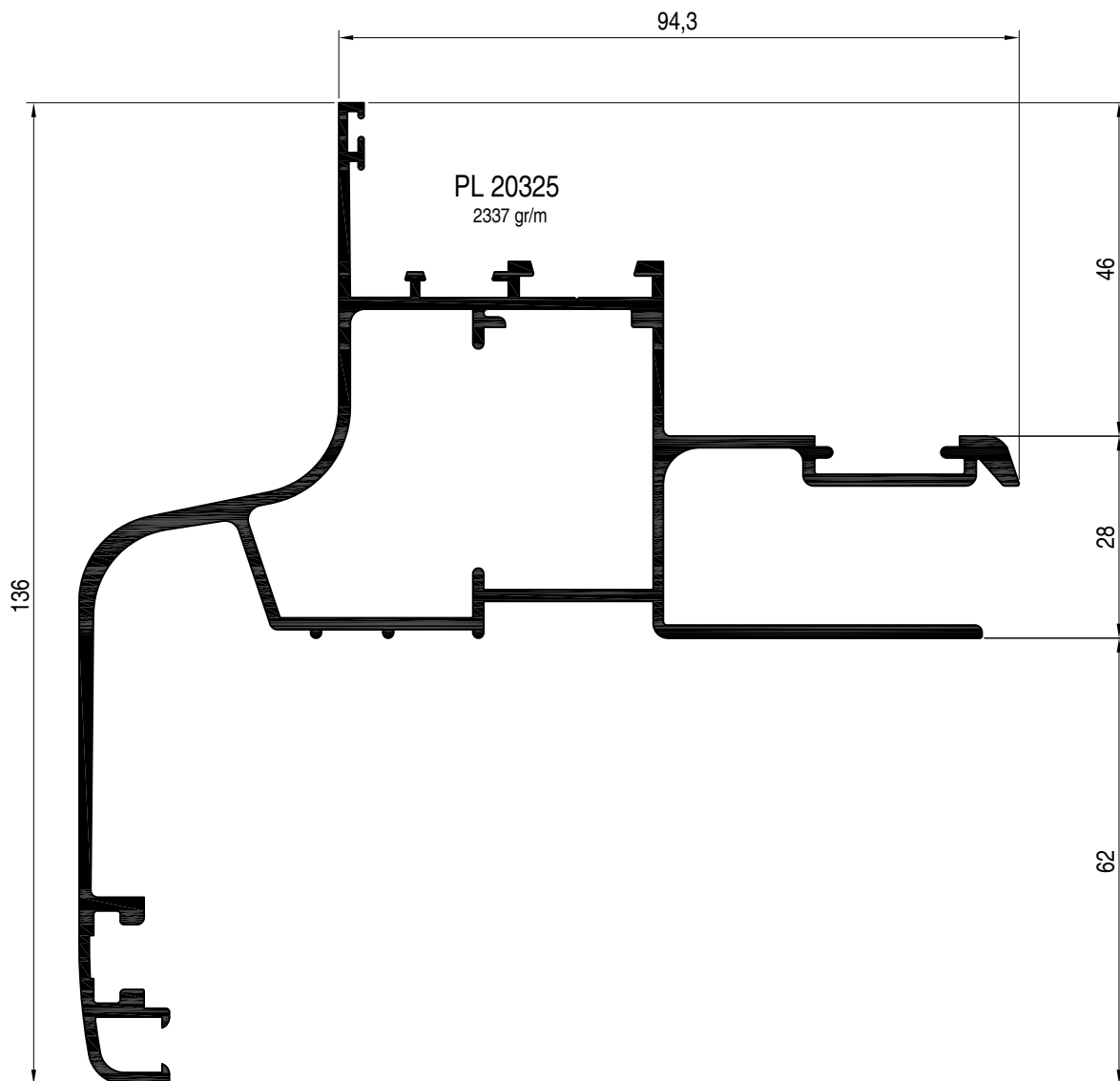

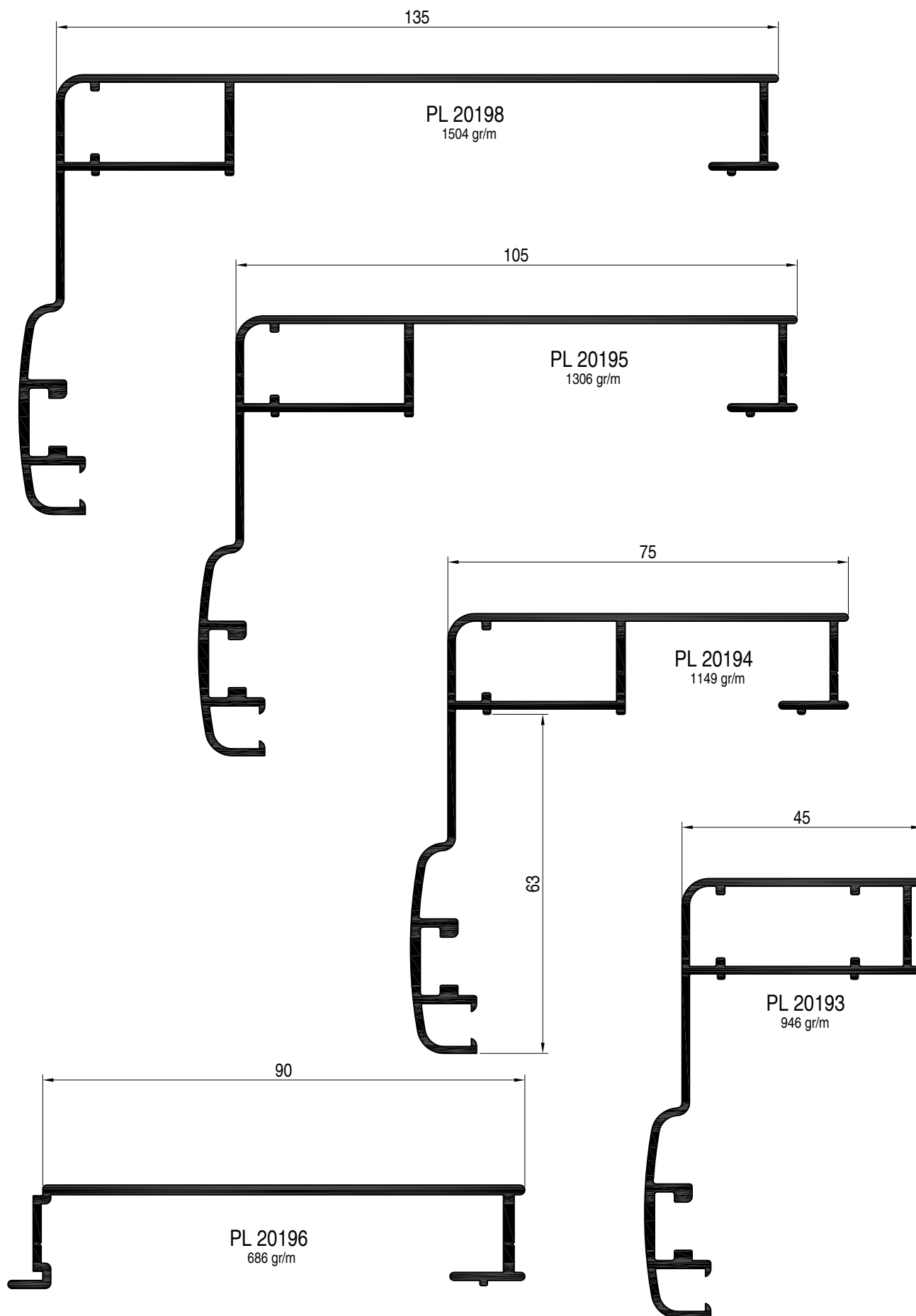

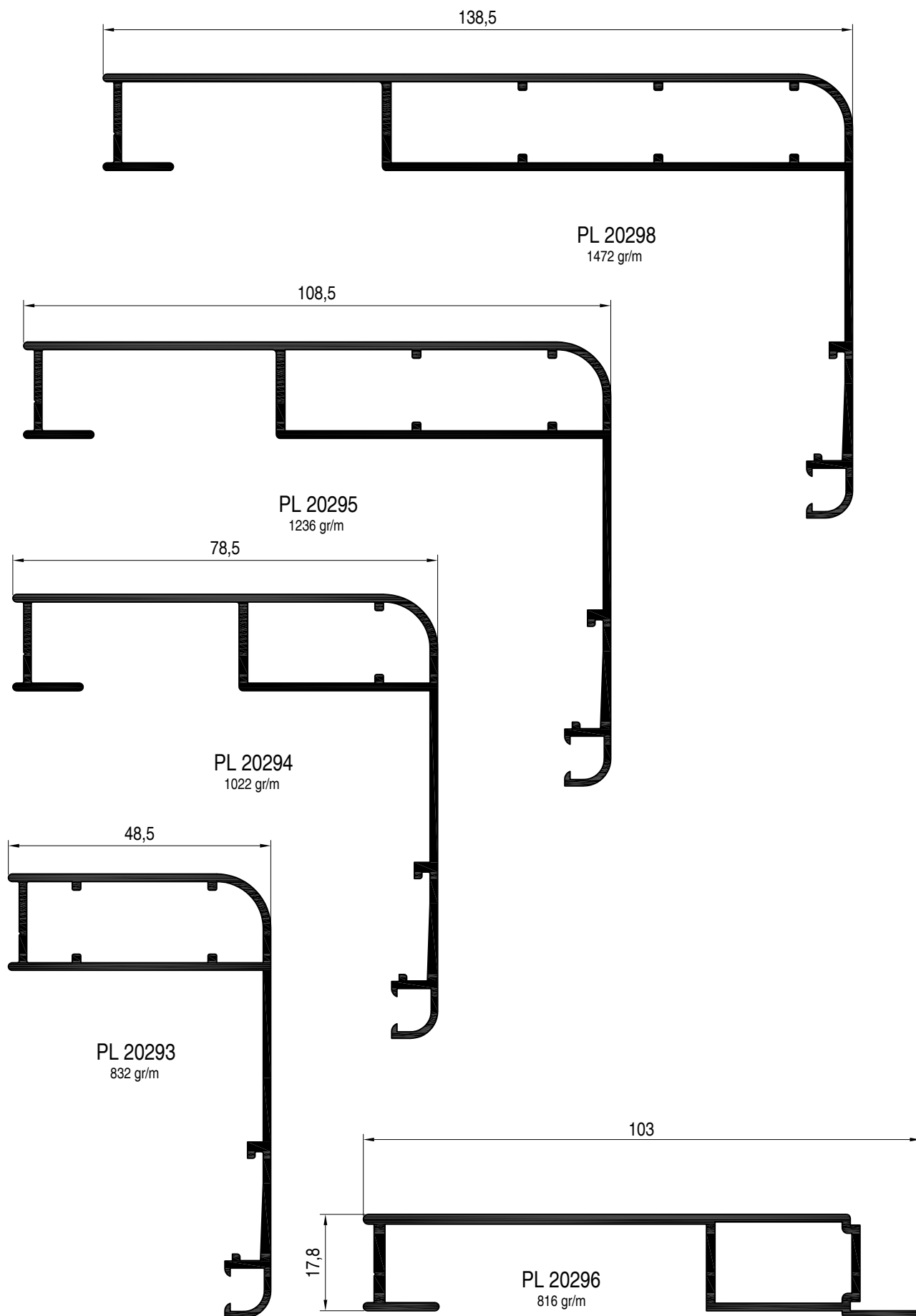

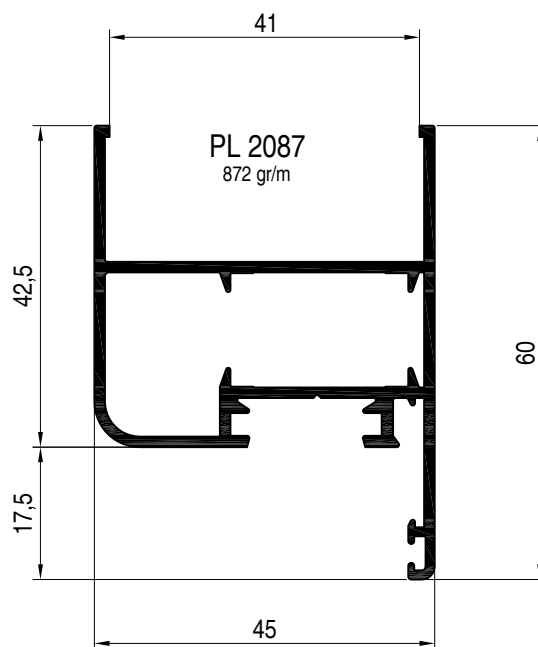
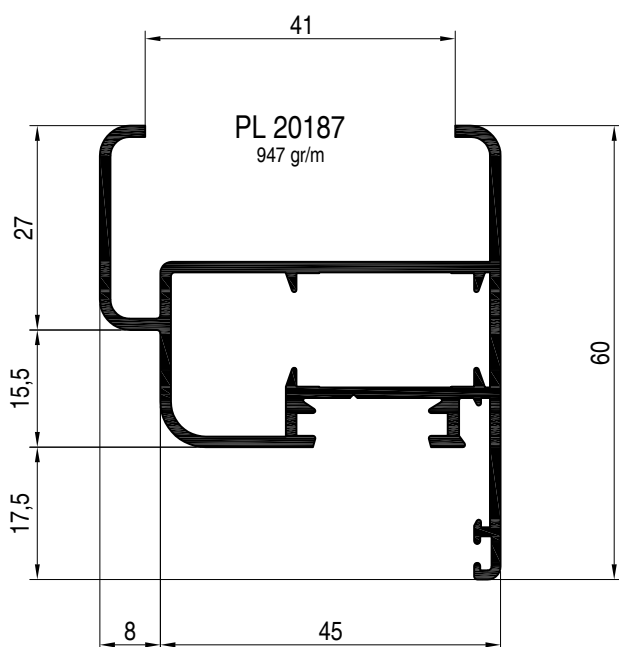
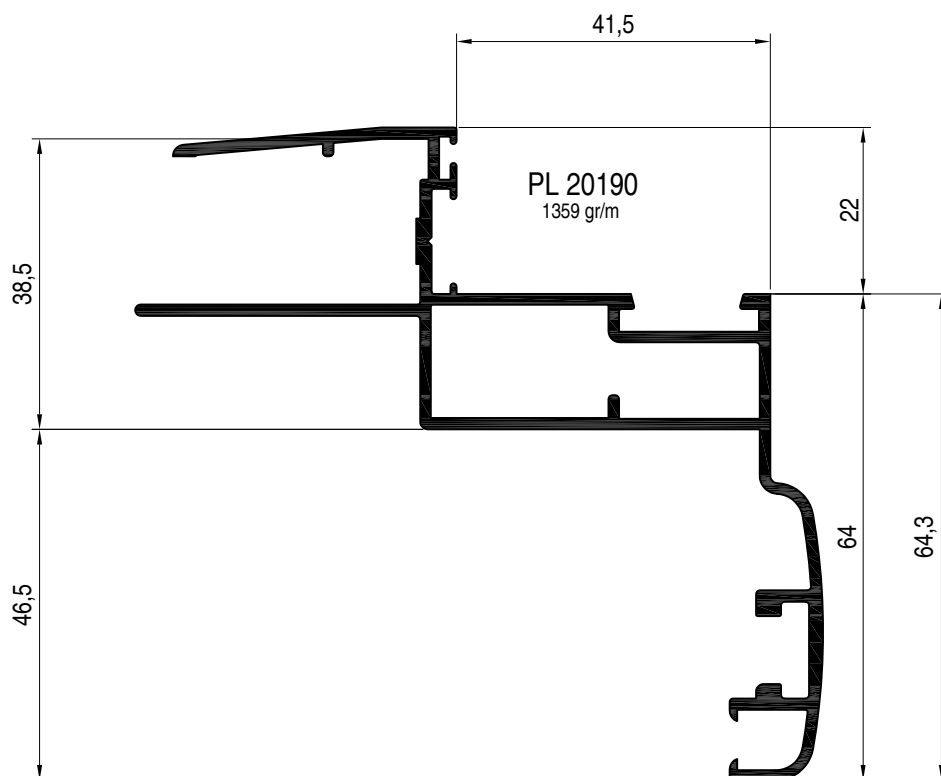

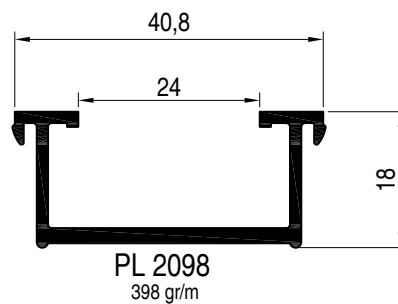
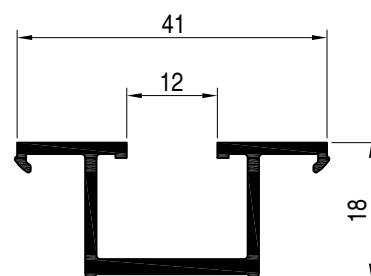
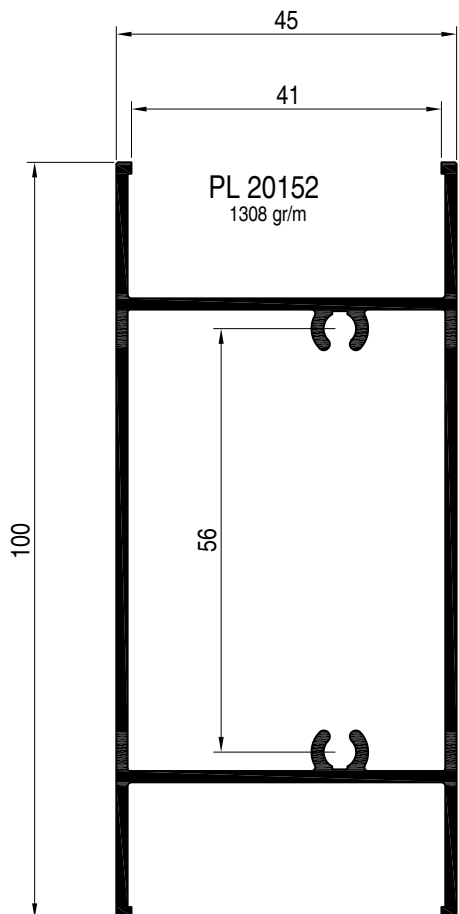
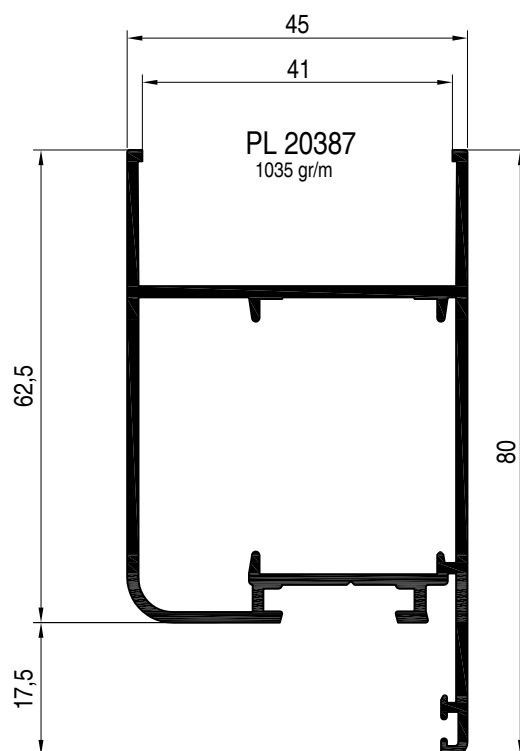
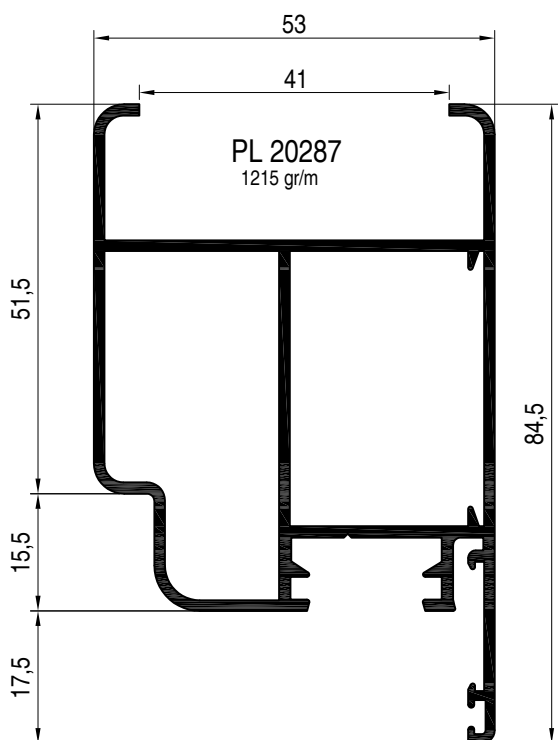

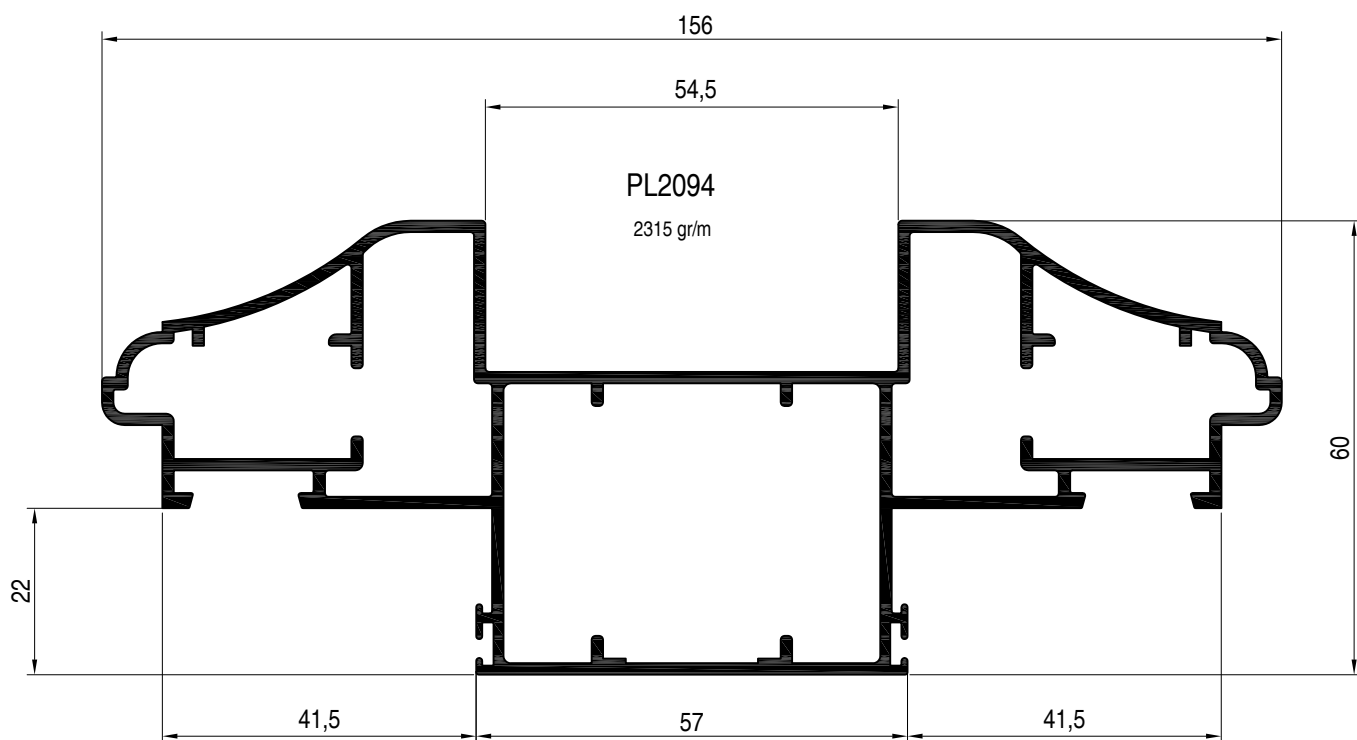
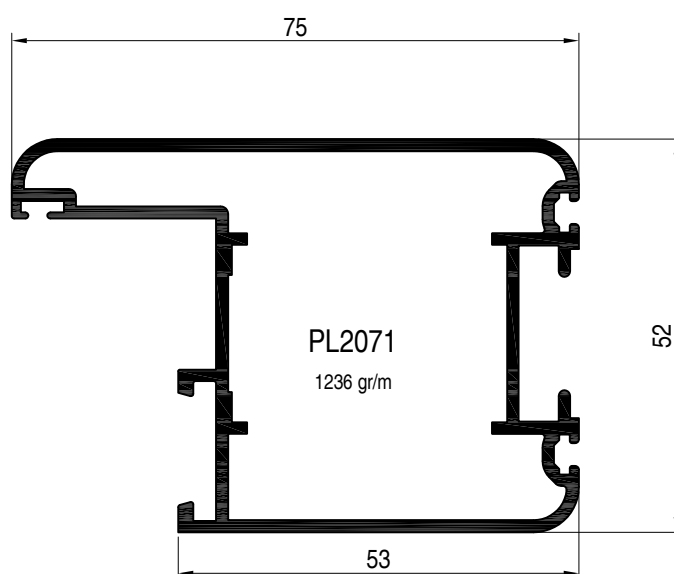
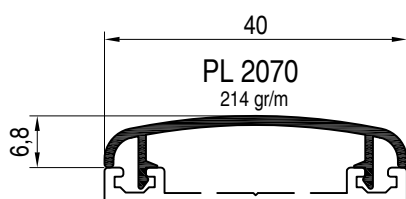
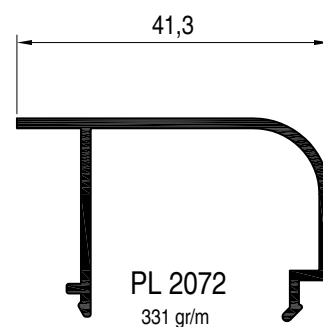
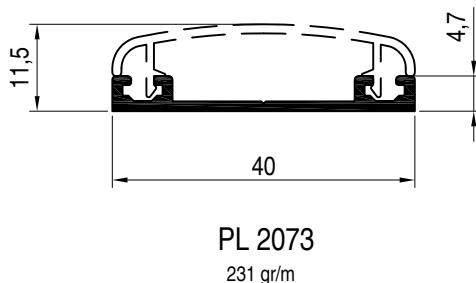
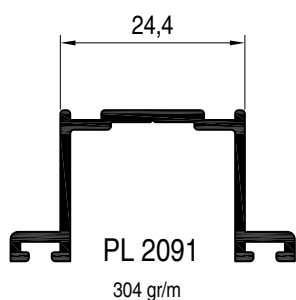

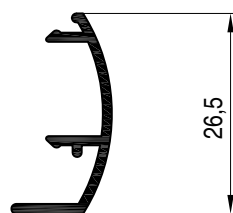
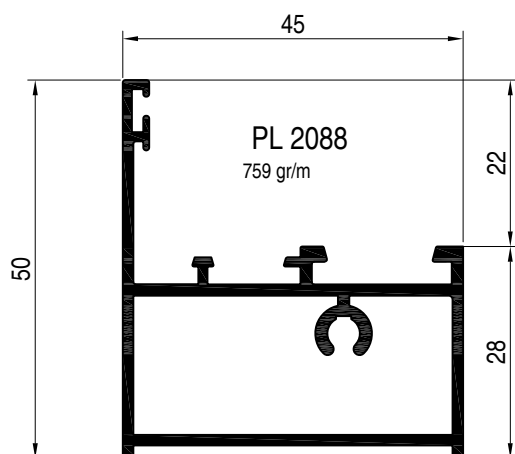
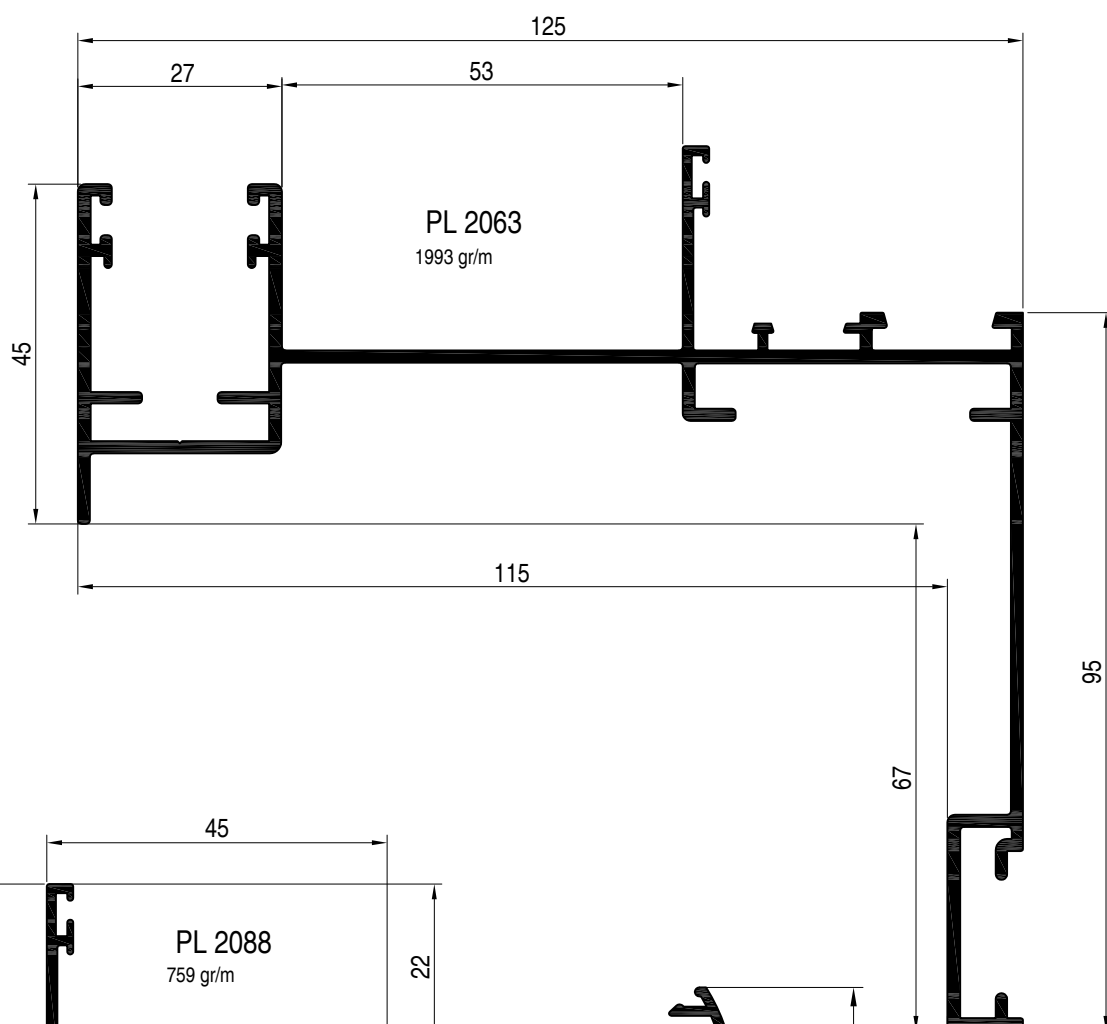
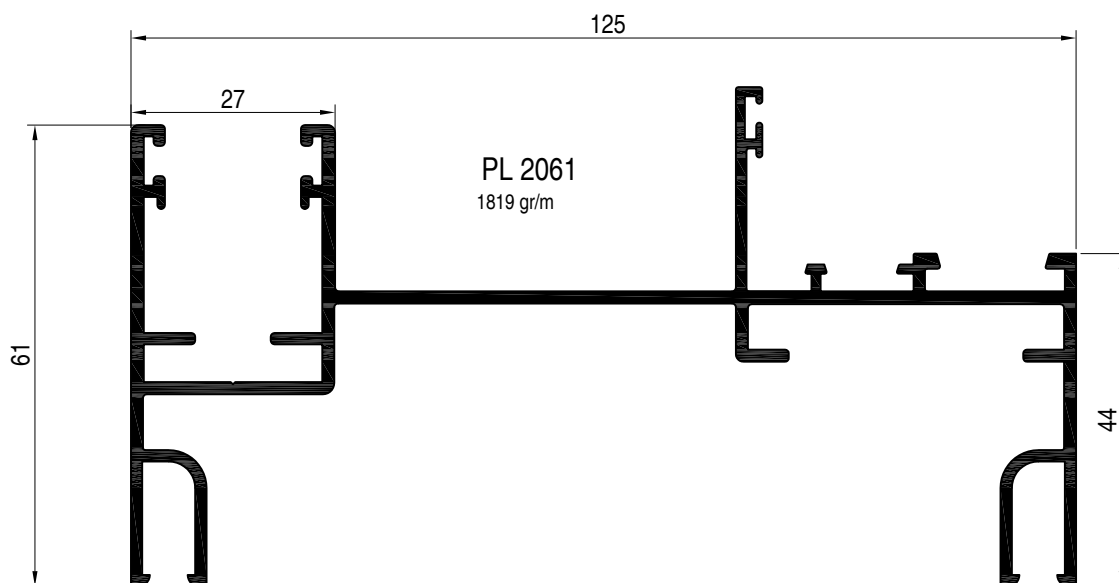

AS 48167
160 gr/m

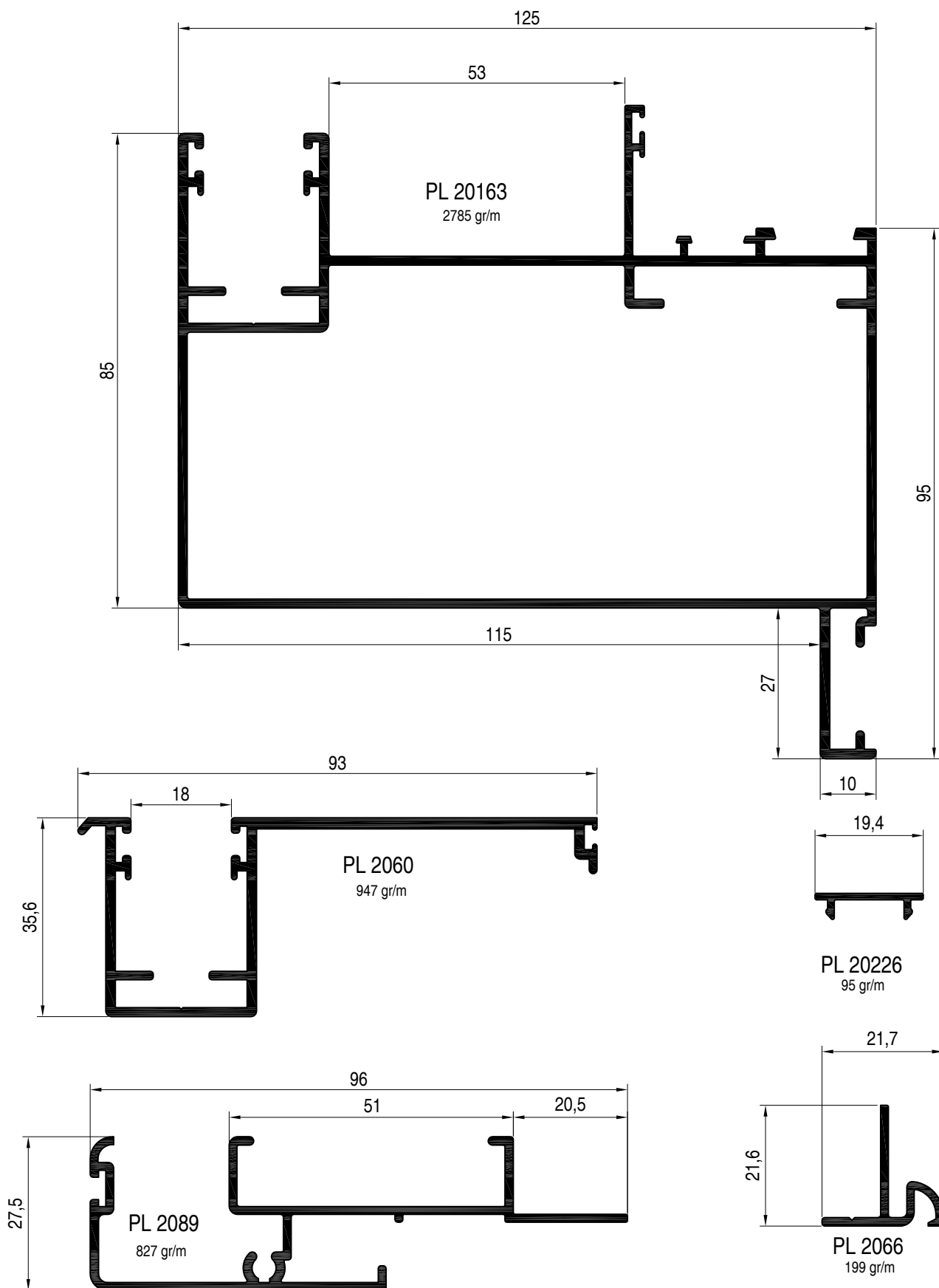

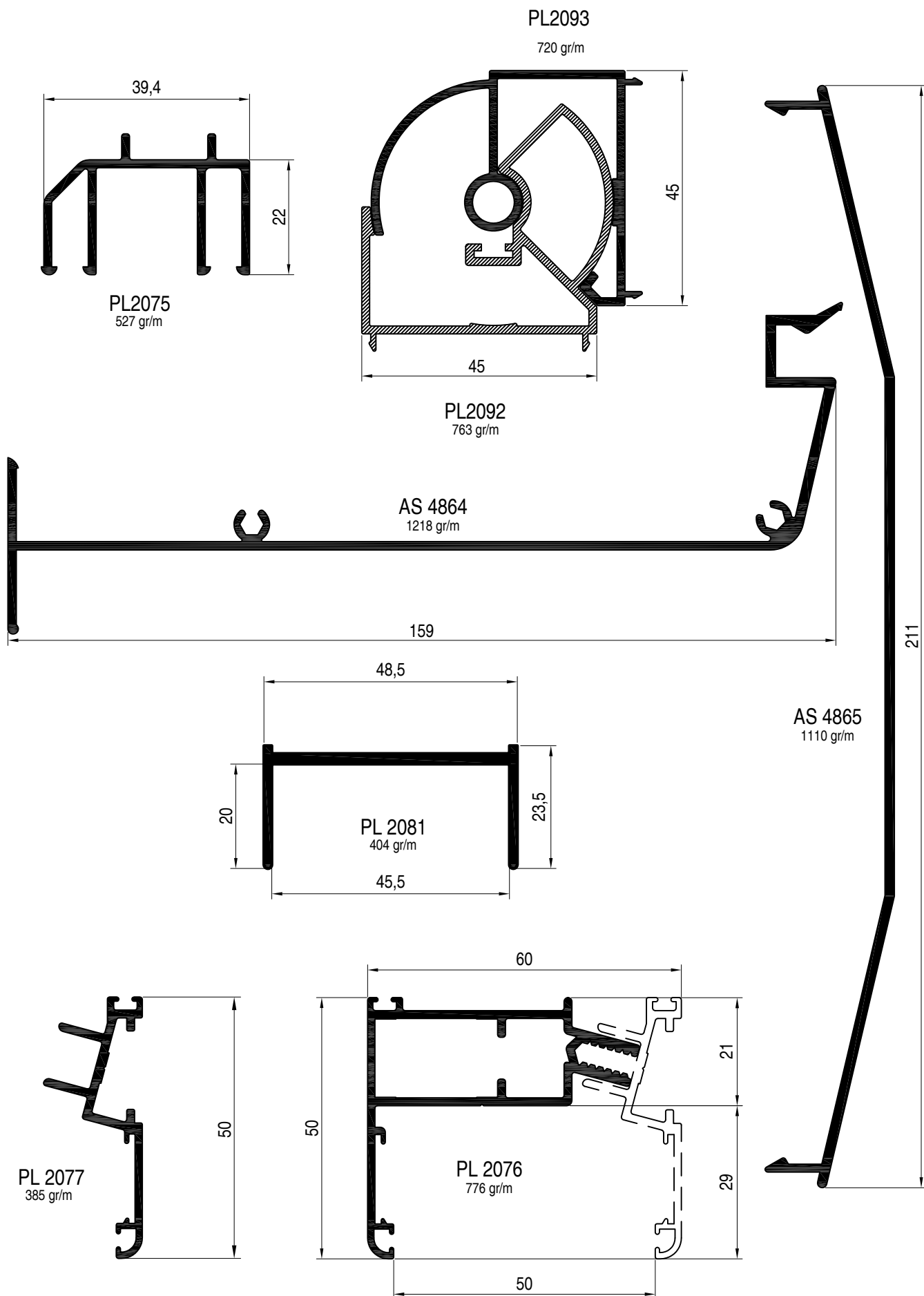

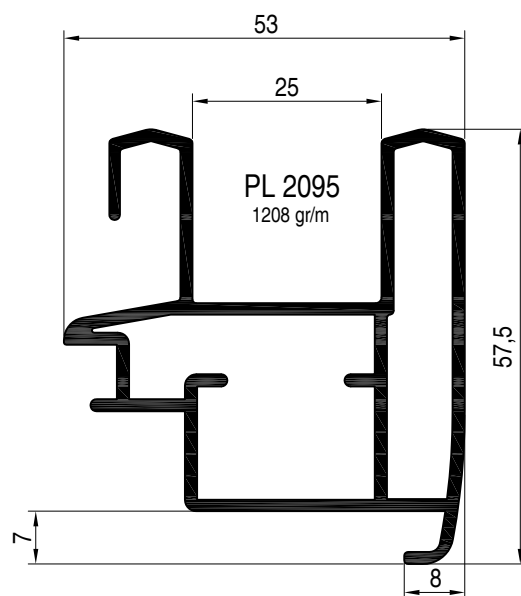
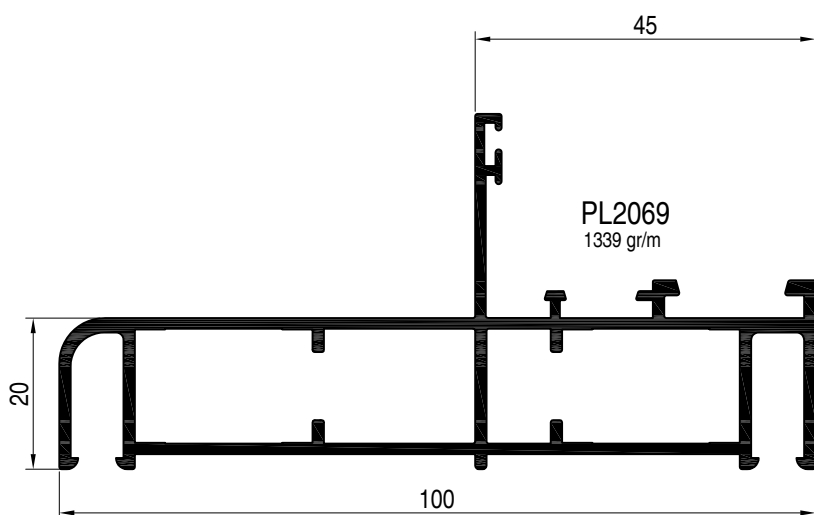
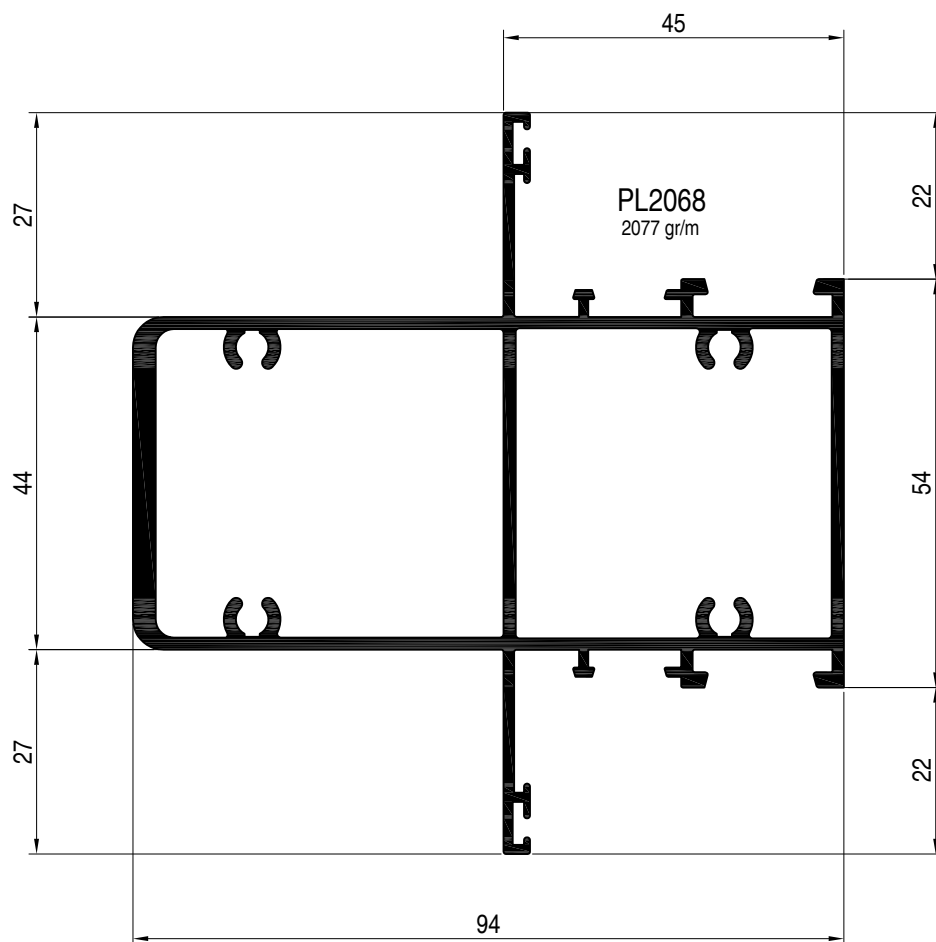

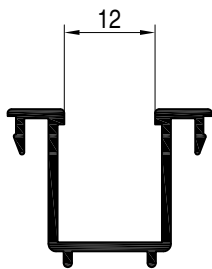

PL 6097
246 gr/m

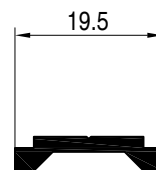

AS 1000
119 gr/m

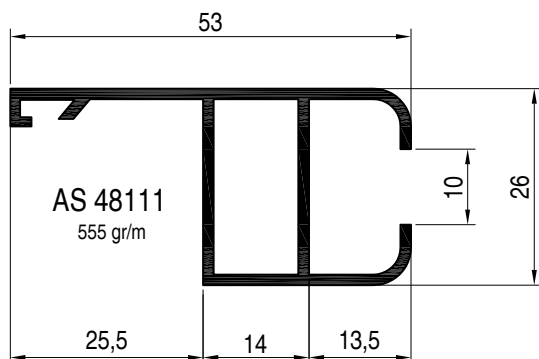

AS 48111
555 gr/m

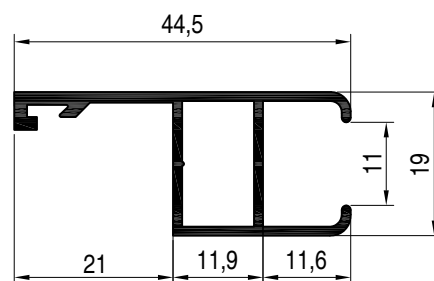

ET00633
390 gr/m

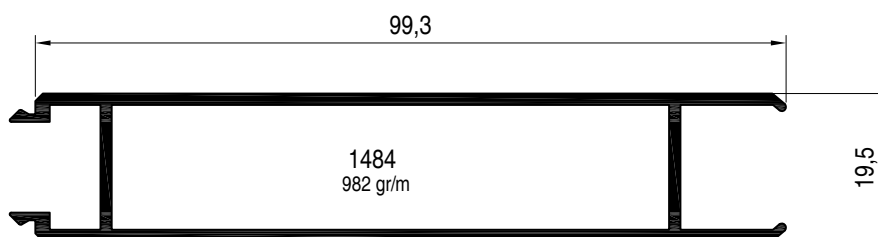

1484
982 gr/m

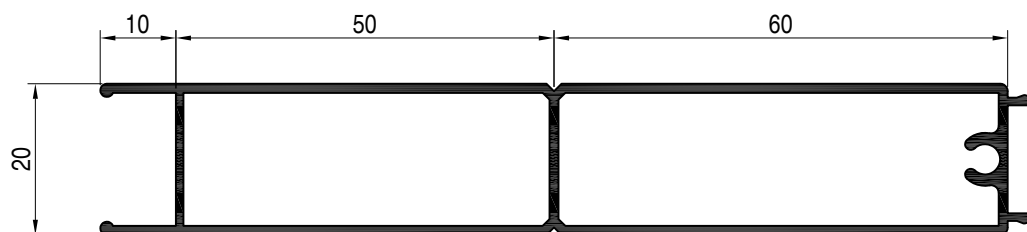

R 3521
1001gr/m

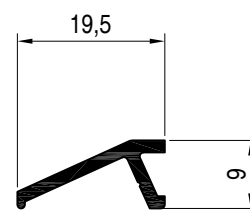
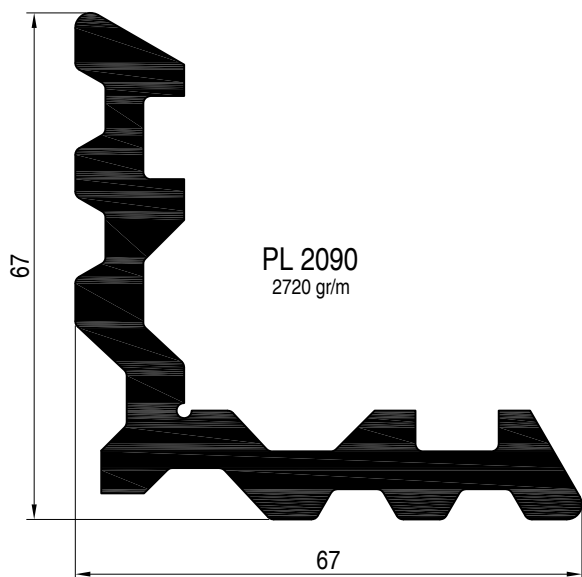

PL 20100
129 gr/m

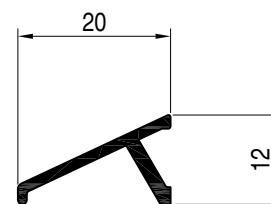

AS 1001R
127 gr/m

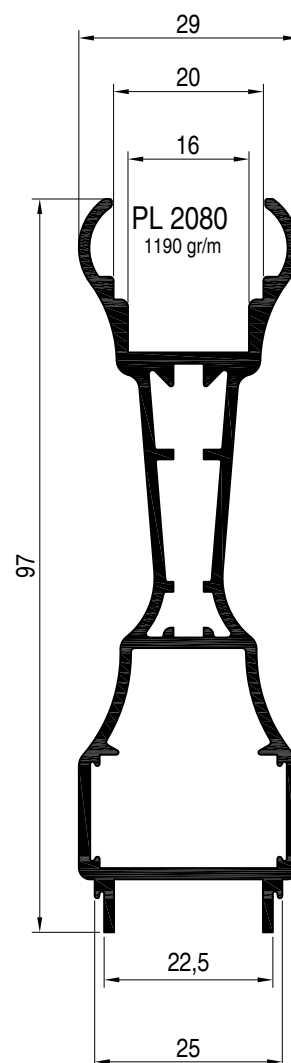
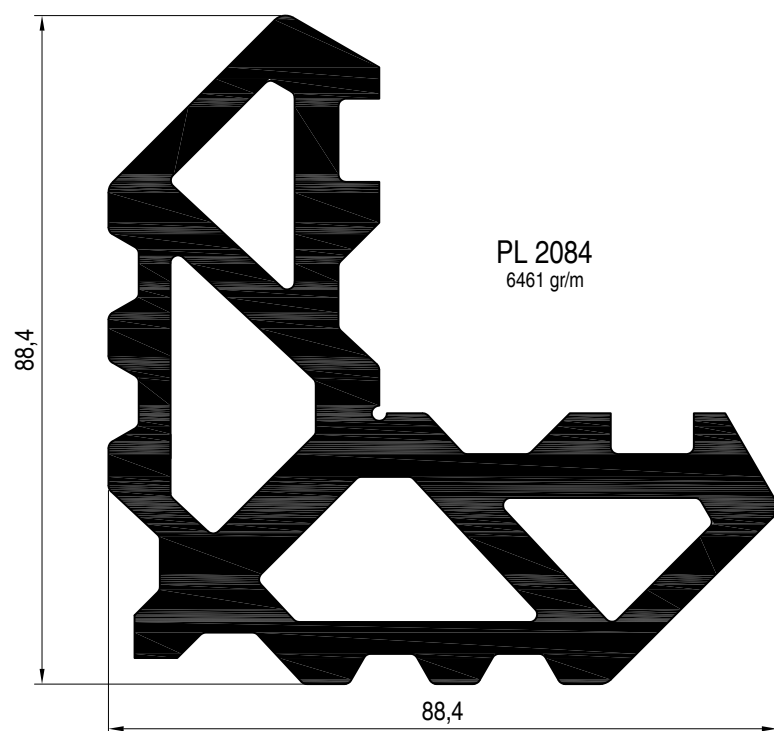

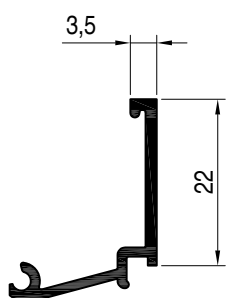

PL 1404
190 gr/m

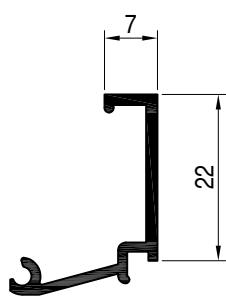

PL 1407
206 gr/m

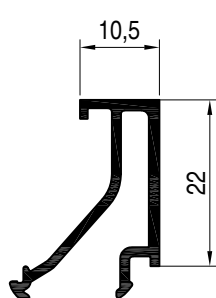

PL 1411
252 gr/m

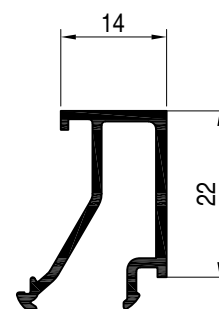

PL 1414
257 gr/m

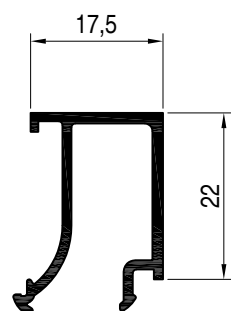

PL 1418
268 gr/m

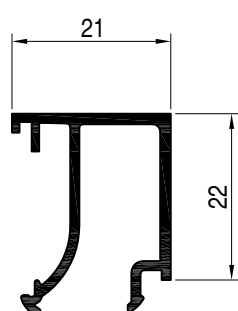

PL 1421
290 gr/m

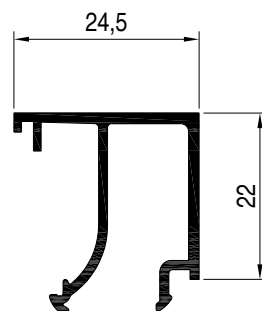

PL 1425
304 gr/m

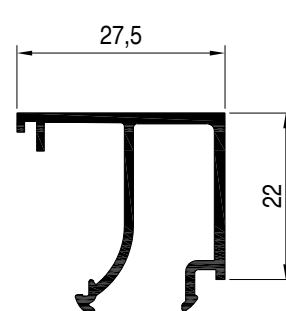

PL 1428
312 gr/m

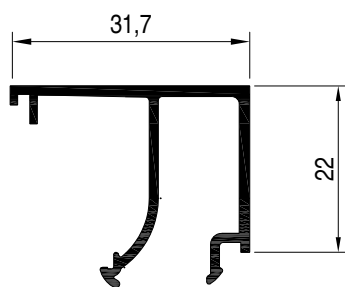

PL 1432
331 gr/m

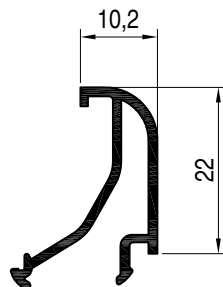

PL 1511
238 gr/m

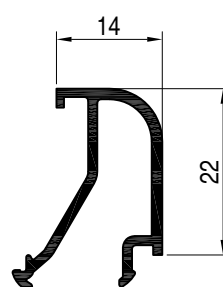

PL 1514
247 gr/m

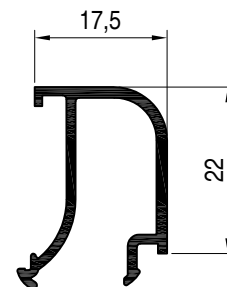

PL 1518
257 gr/m

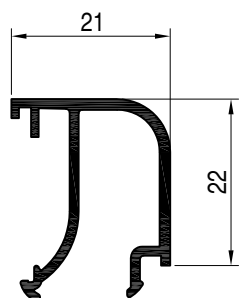

PL 1521
279 gr/m

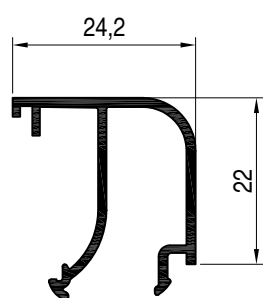

PL 1525
290 gr/m

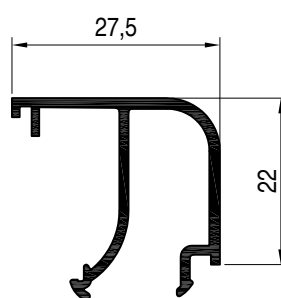

PL 1528
301 gr/m

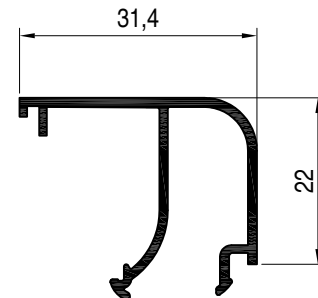

PL 1532
317 gr/m

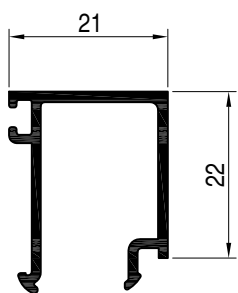

PL 14121
280 gr/m

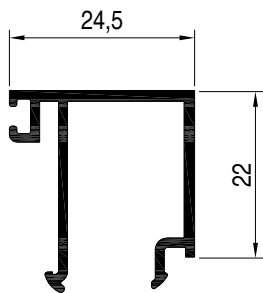

PL 14125
313 gr/m

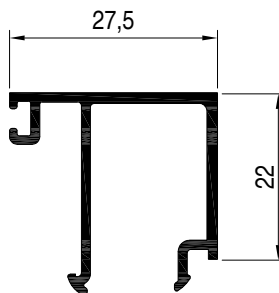

PL 14128
323 gr/m

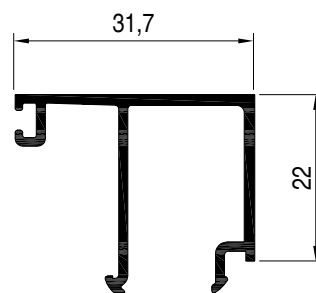

PL 14132
338 gr/m

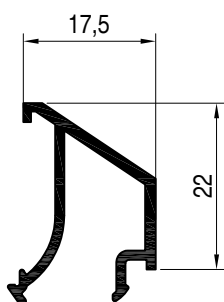

PL 1818
236 gr/m

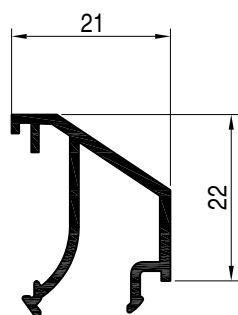

PL 1821
258 gr/m

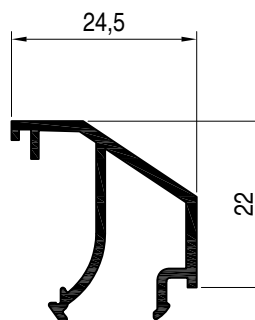

PL 1825
270 gr/m

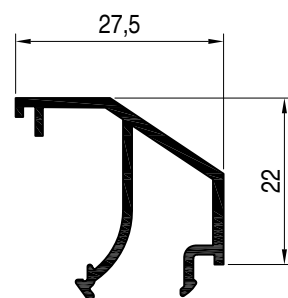

PL 1828
279 gr/m

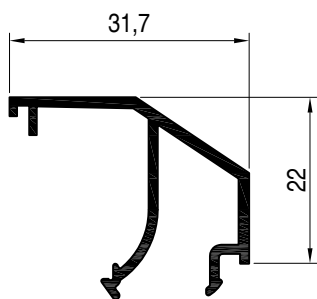

PL 1832
296 gr/m

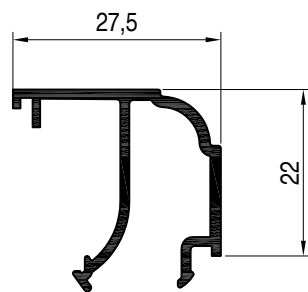

PL 1928
298 gr/m

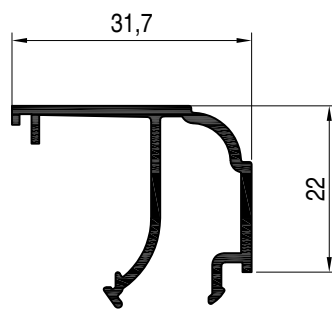



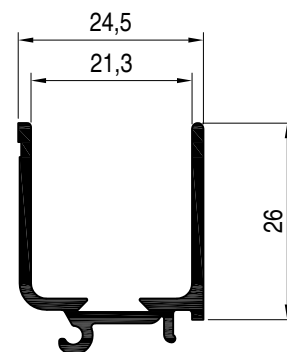







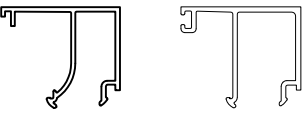
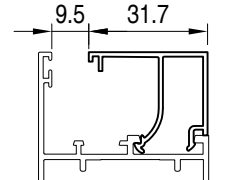
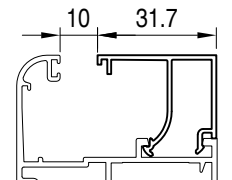
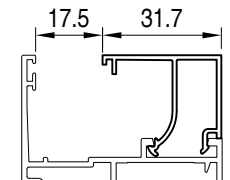

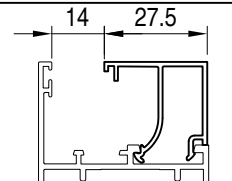
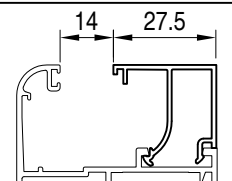
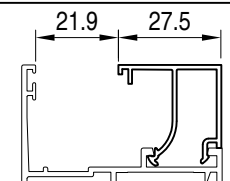
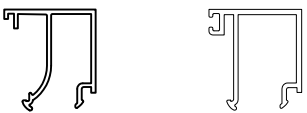
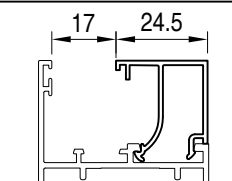
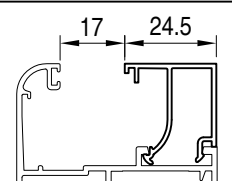
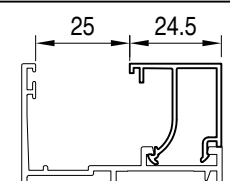
PL 1932
317 gr/m

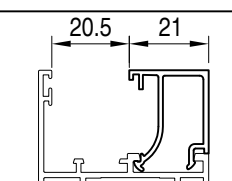
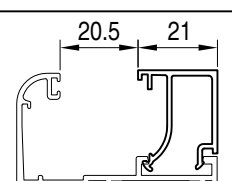
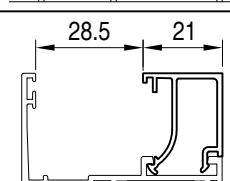

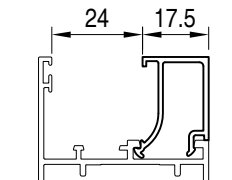
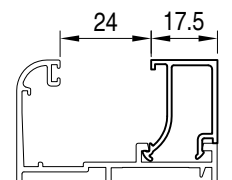
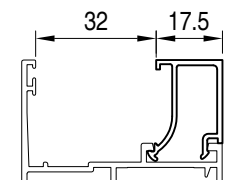

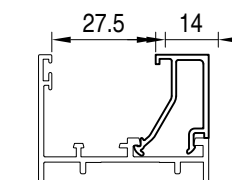
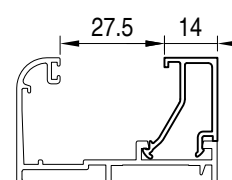
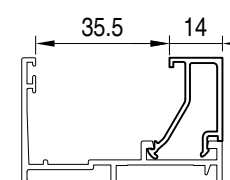
PL 1325 *
348 gr/m

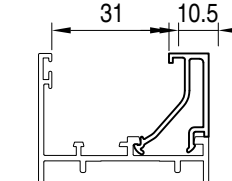
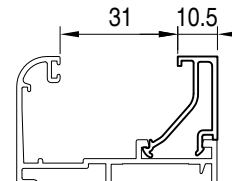
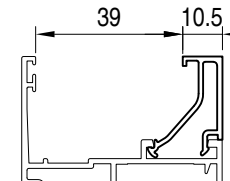
*
UTILIZZARE SEMPRE GOMMINO ACP5027

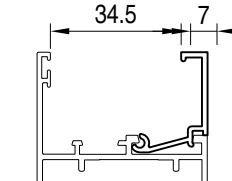
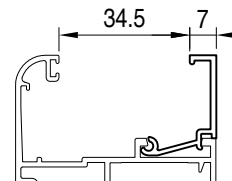
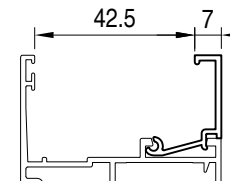
vetrazione

fermavetro	telaio PL 2002 e simili	anta PL 2012 e simili	anta PL 2011 e simili
 PL 1432 PL 14132			
 PL 1428 PL 14128			
 PL 1425 PL 14125			
 PL 1421 PL 14121			
 PL 1418			
 PL 1414			
 PL 1411			
 PL 1407			

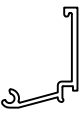
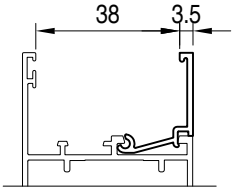
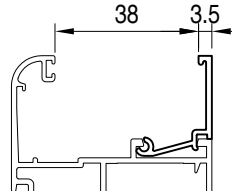
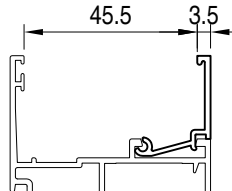
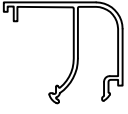
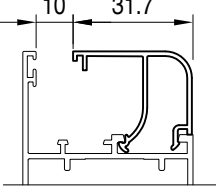
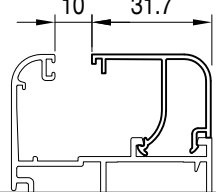
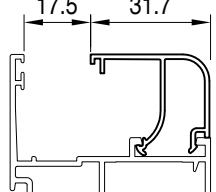
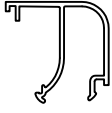
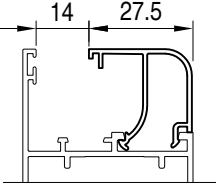
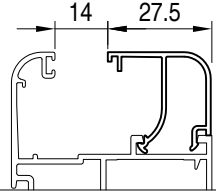
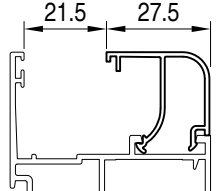
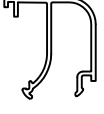
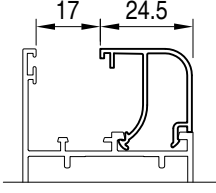
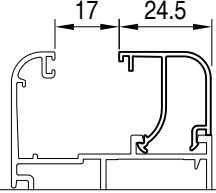
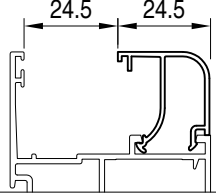
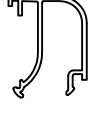
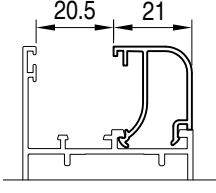
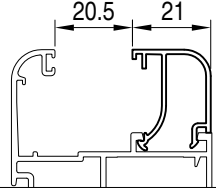
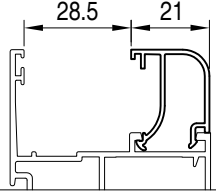
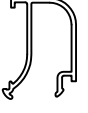
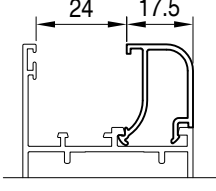
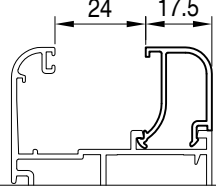
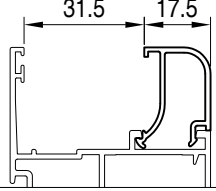
vetrazione

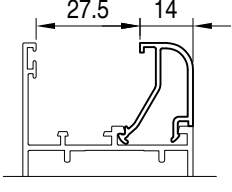
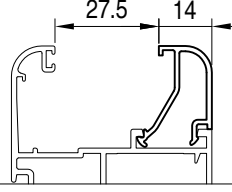
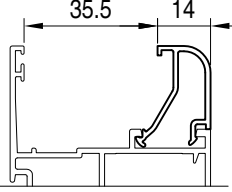
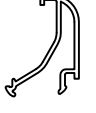
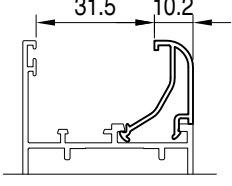
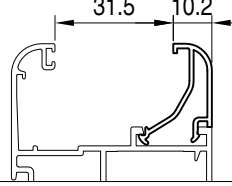
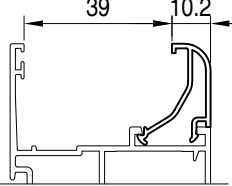
fermavetro	telaio PL 2002 e simili	anta PL 2012 e simili	anta PL 2011 e simili
 PL 1404	 38 3.5	 38 3.5	 45.5 3.5
 PL 1532	 10 31.7	 10 31.7	 17.5 31.7
 PL 1528	 14 27.5	 14 27.5	 21.5 27.5
 PL 1525	 17 24.5	 17 24.5	 24.5 24.5
 PL 1521	 20.5 21	 20.5 21	 28.5 21
 PL 1518	 24 17.5	 24 17.5	 31.5 17.5
 PL 1514	 27.5 14	 27.5 14	 35.5 14
 PL 1511	 31.5 10.2	 31.5 10.2	 39 10.2

vetrazione

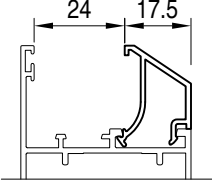
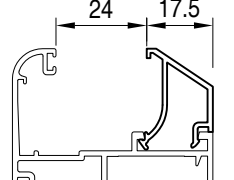
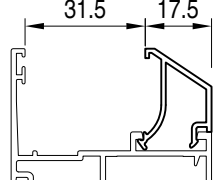
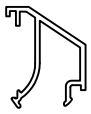
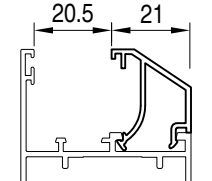
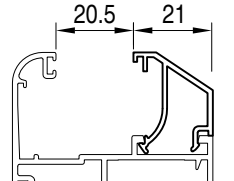
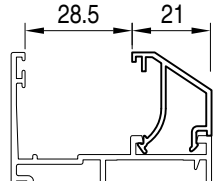
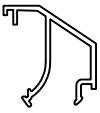
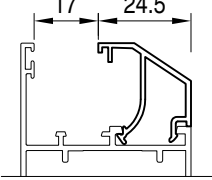
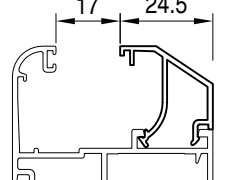
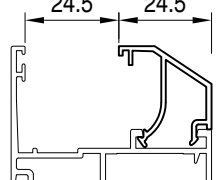
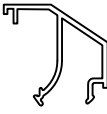
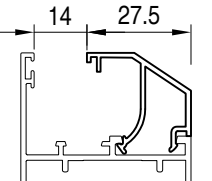
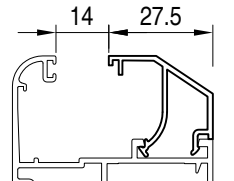
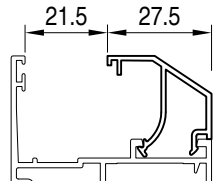
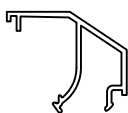
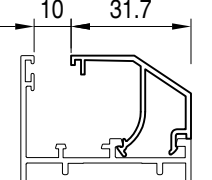
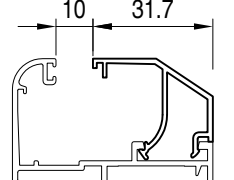
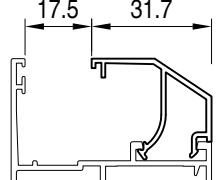
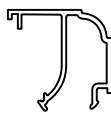
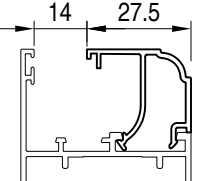
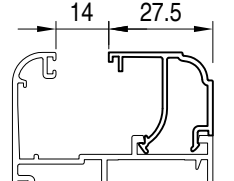
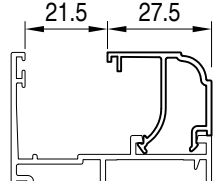
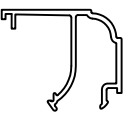
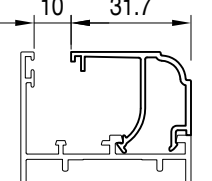
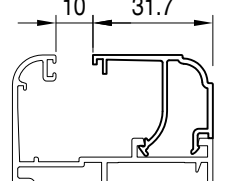
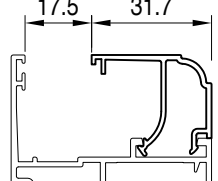
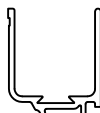
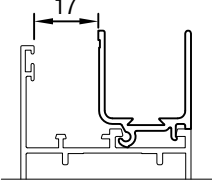
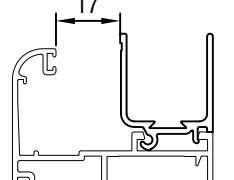
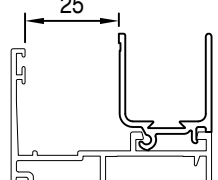
fermavetro	telaio PL 2002 e simili	anta PL 2012 e simili	anta PL 2011 e simili
 <p>PL 1818</p>			
 <p>PL 1821</p>			
 <p>PL 1825</p>			
 <p>PL 1828</p>			
 <p>PL 1832</p>			
 <p>PL 1928</p>			
 <p>PL 1932</p>			
 <p>PL 1325</p>			

Indice alfanumerico accessori/guarnizioni

AC 2001	Vite trilobata per cavallotto ACP 50420
AC 2028	Tappo scarico acqua
AC 2068	Maniglia tavellino piccola
AC 2069	Cerniera scuretto
AC 2077	kit registrazione vetro per ante vetro ad infilare
AC 2099	Tappino chiudiforo \varnothing 11.5mm
AC 5000	Spina \varnothing 8mm per cavallotto ACP 50420
ACP 5001	Vite \varnothing 8 per squadretta multifunzione ACP 5801, ACP 5802, ACP 7001
ACP 50010	Avvolgitore senza placca
ACP 50011	Placca per avvolgitore
ACP 5002	Squadretta 23x14 mm a pulsante \varnothing 10 mm - filettata
ACP 5005	Cerniera componenti inox e piastrini premontati, per telai piani, usare 1 coppia $h_{max}=1800$ mm per h oltre 1800 mm inserire la 3 ^a cerniera
ACP 5005D	Cerniera premontata destra, per telai piani, usare 1 coppia $h_{max}=1800$ mm per h oltre 1800 mm inserire la 3 ^a cerniera
ACP 5005S	Cerniera premontata sinistra, per telai piani, usare 1 coppia $h_{max}=1800$ mm per h oltre 1800 mm inserire la 3 ^a cerniera
ACP 5006	Cerniera 3 ali componenti inox e piastrini premontati, per telai piani
ACP 5007	Cerniera 3 ^a anta componenti inox e piastrini premontati, usare 1 coppia $h_{max}=1800$ mm per h oltre 1800 mm inserire la 3 ^a cerniera
ACP 5007D	Cerniera 3 ^a anta premontata destra, usare 1 coppia $h_{max}=1800$ mm per h oltre 1800 mm inserire la 3 ^a cerniera
ACP 5007S	Cerniera 3 ^a anta premontata sinistra, usare 1 coppia $h_{max}=1800$ mm per h oltre 1800 mm inserire la 3 ^a cerniera
ACP 5008	Squadretta allineamento in acciaio inox
ACP 50095	Guida cinghia a cassonetto
ACP 5010	Cerniera vasistas doppio scatto
ACP 50100	Cremonese bidirezionale Giada

ACP 50101	Piastrino anti rollio per cremonese ACP 50100
ACP 50104	Cremonese apertura esterna
ACP 50105	kit apertura esterna di collegamento per ACP 50104
ACP 50106	Perno 16 mm di trascinamento asta cremonese per ACP 50105
ACP 50107	Basetta in nylon sagomata per cremonese Giada
ACP 50109	Movimento asta a leva anta affiancata
ACP 5011	Bracci sporgere telescopici
ACP 50110	Squadretta allineamento con eccentrici di tiraggio
ACP 50111	Kit angoli di rinvio x movimento asta a leva anta affiancata
ACP 50117D	Mensola destra per supporto a squadra ACP 50220
ACP 50117S	Mensola sinistra per supporto a squadra ACP 50220
ACP 50118	Nastro magnetico in acciaio per Easysun
ACP 5012	Cerniera vasistas scatto singolo
ACP 50120D	Mensola destra per supporto verticale ACP 50320
ACP 50120S	Mensola sinistra per supporto verticale ACP 50320
ACP 5013	Cricchetto vasistas
ACP 5014	Angolino per fermavetri maggiorati PL 1521, PL 1525, PL 1528, PL 1532
ACP 50150	Kit anta ribalta con cerniere e cremonese, per telai piani (Complanare esterno Sormonto interno)
ACP 50151	Kit anta ribalta con cerniere e cremonese, per telai complanari (Complanare esterno, Complanare interno)
ACP 50152	Martellina 90-180° quadro 7 mm
ACP 5016	Braccio sganciabile inox
ACP 50160/1100	Kit binari per scorrevole parallelo L anta = da 851 mm a 1100 mm
ACP 50160/1350	Kit binari per scorrevole parallelo L anta = da 1101 mm a 1350 mm

ACP 50160/1600	Kit binari per scorrevole parallelo L anta = da 1351 mm a 1600 mm
ACP 50161/1200	Kit forbici scorrevole parallelo soluzione manuale per ante fino a 1200 mm, abbinare ad ACP 50165
ACP 50162	Kit forbici scorrevole parallelo soluzione automatica per ante fino a 2000 mm fino a 1600 mm di anta utilizzare ACP 50159, da 1600 a 2000 mm occorrono carrelli con portata 180 Kg KIT DISPONIBILE SU RICHIESTA ABBINARE ALLA MANIGLIA ACP 50170
ACP 50163	Kit accessori per trasformare il kit manuale ACP 50161 in semiautomatico per profili a camera europea da abbinare ad ACP 50166
ACP 50164	Kit copertura disponibile nelle colorazioni argento, RAL 9010 e nero elettro-colore
ACP 50165	Spessori per forbici da abbinare con ACP50161/1200 o ACP 50162. Disponibile nelle colorazioni argento e nero elettro-colore
ACP 50166	Placchetta di fermo - per trasformare il kit forbici manuale in semiautomatico da abbinare ad ACP 50163
ACP 50167	Kit supplementare per ante oltre i 1200 mm da abbinare alle astine ACP 50168 e ACP 50169
ACP 50168	Astina per kit supplementare per ante da 1201 mm fino a 1350 mm
ACP 50169	Astina per kit supplementare per ante da 1351 mm fino a 1600 mm
ACP 5017	Cricchetto vasistas applicazione rapida
ACP 50170	Maniglia quadro 10 mm per kit automatico scorrevole parallelo ACP 50162. Disponibile nei colori argento e nero RAL 9010
ACP 5019	Riscontro 3a chiusura
ACP 5021	Kit 3a chiusura registrabile
ACP 5022	Catenacciolo
ACP 50220	Supporto a squadra 46x10 rullo tapparella
ACP 5023	Tappo anti intestatura per profili vetro infilare spazio 25 mm
ACP 5024	Incontro asta doppio in zama
ACP 5025	Terminale asta
ACP 5026	Piastra sostegno anta
ACP 5027	Gommino blocca fermavetro per PL 1325
ACP 5032	Manico per cremonese

ACP 50320	Supporto verticale 40x5 rullo tapparella
ACP 5033	Cremonese senza manico
ACP 5034	Cremonese con chiave
ACP 5035	Regolo a muro in nylon
ACP 5036	Regolo a muro in metallo
ACP 5037	Cremonese monodirezionale con impugnatura lunga per anta ribalta e scorrevole parallelo.
ACP 5039	Doppia maniglia per porte
ACP 50420	Cavallotto 23x14 mm a scatto in estruso
ACP 5043	Kit cerniere per anta abbinata telai piani (Complanare esterno Sormonto interno)
ACP 5044	Kit cerniere per anta abbinata telai modanati (Complanare esterno Complanare interno)
ACP 5045	Blocchetti collegamento cremonese in zama
ACP 50454	Cavallotto a scatto in estruso per PL 2038
ACP 5046/350	Braccio ribalta 345/410 mm
ACP 5046/411	Braccio ribalta 411/540 mm
ACP 5046/541	Braccio ribalta 541/1500 mm
ACP 5047	Kit chiusura anta abbinata
ACP 5049	Braccio supplementare
ACP 5052	Kit catenaccioli in alluminio con eccentrico di registrazione per anta semifissa
ACP 5053	Giunzione astina per prolunga catenaccioli ACP 5052
ACP 5056	Kit chiusura supplementare orizzontale
ACP 5057	Kit chiusura supplementare verticale
ACP 5058	Rotella infila guarnizioni
ACP 5069	Cerniera 3 ali 3 ^a anta componenti inox e piastrini premontati,

ACP 50704	Cassetta semi incasso
ACP 50705	Avvolgitore con placca nera per cinghia tapparella
ACP 5076	Maniglia a tavellino
ACP 5079	Tappo riporto centrale Planet 45 versione giunto aperto
ACP 5081	Incontro asta singolo in nylon
ACP 5082	Incontro asta doppio in nylon
ACP 50825	Puleggia da 180 mm
ACP 5083	Tappo riporto centrale Planet 45 versione doppia battuta
ACP 50832	Calotta di supporto per rullo
ACP 5084	Squadretta allineamento con vite di tiraggio per telai e imbotti
ACP 5085	Kit anta ribalta fulcro orizzontale
ACP 5086	Kit chiusura 4 punti bilico verticale
ACP 5088	Kit chiusura 4 punti bilico orizzontale
ACP 5090	Frizione bilico senza fermo, portata 75 Kg
ACP 5091	Frizione bilico con fermo, portata 75 Kg
ACP 5093	Tappi cassonetto
ACP 5095	Inviti guida tapparella
ACP 5099	Regolo a muro rialzato per telai con camera intermedia
ACP 51001	Guida cinghia da montante
ACP 51190	Boccola di giunzione rullo/puleggia rullo/calotta
ACP 51520	Vite di fissaggio supporto/mensola
ACP 5501	Squadretta maggiorata 23x35 mm a pulsante ø10 mm
ACP 5504	Squadretta 23x14 mm angolo variabile min.30° max 178°







ACP 5506	Squadretta maggiorata 23x35 mm angolo variabile min. Angolo 55° max 315°
ACP 5521	Cavallotto 23x14 mm in pressofuso a pulsante
ACP 5800	Spina per squadretta multifunzione ACP 5801, ACP 5802 , ACP 7001
ACP 5801	Squadretta 23x14 mm multifunzione, avvitare, spinare o cianfrinare abbinare con ACP 5800 per spinare e ACP 5001 per avvitare
ACP 5802	Squadretta maggiorata 23x35 mm multifunzione, avvitare, spinare o cianfrinare. Abbinare con ACP 5800 per spinare e ACP 5001 per avvitare
ACP 5805	Squadretta 23x14 mm angolo variabile strong min.60° max 120°
ACP 5821	Cavallotto 23x14 mm in pressofuso con grano e codulo
ACP 9909	Spessore 8 mm per cerniere ad applicazione frontale
ACP 99124	Cover per cerniera ACP 9918 e ACP 9938
ACP 99125	Piastrino universale di registrazione verticale delle ante per le cerniere strong ACP 9918 e ACP 9938
ACP 99126	Chiave per montaggio cerniera ACP 9918 e ACP 9938
ACP 9915	Spessore 7 mm per cerniere ad applicazione frontale
ACP 9918	Cerniera Strong a 2 ali per telai filiformi (complanare Esterno sormonto Interno) vedere schede di montaggio
ACP 9938	Cerniera Strong 2 ali, 3° anta anche per telai filiformi (complanare Esterno complanare Interno) vedere schede di montaggio
ACP 9963/60	Cerniera frontale, 3 ali int. 60 mm
ACP 9963/93	Cerniera frontale, 3 ali int. 93 mm
ACP 9964/60	Cerniera frontale 2 ali int. 60 mm
ACP 9964/93	Cerniera frontale 2 ali int. 93 mm
ACP 9973	Kit fissaggio cerniere applicazione frontale 2 ali
ACP 9974	Kit fissaggio cerniere applicazione frontale 3 ali
ACP 9998	Dima di foratura per cerniere applicazione frontale
AGG 3000	Guarnizione di battuta per telai capannoni e imbotti porte interne
AGG 3092	Giunto per finestrate a nastro







AGP 3002	Guarnizione vetro interna in EPDM 2 mm
AGP 3003	Guarnizione vetro interna in EPDM 3 mm
AGP 3005	Guarnizione vetro interna in EPDM 5 mm
AGP 3101	Guarnizione vetro interna in PVC 1 mm
AGP 3102	Guarnizione vetro interna in PVC 2 mm
AGP 3103	Guarnizione vetro interna in PVC 3 mm
AGP 3104	Guarnizione vetro interna in PVC 4 mm
AGP 3105	Guarnizione vetro interna in PVC 5 mm
AGP 3106	Guarnizione vetro interna in PVC 6 mm
AGP 3107	Guarnizione vetro interna in PVC 7 mm
AGP 3108	Guarnizione vetro interna in PVC 8 mm
AGP 3110	Guarnizione vetro interna in PVC 10 mm
AGP 3123	Guarnizione vetro interna pretagliata in EPDM 2/3 mm. Consente la piega a 90° senza taglio
AGP 3145	Guarnizione vetro interna pretagliata in EPDM 4/5 mm. Consente la piega a 90° senza taglio
AGP 3167	Guarnizione vetro interna pretagliata in EPDM 6/7 mm. Consente la piega a 90° senza taglio
AGP 4000	Guarnizione di battuta in EPDM
AGP 4002	Guarnizione isolamento perimetrale muro - telaio
AGP 4003	Guarnizione di battuta a base rigida in elaprene
AGP 4004	Guarnizione di battuta in EPDM coestruso
AGP 4005	Guarnizione di battuta per riporto centrale lato semifisso per versione doppia battuta
AGP 4006	Guarnizione di battuta per riporto centrale lato semifisso per versione giunto aperto
AGP 4008	Guarnizione copricava telaio
AGP 4010	Guarnizione di battuta in EPDM







AGP 4013	Guarnizione vetro esterna in EPDM 2.5 mm
AGP 4014	Guarnizione vetro esterna in EPDM 4 mm
AGP 4015	Guarnizione acustica di battuta esterna, coestrusa con base rigida sostituibile
AGP 4103	Guarnizione vetro interna in EPDM 2.5/3.5 mm per isolamento acustico e termico
AGP 4106	Guarnizione vetro interna in EPDM 4/6 mm per isolamento acustico e termico
AGP 4113	Guarnizione vetro esterna in coestruso EPDM/SPUGNA da 2.5 mm per isolamento acustico e termico
AGP 4123	Guarnizione vetro esterna in EPDM da 2,5 mm a baffo per siliconare. Garantisce maggiore ermeticità
AGP 4135	Guarnizione vetro esterna in EPDM da 3,5 mm a baffo per siliconare. Garantisce maggiore ermeticità
AGP 4203	Guarnizione vetro interna in 3 mm filo fermavetro
AGP 4204	Guarnizione vetro interna in 4 mm filo fermavetro
AGP 4205	Guarnizione vetro interna in 5 mm filo fermavetro
AGP 4206	Guarnizione vetro interna in 6 mm filo fermavetro
AGP 4501R	Guarnizione di battuta centrale giunto aperto
AGP 4807	Spazzolino dim. 4,8 X 7 mm per sottoporta
AGP 4885R	Angolo vulcanizzato 40X40 mm per pinna AGP 4501R
AGP 5806	Spazzolino dim. 5,8 X 6 mm per profili monoblocco
AGP 5813	Spazzolino dim. 5,8 X 13 mm per celino monoblocco
AGP 6280	Guarnizione di giunzione telai
AGP 7005	Guarnizione vetro esterna da 3 mm, consente la piega a 90° senza taglio
AGP 7007	Guarnizione vetro esterna da 3 mm, filo alluminio, consente la piega a 90° senza taglio
AGP 7202	Guarnizione sottoporta per PL 2055







Elenco guarnizioni

	AGG 3000 Guarnizione di battuta per telai capannoni e imbotti porte interne metri confez. 100
	AGP 4000 Guarnizione di battuta in EPDM metri confez. 400
	AGP 4010 Guarnizione di battuta in EPDM metri confez. 400
	AGP 4003 Guarnizione di battuta a base rigida in elaprene metri confez. 800
	AGP 4004 Guarnizione di battuta in EPDM coestruso metri confez. 300
	AGP 4005 Guarnizione di battuta per riporto centrale lato semifisso per versione doppia battuta metri confez. 300

	AGP 4006 Guarnizione di battuta per riporto centrale lato semifisso per versione giunto aperto metri confez. 300
	AGP 3002 Guarnizione vetro interna in EPDM 2 mm metri confez. 150
	AGP 3003 Guarnizione vetro interna in EPDM 3 mm metri confez. 100
	AGP 3005 Guarnizione vetro interna in EPDM 5 mm metri confez. 100
	AGP 3101 Guarnizione vetro interna in PVC 1 mm
	AGP 3102 Guarnizione vetro interna in PVC 2 mm metri confez. 1000

	AGP 3103 Guarnizione vetro interna in PVC 3 mm metri confez. 600
	AGP 3104 Guarnizione vetro interna in PVC 4 mm metri confez. 500
	AGP 3105 Guarnizione vetro interna in PVC 5 mm metri confez. 360
	AGP 3106 Guarnizione vetro interna in PVC 6 mm metri confez. 250
	AGP 3107 Guarnizione vetro interna in PVC 7 mm metri confez. 200
	AGP 3108 Guarnizione vetro interna in PVC 8 mm metri confez. 160
	AGP 3110 Guarnizione vetro interna in PVC 10 mm metri confez. 140

	AGP 3123 Guarnizione vetro interna pretagliata in EPDM 2/3 mm. Consente la piega a 90° senza taglio metri confez. 200
	AGP 3145 Guarnizione vetro interna pretagliata in EPDM 4/5 mm. Consente la piega a 90° senza taglio metri confez. 200
	AGP 3167 Guarnizione vetro interna pretagliata in EPDM 6/7 mm. Consente la piega a 90° senza taglio metri confez. 150
	AGP 4103 Guarnizione vetro interna in EPDM 2.5/3.5 mm per isolamento acustico e termico metri confez. 100
	AGP 4106 Guarnizione vetro interna in EPDM 4/6 mm per isolamento acustico e termico metri confez. 80
	AGP 4203 Guarnizione vetro interna in 3 mm filo fermavetro metri confez. 200
	AGP 4204 Guarnizione vetro interna in 4 mm filo fermavetro metri confez. 200

	AGP 4205 Guarnizione vetro interna in 5 mm filo fermavetro metri confez. 200
	AGP 4206 Guarnizione vetro interna in 6 mm filo fermavetro metri confez. 200
	AGP 4013 Guarnizione vetro esterna in EPDM 2.5 mm metri confez. 200
	AGP 4014 Guarnizione vetro esterna in EPDM 4 mm metri confez. 200
	AGP 4113 Guarnizione vetro esterna in coestruso EPDM/SPUGNA da 2.5 mm per isolamento acustico e termico metri confez. 100
	AGP 4123 Guarnizione vetro esterna in EPDM da 2,5 mm a baffo per siliconare. Garantisce maggiore ermeticità metri confez. 150
	AGP 4135 Guarnizione vetro esterna in EPDM da 3,5 mm a baffo per siliconare. Garantisce maggiore ermeticità metri confez. 150

	AGP 7005 Guarnizione vetro esterna da 3 mm, consente la piega a 90° senza taglio metri confez. 250
	AGP 7007 Guarnizione vetro esterna da 3 mm, filo alluminio, consente la piega a 90° senza taglio metri confez. 250
	AGP 4015 Guarnizione acustica di battuta esterna, coestrusa con base rigida sostituibile metri confez. 750
	AGG 3092 Giunto per finestre a nastro metri confez. 65
	AGP 4008 Guarnizione copricava telaio metri confez. 200
	AGP 4002 Guarnizione isolamento perimetrale muro - telaio metri confez. 200
	AGP 6280 Guarnizione di giunzione telai metri confez. 300

	<p>AGP 7202</p> <p>Guarnizione sottoporta per PL 2055</p> <p>metri confez. 100</p>
	<p>AGP 4501R</p> <p>Guarnizione di battuta centrale giunto aperto</p> <p>metri confez. 90</p>
	<p>AGP 4885R</p> <p>Angolo vulcanizzato 40X40 mm per pinna AGP 4501R</p> <p>pezzi confez. 100</p>
	<p>ACP 5058</p> <p>Rotella infila guarnizioni</p> <p>pezzi confez. 1</p>

	<p>AGP 4807</p> <p>Spazzolino dim. 4,8 X 7 mm per sottoporta</p> <p>metri confez. 325</p>
	<p>AGP 5806</p> <p>Spazzolino dim. 5,8 X 6 mm per profili monoblocco</p> <p>metri confez. 100</p>
	<p>AGP 5813</p> <p>Spazzolino dim. 5,8 X 13 mm per celino monoblocco</p> <p>metri confez. 150</p>

Elenco accessori generici

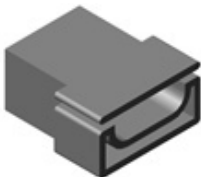
	ACP 5079 tappo riporto centrale Planet 45 versione giunto aperto coppie confez. 250
	ACP 5083 Tappo riporto centrale Planet 45 versione doppia battuta pezzi confez. 50
	ACP 5023 Tappo anti intestatura per profili vetro infilare spazio 25 mm pezzi confez. 50
	AC 2028 Tappo scarico acqua coppie confez. 200
	AC 2077 kit registrazione vetro per ante vetro ad infilare kit confez. 100
	AC 2099 Tappino chiudiforo ø 11.5mm pezzi confez. 1000
	ACP 5014 Angolino per fermavetri maggiorati PL 1521, PL 1525, PL 1528, PL 1532 pezzi confez. 160

	ACP 5027 Gommino blocca fermavetro per PL 1325 pezzi confez. 100
	ACP 5035 Regolo a muro in nylon pezzi confez. 250
	ACP 5036 Regolo a muro in metallo pezzi confez. 100
	ACP 5099 Regolo a muro rialzato per telai con camera intermedia coppie confez. 100
	ACP 5093 Tappi cassonetto coppie confez. 1
	ACP 5095 Inviti guida tapparella coppie confez. 50
	ACP 50010 Avvolgitore senza placca pezzi confez. 1

	ACP 50011 Placca per avvolgitore pezzi confez. 1
	ACP 50095 Guida cinghia a cassonetto pezzi confez. 1
	ACP 50117D Mensola destra per supporto a squadra ACP 50220 coppie confez. 1
	ACP 50117S Mensola sinistra per supporto a squadra ACP 50220 coppie confez. 1
	ACP 50120D Mensola destra per supporto verticale ACP 50320 coppie confez. 1
	ACP 50120S Mensola sinistra per supporto verticale ACP 50320 coppie confez. 1
	ACP 50220 Supporto a squadra 46x10 rullo tapparella coppie confez. 1
	ACP 50320 Supporto verticale 40x5 rullo tapparella coppie confez. 1

	ACP 50704 Cassetta semi incasso pezzi confez. 1
	ACP 50705 Avvolgitore con placca nera per cinghia tapparella pezzi confez. 1
	ACP 50825 Puleggia da 180 mm pezzi confez. 1
	ACP 50832 Calotta di supporto per rullo pezzi confez. 1
	ACP 51001 Guida cinghia da montante pezzi confez. 200
	ACP 51190 Boccola di giunzione rullo/puleggia rullo/calotta pezzi confez. 1
	ACP 51520 Vite di fissaggio supporto/mensola
	ACP 50118 Nastro magnetico in acciaio per sistema oscurante Easysun Metri confez. 240

Elenco accessori per giunzione

	AC 2001 Vite trilobata per cavallotto ACP 50420 pezzi confez. 250
	AC 5000 Spina ø 8mm per cavallotto ACP 50420 pezzi confez. 400
	ACP 5001 Vite ø 8 per squadretta multifunzione ACP 5801, ACP 5802, ACP 7001 pezzi confez. 1000
	ACP 5002 Squadretta 23x14 mm a pulsante ø10 mm - filettata pezzi confez. 250
	ACP 5008 Squadretta allineamento in acciaio inox pezzi confez. 400
	ACP 50420 Cavallotto 23x14 mm a scatto in estruso pezzi confez. 100

	ACP 50454 Cavallotto a scatto in estruso per PL 2038 pezzi confez. 100
	ACP 5084 Squadretta allineamento con vite di tiraggio per telai e imbotti pezzi confez. 250
	ACP 50110 Squadretta allineamento con eccentrici di tiraggio pezzi confez. 250
	ACP 5501 Squadretta maggiorata 23x35 mm a pulsante ø10 mm pezzi confez. 250
	ACP 5504 Squadretta 23x14 mm angolo variabile min.30° max 178° pezzi confez. 20
	ACP 5506 Squadretta maggiorata 23x35 mm angolo variabile min. Angolo 55° max 315° pezzi confez. 20

	<p>ACP 5521</p> <p>Cavallotto 23x14 mm in pressofuso a pulsante</p> <p>coppie confez. 250</p>
	<p>ACP 5800</p> <p>Spina per squadretta multifunzione ACP 5801, ACP 5802 , ACP 7001</p> <p>pezzi confez. 1000</p>
	<p>ACP 5801</p> <p>Squadretta 23x14 mm multifunzione, avvitare, spinare o cianfrinare abbinare con ACP 5800 per spinare e ACP 5001 per avvitare</p> <p>pezzi confez. 200</p>







	<p>ACP 5802</p> <p>Squadretta maggiorata 23x35 mm multifunzione, avvitare, spinare o cianfrinare. Abbinare con ACP 5800 per spinare e ACP 5001 per avvitare</p> <p>pezzi confez. 100</p>
	<p>ACP 5805</p> <p>Squadretta 23x14 mm angolo variabile strong min.60° max 120°</p> <p>pezzi confez. 20</p>
	<p>ACP 5821</p> <p>Cavallotto 23x14 mm in pressofuso con grano e codulo</p> <p>pezzi confez. 250</p>

Elenco accessori di chiusura

	<p>AC 2068</p> <p>Maniglia tavellino piccola</p> <p>pezzi confez. 25</p>		<p>ACP 5034</p> <p>Cremonese con chiave</p> <p>pezzi confez. 20</p>
	<p>AC 2069</p> <p>Cerniera scuretto</p> <p>pezzi confez. 50</p>		<p>ACP 5033</p> <p>Cremonese senza manico</p> <p>pezzi confez. 20</p>
	<p>ACP 5076</p> <p>Maniglia a tavellino</p> <p>pezzi confez. 20</p>		<p>ACP 5032</p> <p>Manico per cremonese</p> <p>pezzi confez. 40</p>
	<p>ACP 50152</p> <p>Martellina 90-180° quadro 7 mm</p> <p>pezzi confez. 5</p>		<p>ACP 50101</p> <p>Piastrino anti rollio per cremonese ACP 50100</p> <p>pezzi confez. 10</p>
	<p>ACP 50100</p> <p>Cremonese bidirezionale Giada</p> <p>pezzi confez. 20</p>		<p>ACP 5037</p> <p>Cremonese monodirezionale con impugnatura lunga per anta ribalta e scorrevole parallelo.</p> <p>pezzi confez. 1</p>
	<p>ACP 50107</p> <p>Basetta in nylon sagomata per cremonese Giada</p> <p>pezzi confez. 20</p>		<p>ACP 50104</p> <p>Cremonese apertura esterna</p> <p>pezzi confez. 20</p>

	<p>ACP 50105</p> <p>kit apertura esterna di collegamento per ACP 50104</p> <p>kit confez. 50</p>
	<p>ACP 50106</p> <p>Perno 16 mm di trascinamento asta cremonese per ACP 50105</p> <p>pezzi confez. 500</p>
	<p>ACP 5045</p> <p>Blocchetti collegamento cremonese in zama</p> <p>coppie confez. 160</p>
	<p>ACP 5039</p> <p>Doppia maniglia per porte</p> <p>coppie confez. 20</p>
	<p>ACP 50111</p> <p>Kit angoli di rinvio x movimento asta a leva anta affiancata</p> <p>Kit confez. 10</p>
	<p>ACP 50109</p> <p>Movimento asta a leva anta affiancata</p> <p>pezzi confez. 20</p>

	<p>ACP 5022</p> <p>Catenacciolo</p> <p>pezzi confez. 100</p>
	<p>ACP 5025</p> <p>Terminale asta</p> <p>pezzi confez. 200</p>
	<p>ACP 5052</p> <p>Kit catenaccioli in alluminio con eccentrico di registrazione per anta semifissa</p> <p>kit confez. 20</p>
	<p>ACP 5053</p> <p>Giunzione astina per prolunga catenaccioli ACP 5052</p> <p>pezzi confez. 100</p>
	<p>ACP 5024</p> <p>Incontro asta doppio in zama</p> <p>pezzi confez. 400</p>
	<p>ACP 5081</p> <p>Incontro asta singolo in nylon</p> <p>pezzi confez. 100</p>







	ACP 5082 Incontro asta doppio in nylon pezzi confez. 100
	ACP 5019 Riscontro 3a chiusura pezzi confez. 200
	ACP 5021 Kit 3a chiusura registrabile pezzi confez. 100
	ACP 5026 Piastra sostegno anta pezzi confez. 400
	ACP 5005 Cerniera componenti inox e piastrini premontati, per telai piani, usare 1 coppia $h_{max}=1800$ mm per h oltre 1800 mm inserire la 3 ^a cerniera pezzi confez. 50
	ACP 5005D Cerniera premontata destra, per telai piani, usare 1 coppia $h_{max}=1800$ mm per h oltre 1800 mm inserire la 3 ^a cerniera







	ACP 5005S Cerniera premontata sinistra, per telai piani, usare 1 coppia $h_{max}=1800$ mm per h oltre 1800 mm inserire la 3 ^a cerniera pezzi confez. 50
	ACP 5006 Cerniera 3 ali componenti inox e piastrini premontati, per telai piani pezzi confez. 25
	ACP 5007 Cerniera 3 ^a anta componenti inox e piastrini premontati, usare 1 coppia $h_{max}=1800$ mm per h oltre 1800 mm inserire la 3 ^a cerniera pezzi confez. 50
	ACP 5007D Cerniera 3 ^a anta premontata destra, usare 1 coppia $h_{max}=1800$ mm per h oltre 1800 mm inserire la 3 ^a cerniera pezzi confez. 50
	ACP 5007S Cerniera 3 ^a anta premontata sinistra, usare 1 coppia $h_{max}=1800$ mm per h oltre 1800 mm inserire la 3 ^a cerniera pezzi confez. 50
	ACP 5043 Kit cerniere per anta abbinata telai piani (Complanare esterno Sormonto interno) coppie confez. 10

	<p>ACP 5044</p> <p>Kit cerniere per anta abbinata telai modanati (Complanare esterno Complanare interno)</p> <p>coppie confez. 10</p>
	<p>ACP 5069</p> <p>Cerniera 3 ali 3^a anta componenti inox e piastrini premontati,</p> <p>pezzi confez. 25</p>
	<p>ACP 9918</p> <p>Cerniera Strong a 2 ali per telai filiformi (complanare Esterno sormonto Interno) vedere schede di montaggio</p> <p>pezzi confez. 20</p>
	<p>ACP 9938</p> <p>Cerniera Strong 2 ali, 3^a anta anche per telai filiformi (complanare Esterno complanare Interno) vedere schede di montaggio</p> <p>pezzi confez. 20</p>
	<p>ACP 99124</p> <p>Cover per cerniera ACP 9918 e ACP 9938</p> <p>pezzi confez. 20</p>
	<p>ACP 99125</p> <p>Piastrino universale di registrazione verticale delle ante per le cerniere strong ACP 9918 e ACP 9938</p> <p>pezzi confez. 10</p>





	<p>ACP 99126</p> <p>Chiave per montaggio cerniera ACP 9918 e ACP 9938</p> <p>pezzi confez. 1</p>
	<p>ACP 9963/60</p> <p>Cerniera frontale, 3 ali int. 60 mm</p> <p>pezzi confez. 10</p>
	<p>ACP 9963/93</p> <p>Cerniera frontale, 3 ali int. 93 mm</p> <p>pezzi confez. 10</p>
	<p>ACP 9964/60</p> <p>Cerniera frontale 2 ali int. 60 mm</p> <p>pezzi confez. 20</p>
	<p>ACP 9964/93</p> <p>Cerniera frontale 2 ali int. 93 mm</p> <p>pezzi confez. 20</p>
	<p>ACP 9909</p> <p>Spessore 8 mm per cerniere ad applicazione frontale</p> <p>pezzi confez. 50</p>

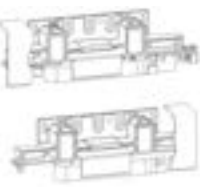
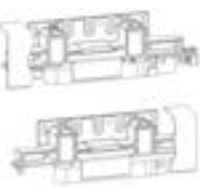

	ACP 9915 Spessore 7 mm per cerniere ad applicazione frontale pezzi confez. 50
	ACP 9973 Kit fissaggio cerniere applicazione frontale 2 ali kit confez. 10
	ACP 9974 Kit fissaggio cerniere applicazione frontale 3 ali kit confez. 10
	ACP 9998 Dima di foratura per cerniere applicazione frontale pezzi confez. 1
	ACP 5010 Cerniera vasistas doppio scatto coppie confez. 20
	ACP 5011 Bracci sporgere telescopici coppie confez. 20

	ACP 5012 Cerniera vasistas scatto singolo coppie confez. 25
	ACP 5016 Braccio sganciabile inox coppie confez. 40
	ACP 5013 Cricchetto vasistas pezzi confez. 100
	ACP 5017 Cricchetto vasistas applicazione rapida pezzi confez. 50
	ACP 50150 Kit anta ribalta con cerniere e cremonese, per telai piani (Complanare esterno Sormonto interno) kit confez. 1
	ACP 50151 Kit anta ribalta con cerniere e cremonese, per telai complanari (Complanare esterno, Complanare interno) kit confez. 1

	ACP 5085 Kit anta ribalta fulcro orizzontale Kit confez. 1
	ACP 5046/350 Braccio ribalta 345/410 mm pezzi confez. 10
	ACP 5046/411 Braccio ribalta 411/540 mm pezzi confez. 10
	ACP 5046/541 Braccio ribalta 541/1500 mm pezzi confez. 10
	ACP 5047 Kit chiusura anta abbinata pezzi confez. 10
	ACP 5049 Braccio supplementare pezzi confez. 10

	ACP 5056 Kit chiusura supplementare orizzontale kit confez. 1
	ACP 5057 Kit chiusura supplementare verticale kit confez. 5
	ACP 5090 Frizione bilico senza fermo, portata 75 Kg coppie confez. 3
	ACP 5091 Frizione bilico con fermo, portata 75 Kg coppie confez. 3
	ACP 5086 Kit chiusura 4 punti bilico verticale kit confez. 1
	ACP 5088 Kit chiusura 4 punti bilico orizzontale Kit confez. 1

	<p>ACP 50159D</p> <p>Kit carrelli scorrevole parallelo destro portata 150kg</p> <p>Kit confez. 1</p>
	<p>ACP 50159S</p> <p>Kit carrelli scorrevole parallelo sinistro portata 150kg</p> <p>Kit confez. 1</p>
	<p>ACP 50160/1100</p> <p>Kit binari per scorrevole parallelo L anta = da 851 mm a 1100 mm</p> <p>Kit confez. 1</p>
	<p>ACP 50160/1350</p> <p>Kit binari per scorrevole parallelo L anta = da 1101 mm a 1350 mm</p> <p>Kit confez. 1</p>
	<p>ACP 50160/1600</p> <p>Kit binari per scorrevole parallelo L anta = da 1351 mm a 1600 mm</p> <p>Kit confez. 1</p>
	<p>ACP 50161/1200</p> <p>Kit forbici scorrevole parallelo soluzione manuale per ante fino a 1200 mm, abbinare ad ACP 50165</p> <p>Kit confez. 1</p>

	<p>ACP 50162</p> <p>Kit forbici scorrevole parallelo soluzione automatica per ante fino a 2000 mm</p> <p>fino a 1600 mm di anta utilizzare ACP 50159, da 1600 a 2000 mm occorrono carrelli con portata 180 Kg</p> <p>KIT DISPONIBILE SU RICHIESTA ABBINARE ALLA MANIGLIA ACP 50170</p>
	<p>ACP 50163</p> <p>Kit accessori per trasformare il kit manuale ACP 50161 in semiautomatico per profili a camera europea da abbinare ad ACP 50166</p> <p>Kit confez. 1</p>
	<p>ACP 50164</p> <p>Kit copertura disponibile nelle colorazioni argento, RAL 9010 e nero elettro-colore</p> <p>Kit confez. 1</p>
	<p>ACP 50165</p> <p>Spessori per forbici da abbinare con ACP50161/1200 o ACP 50162 Disponibile nelle colorazioni argento e nero elettro-colore</p> <p>Kit confez. 1</p>
	<p>ACP 50166</p> <p>Placchetta di fermo - per trasformare il kit forbici manuale in semiautomatico da abbinare ad ACP 50163</p> <p>pezzi confez. 1</p>
	<p>ACP 50167</p> <p>Kit supplementare per ante oltre i 1200 mm da abbinare alle astine ACP 50168 e ACP 50169</p> <p>Kit confez. 1</p>

	<p>ACP 50168</p> <p>Astina per kit supplementare per ante da 1201 mm fino a 1350 mm</p> <p>pezzi confez. 1</p>
	<p>ACP 50169</p> <p>Astina per kit supplementare per ante da 1351 mm fino a 1600 mm</p> <p>pezzi confez. 1</p>

	<p>ACP 50170</p> <p>Maniglia quadro 10 mm per kit automatico scorrevole parallelo ACP 50162. Disponibile nei colori argento e nero RAL 9010</p> <p>pezzi confez. 1</p>
---	---

finestra 1 anta versione doppia battuta

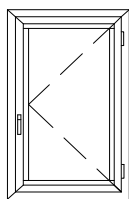

distinta vetri

nr. pezzi	L	H
1	L-148	H-148

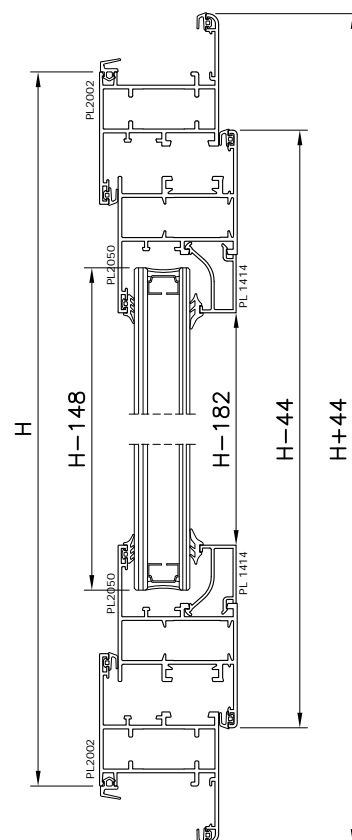
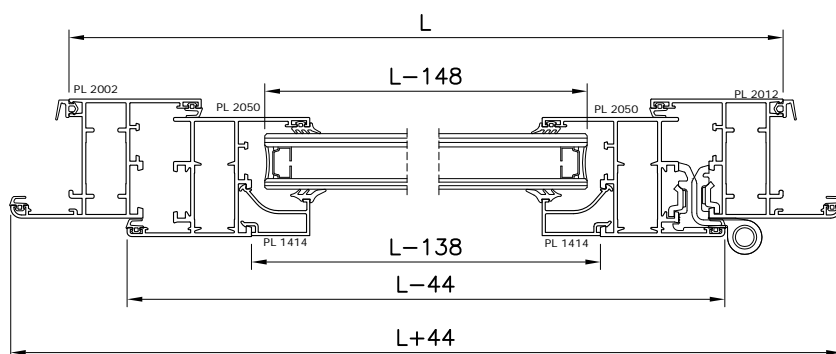

distinta profili

articolo	descrizione	pezzi	misura	taglio
PL 2002	montante telaio	2	H+44	
	traverso telaio	2	L+44	
PL 2050	montante anta	2	H-44	
	traverso anta	2	L-44	
PL 1414	montante fermavetro	2	H-182	
	traverso fermavetro	2	L-138	

distinta accessori

articolo	descrizione	q.tà
ACP 5801	squadretta multifunzione	8 pz
ACP 5001	vite per ACP 5801	16 pz
ACP 5005	cerniera	2 pz
ACP 5008	squadretta all. inox	8 pz
ACP 50100	cremonese giada	1 pz
ACP 5025	terminale asta	2 pz
ACP 5045	blocchetti collegamento	1 cp
ACP 5035	regolo muro nylon	4 pz
ACP 5081	incontro	2 pz

distinta guarnizioni

articolo	descrizione	pezzi	misura
AGP 4000	battuta	2	L+44
		2	L-44
		2	L-80
		2	H+44
		2	H-44
		2	H-80
dipende dal vetro	vetro interna	2	L-148
		2	H-148
AGP 4013	vetro esterna	2	L-148
		2	H-148
AGP 4002	isolamento muro	2	L+20
		2	H+20

finestra 1 anta ribalta giunto aperto



distinta vetri

nr. pezzi	L	H
1	L-148	H-148

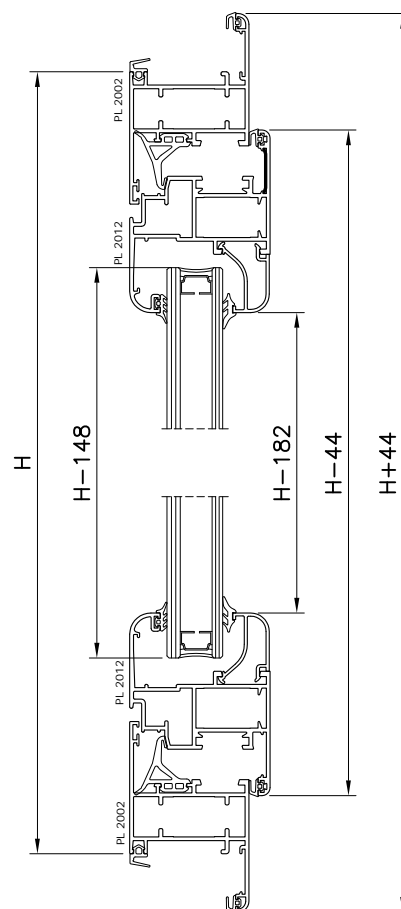
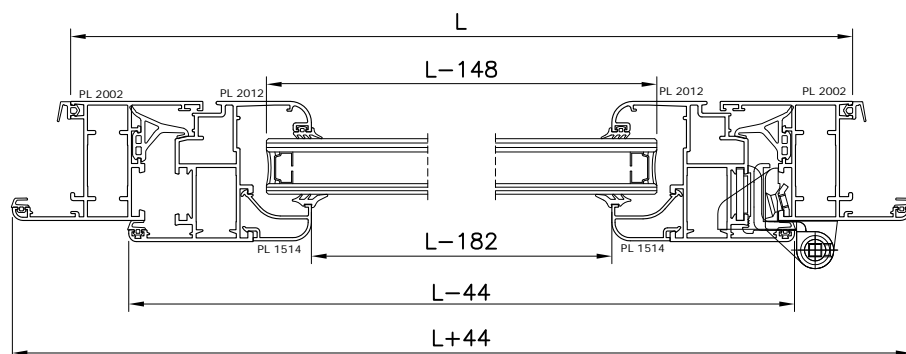

distinta profili

articolo	descrizione	pezzi	misura	taglio
PL 2002	traverso telaio Z	2	L+44	
	montante telaio Z	2	H+44	
PL 2012	montante anta	2	H-44	
	traverso anta	2	L-44	
PL 1514	montante fermavetro	2	H-182	
	traverso fermavetro	2	L-182	

distinta accessori

articolo	descrizione	q.tà
ACP 5801	squadretta multifunzione	8 pz
ACP 5001	vite per ACP 5801	16 pz
ACP 5008	squadretta all. inox	8 pz
ACP 50150	kit anta a ribalta	1 pz
ACP 5046	braccio ribalta	1 pz
ACP 5035	regolo muro nylon	4 pz
ACP 50110	squadretta all. eccentrico	4 pz
AGP 4885R	angolo vulcanizzato	4 pz
ACP 5014	angolino fermavetro	4 pz

distinta guarnizioni

articolo	descrizione	pezzi	misura
AGP 4000		2	L+44
		2	H+44
		2	L-44
		2	H-44
AGP 3104		2	L-148
		2	H-148
AGP 4013		2	L-148
		2	H-148
AGP 4002		2	L+20
		2	H+20
AGP 4501R		2	L-124
		2	H-124

finestra 2 ante giunto aperto

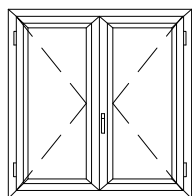

distinta vetri

nr. pezzi	L	H
2	L/2-128	H-148

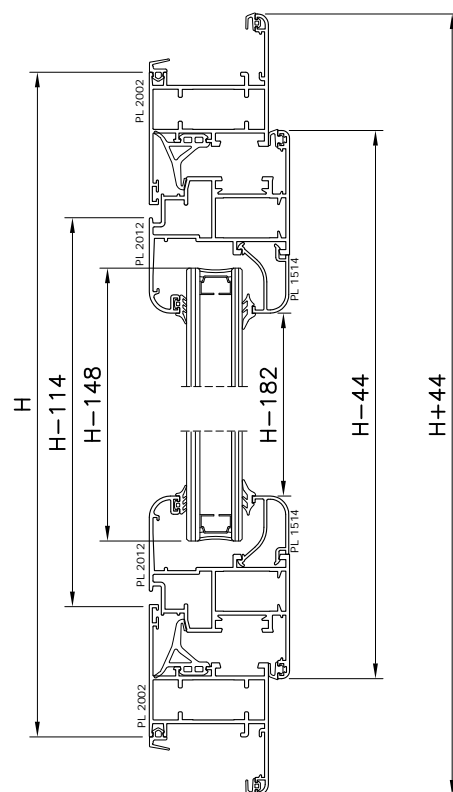
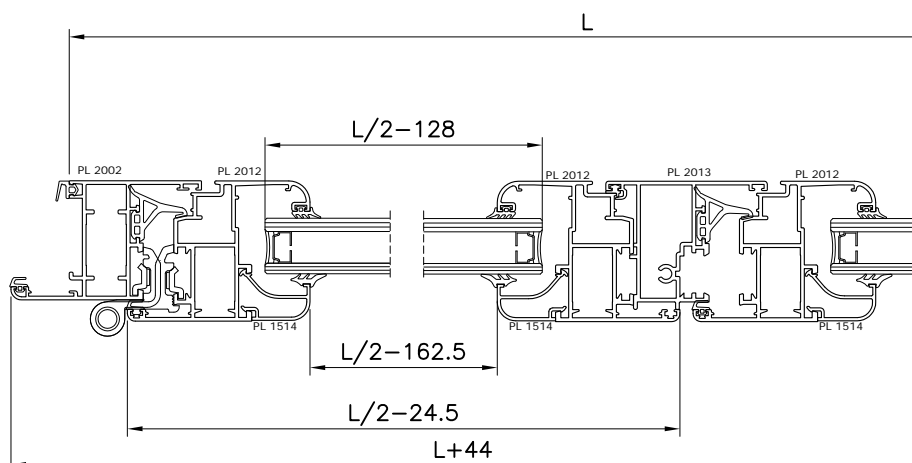

distinta profili

articolo	descrizione	pezzi	misura	taglio
PL 2002	traverso telaio Z	2	L+44	
	montante telaio Z	2	H+44	
PL 2013	riporto centr. dritto	1	H-114	
PL 2012	montante anta	4	H-44	
	traverso anta	4	L/2-24.5	
PL 1514	fermavetro raggiato	4	H-182	
	fermavetro raggiato	4	L/2-162.5	

distinta accessori

articolo	descrizione	q.tà
ACP 5801	squadretta multifunzione	12 pz
ACP 5001	vite per ACP 5801	24 pz
ACP 5008	squadretta all. inox	12 pz
ACP 5005	cerniera	4 pz
ACP 50100	cremonese giada	1 pz
ACP 5025	terminale asta	1 pz
ACP 5022	catenacciolo	2 pz
ACP 5079	tappo riporto	1 cp
ACP 5035	regolo muro nylon	4 pz
ACP 50110	squadretta all. eccentrico	8 pz
ACP 5014	angolino fermavetro	8 pz
AGP 4885R	angolo vulcanizzato	4 pz
ACP 5045	blocchetti collegamento	1 cp
ACP 5024	incontro asta	2 pz

distinta guarnizioni

articolo	descrizione	pezzi	misura
AGP 4002		2	L
		2	H
AGP 4501R		2	L-124
		3	H-124
AGP 4000		4	L/2-24.5
		4	H-44
AGP 3005		4	L/2-128
		4	H-148
AGP 4013		4	L/2-128
		4	H-148
		3	H-44
		4	L/2-24.5
AGP 4006		1	H-114

finestra 3 ante giunto aperto

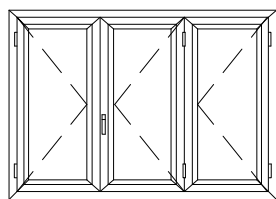

distinta vetri

nr. pezzi	L	H
3	L/3-122	H-148

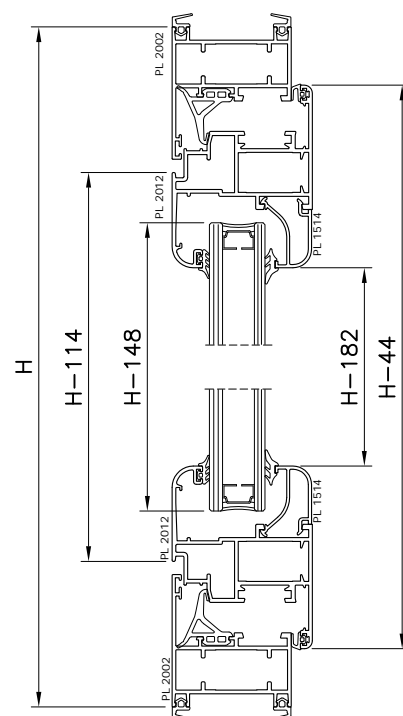
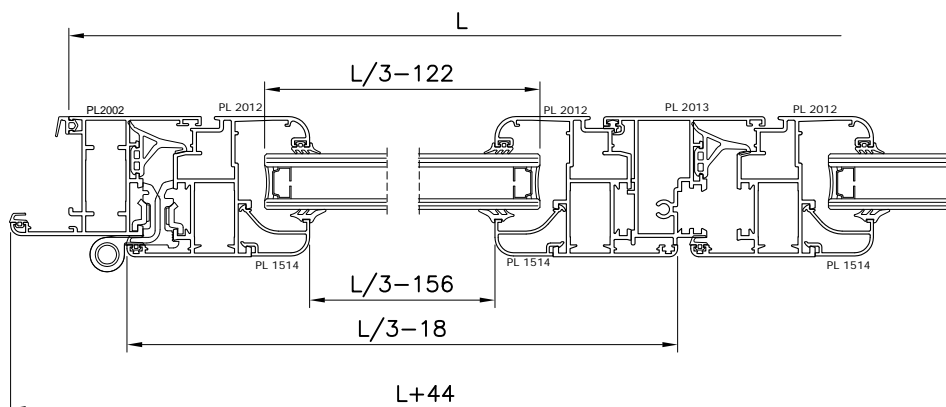

distinta profili

articolo	descrizione	pezzi	misura	taglio
PL 2002	traverso sup. telaio Z montante telaio	1	L+44	
		2	H+44	
PL 2003	traverso inf. telaio L	1	L	
PL 2012	montante anta	6	H-44	
	traverso anta	6	L/3-18	
PL 2013	riporto centr. dritto	2	H-114	
PL 1514	montante fermavetro	6	H-182	
	traverso fermavetro	6	L/3-156	

distinta accessori

articolo	descrizione	q.tà
ACP 5801	squadretta multifunzione	16 pz
ACP 5001	vite per ACP 5801	32 pz
ACP 5008	squadretta all. inox	14 pz
ACP 5005	cerniera	4 pz
ACP 5007	cerniera terza anta	2 pz
ACP 50100	cremonese giada	1 pz
ACP 5025	terminale asta	2 pz
ACP 5022	catenacciolo	4 pz
ACP 5079	tappo riporto	2 cp
ACP 5035	regolo a muro in nylon	4 pz
ACP 50110	squadretta all. eccentrico	12 pz
ACP 5014	angolino fermavetro	12 pz
AGP 4885R	angolo vulcanizzato	4 pz
ACP 5024	incontro asta	4 cp
ACP 5045	blocchetti collegamento	1 cp

distinta guarnizioni

articolo	descrizione	pezzi	misura
AGP 4002	isolamento muro	3	L+20
		2	H+20
AGP 4501R	battuta centrale giunto aperto	2	L-124
		4	H-124
AGP 4000	battuta	3	L+44
		2	H+44
		4	H-44
		6	L/3-18
1	L+44		
AGP 3005	vetro interna	6	L/3-122
		6	H-148
AGP 4013	vetro esterna	6	L/3-112
		6	H-141
AGP 4006	battuta giunto aperto	2	H-114

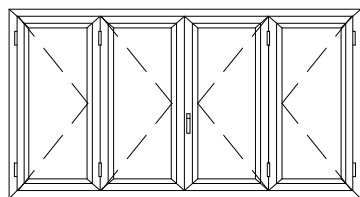

distinta vetri

nr. pezzi	L	H
4	L/4-118	H-148

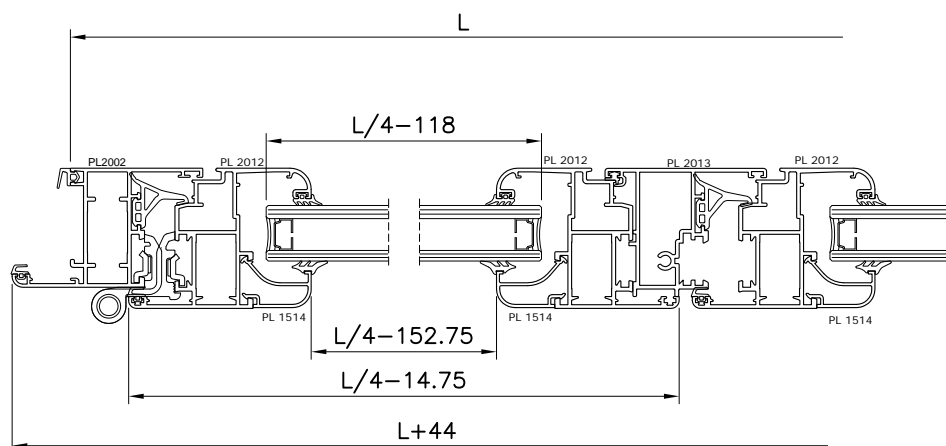
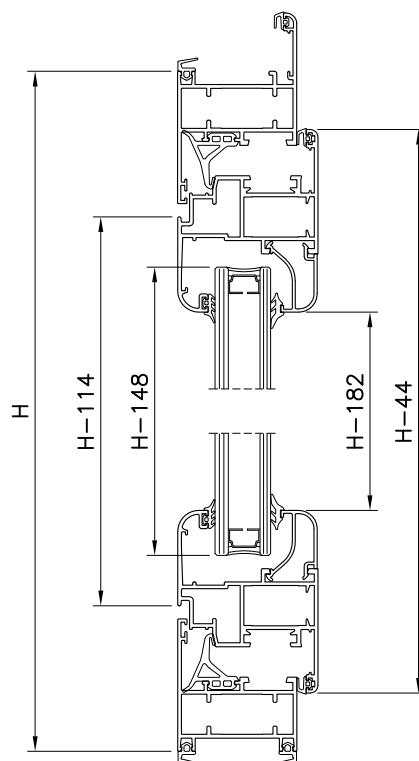

distinta profili

articolo	descrizione	pezzi	misura	taglio
PL 2002	traverso telaio superiore	1	L+44	
	montante telaio	2	H+44	
PL 2012	montante anta	8	H-44	
	traverso anta	8	L/4-14.75	
PL 2013	riporto centrale	3	H-114	
PL 1514	fermavetro arrotondato	8	H-182	
	fermavetro arrotondato	8	L/4-152,75	
PL 2003	traverso telaio inferiore	1	L	

distinta accessori

articolo	descrizione	q.tà
ACP 5801	squadretta multifunzione	20 pz
ACP 5001	vite per ACP 5801	40 pz
ACP 50110	squadretta all. eccentrico	16 pz
ACP 5008	squadretta all. inox	18 pz
ACP 5005	cerniera	4 pz
ACP 5007	cerniera 3 ^a anta	4 pz
ACP 50100	cremonese giada	1 pz
ACP 5025	terminale asta	2 pz
ACP 5022	catenacciolo	6 pz
ACP 5079	tappo riporto	3 cp
ACP 5014	angoli fermavetro	16 pz
ACP 5035	regolo muro nylon	4 pz
AGP 4885R	angolo vulcanizzato	4 pz
ACP 5024	incontro asta	6 pz
ACP 5045	blocchetti collegamento	1 cp

distinta guarnizioni

articolo	descrizione	pezzi	misura	
AGP 4002		isolamento muro	3 2	L+20 H+20
AGP 4501R		battuta centrale giunto aperto	2 5	L-124 H-124
AGP 4000		battuta	1 2 5 8	L+44 H+44 H-44 L/4-14
AGP 3005		vetro interna	8 8	L/4-118 H-148
AGP 4013		vetro esterna	8 8	L/4-118 H-148
AGP 4006		battuta giunto aperto	5	H-114

porta finestra 1 anta giunto aperto

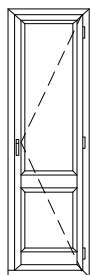

distinta vetri

nr. pezzi	L	H
1	L-148	H1-193
1	L-148	H2-103

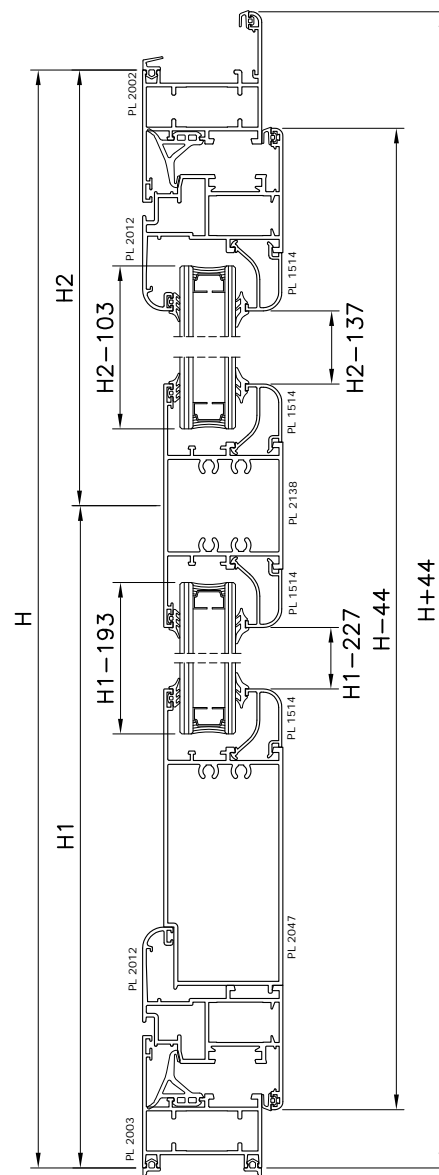
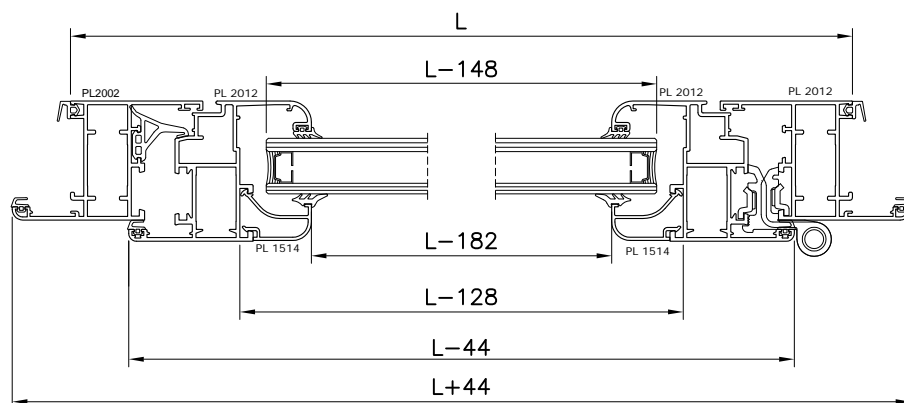

distinta profili

articolo	descrizione	pezzi	misura	taglio
PL 2002	traverso telaio superiore	1	L+44	
	montante telaio	2	H+44	
PL 2003	traverso telaio inferiore	1	L	
PL 2012	montante anta	2	H-44	
	traverso anta	2	L-44	
PL 2138	fascia/traverso	1	L-129	
PL 1514	traverso fermavetro	4	L-182	
	montante fermavetro	2	H1-227	
	montante fermavetro	2	H2-137	
PL 2047	zoccolo riportato	1	L-129	

distinta guarnizioni

articolo	descrizione	pezzi	misura
AGP 4002		3	L+20
		2	H+20
AGP 4501R		2	L-124
		2	H-124
AGP 4000		1	L+44
		2	H-44
		2	L-44
		2	H+44
AGP 3005		4	L-148
		2	H1-193
		2	H2-103
AGP 4013		4	L-148
		2	H1-193
		2	H2-103

distinta accessori

articolo	descrizione	q.tà
ACP 5801	squadretta multifunzione	8 pz
ACP 5001	vite per ACP 5801	16 pz
ACP 5008	squadretta all. inox	6 pz
ACP 5005	cerniera	3 pz
ACP 5081	incontro singolo	2 pz
ACP 50100	cremonese giada	1 pz
ACP 5025	terminale asta	2 pz
ACP 5035	regolo	6 pz
ACP 5045	blocchetti collegamento	1 cp
ACP 5014	angolo fermavetro	8 pz
ACP 50110	squadretta all. eccentrico	4 pz
AGP 4885R	angolo vulcanizzato	4 pz

porta finestra 2 ante giunto aperto

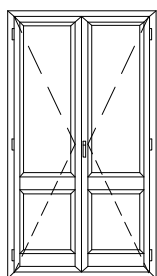

distinta vetri

nr. pezzi	L	H
2	L/2-128.5	H1-263.5
2	L/2-128.5	H2-174.5

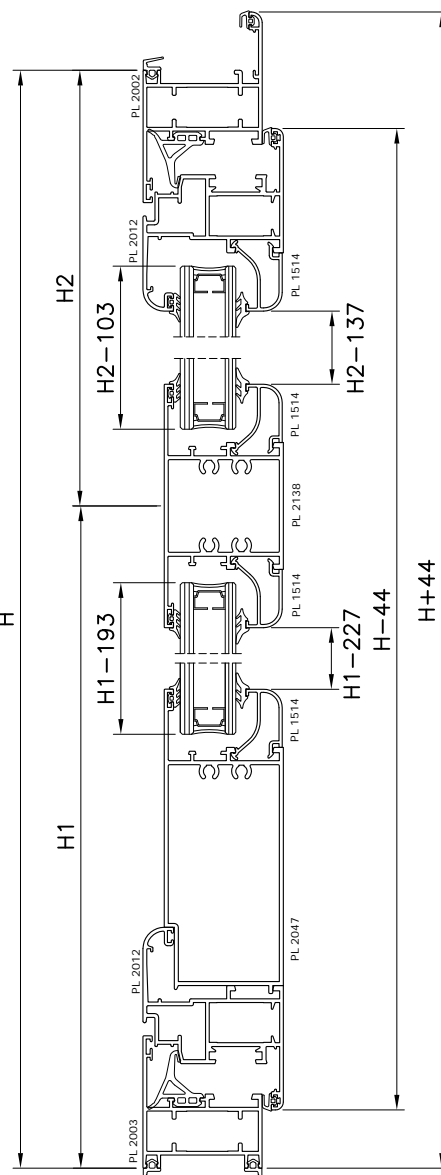
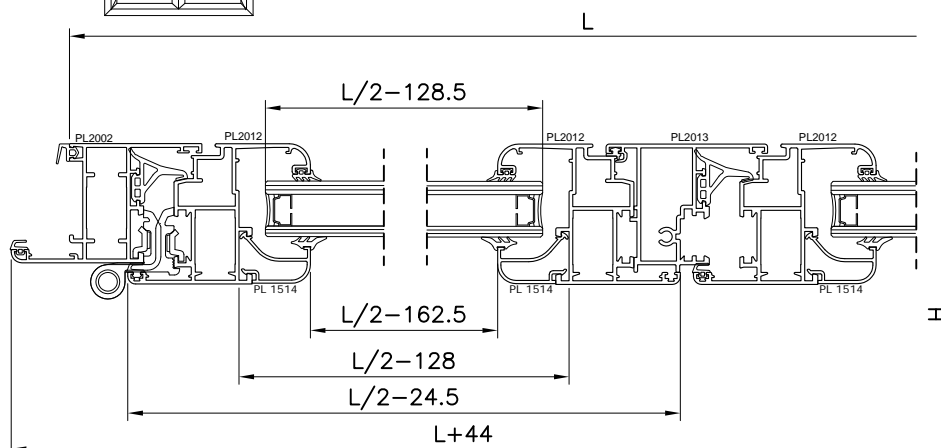

distinta profili

articolo	descrizione	pezzi	misura	taglio
PL 2002	traverso telaio superiore	1	L+44	
	montante telaio	2	H+44	
PL 2003	traverso telaio inferiore	1	L+44	
PL 2138	fascia/traverso	2	L/2-109.5	
PL 2012	traverso anta	4	L/2-24,5	
	montante anta	4	H-44	
PL 2013	riporto centr. dritto	1	H-114	
PL 1514	montante fermavetro	4	H1-227	
	montante fermavetro	4	H2-137	
	traverso fermavetro	8	L/2-162.5	
PL 2047	zoccolo riportato	2	L/2-109.5	

distinta guarnizioni

articolo	descrizione	pezzi	misura
AGP 4002	isolamento muro	2	L+20
		3	H+20
AGP 4000	battuta	1	L+44
		2	H+44
		4	L/2-24.5
AGP 3005	vetro interna	3	H-44
		4	L/2-162.5
		4	H1-227
AGP 4013	vetro esterna	4	H2-137
		4	L/2-162.5
		4	H1-227
AGP 4501R	battuta centrale giunto aperto	2	L-62
		1	L/2-49
AGP 4006	battuta giunto aperto	2	H+62
		1	H-114

distinta accessori

articolo	descrizione	q.tà
ACP 5801	squadretta multifunzione	12 pz
ACP 5001	vite per ACP 5801	24 pz
ACP 5024	incontro	2 pz
ACP 50110	squadretta all. eccentrico	12 pz
ACP 5008	squadretta all. inox	12 pz
ACP 5005	cerniera	6 pz
ACP 50100	cremonese	1 pz
ACP 5022	catenacciolo	2 pz
ACP 5025	terminale asta	2 pz
ACP 5079	tappo riporto	2 cp
ACP 5014	angolini fermavetro	16 pz
ACP 5035	regolo muro nylon	6 pz
ACP 5045	blocchetti	2 pz
ACP 4885R	angolo vulcanizzato	4 pz

apertura interna - battente - nodo laterale

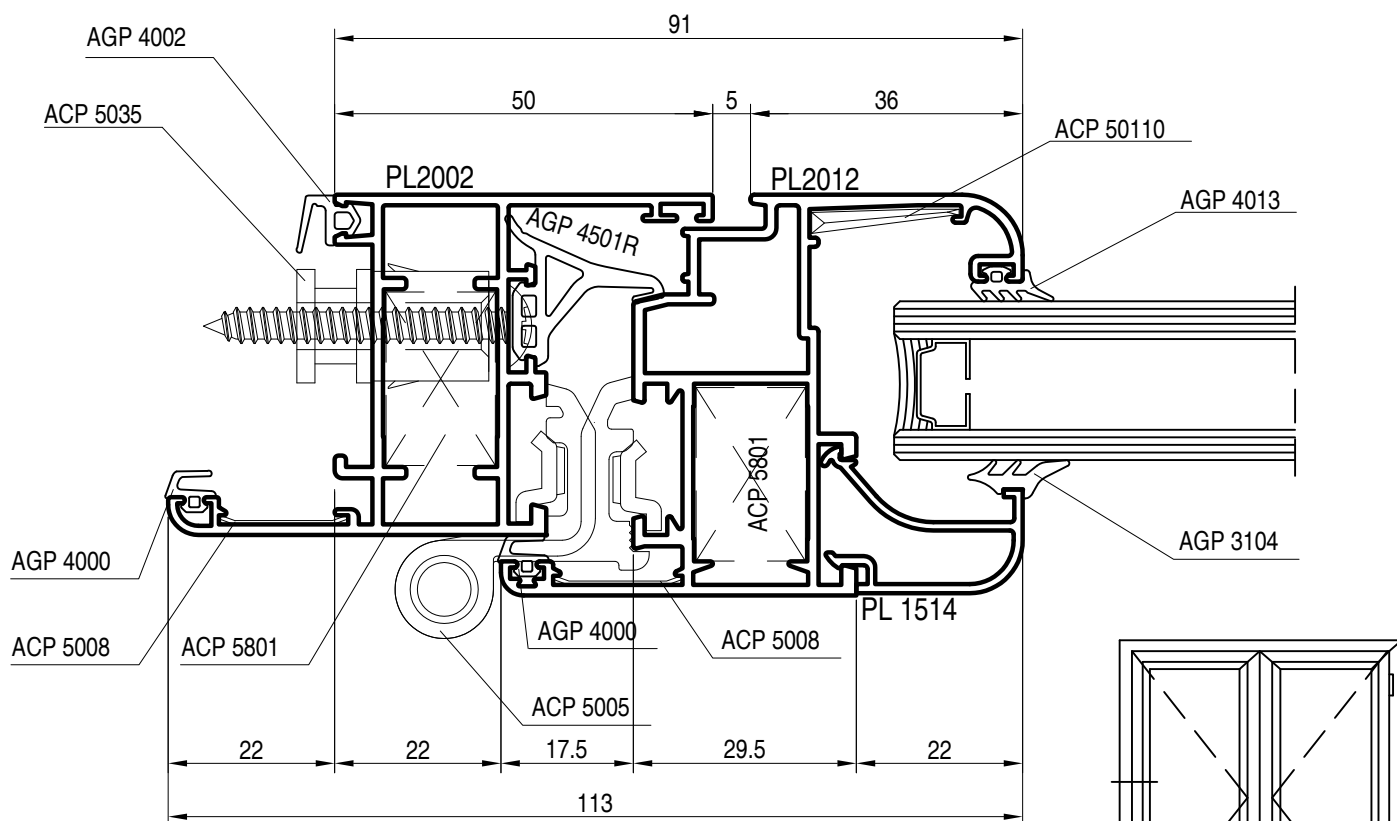

apertura interna - battente - nodo laterale

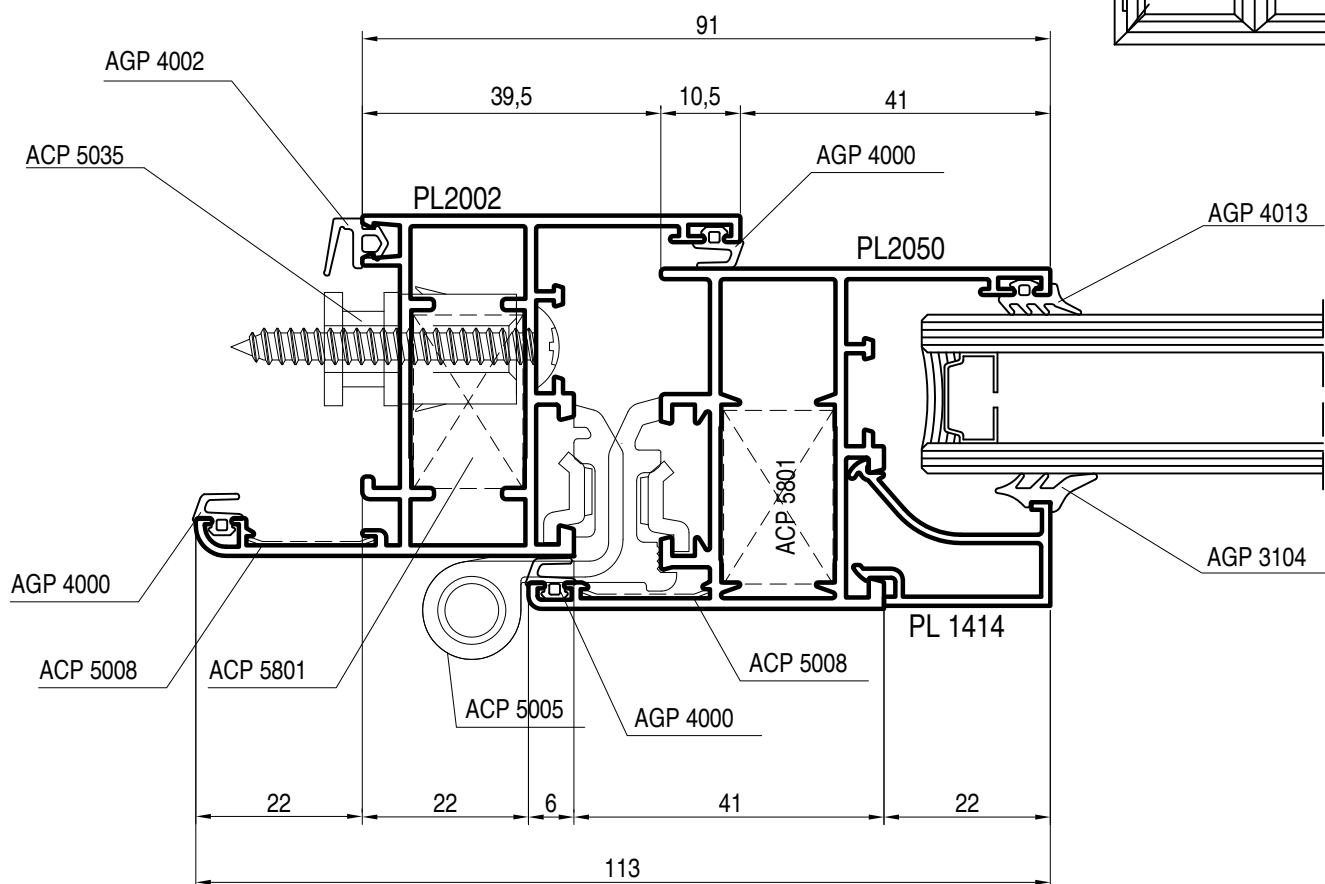

apertura interna - battente - nodo laterale

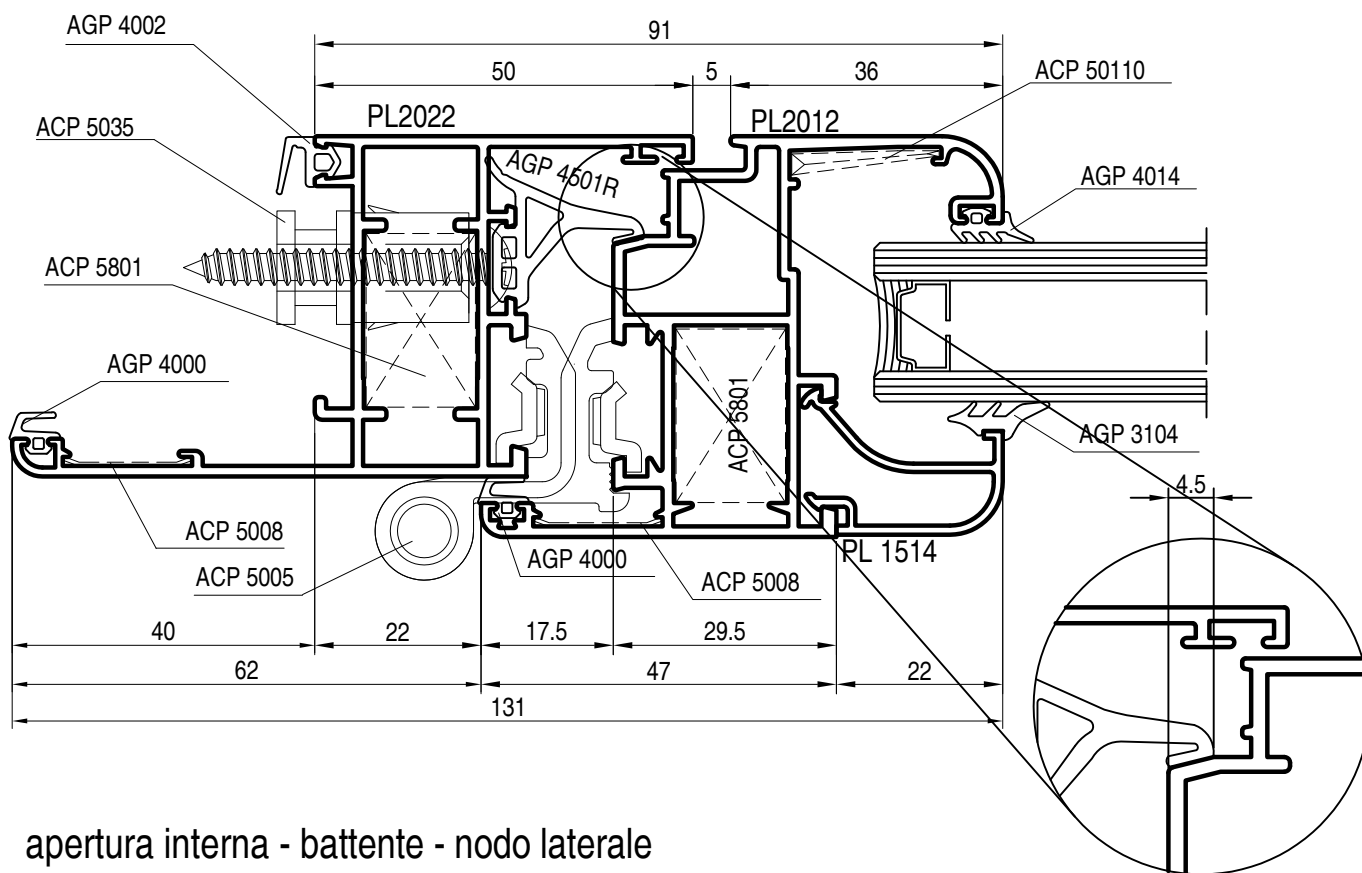

apertura interna - battente - nodo laterale

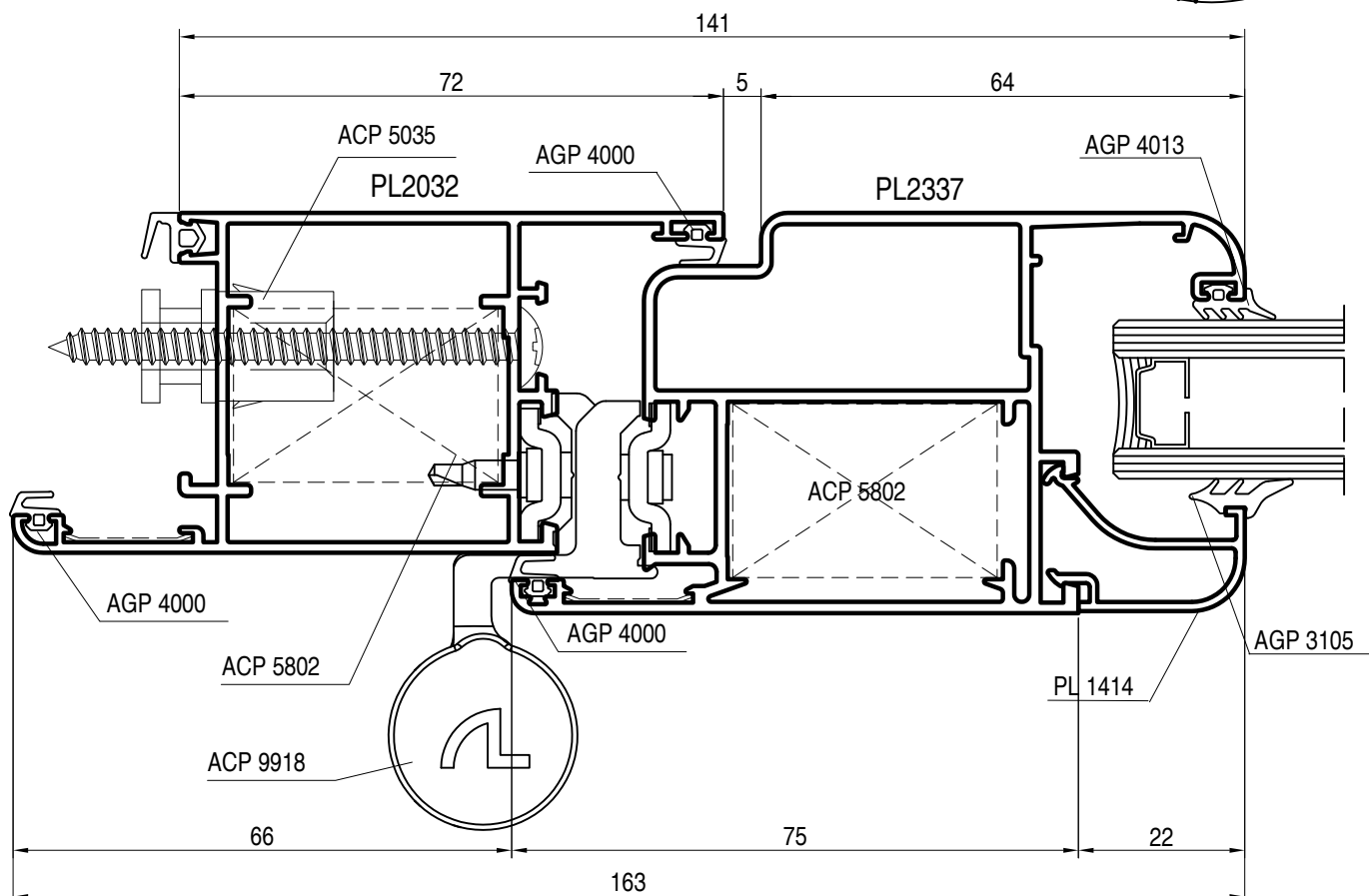

apertura interna - battente - nodo laterale

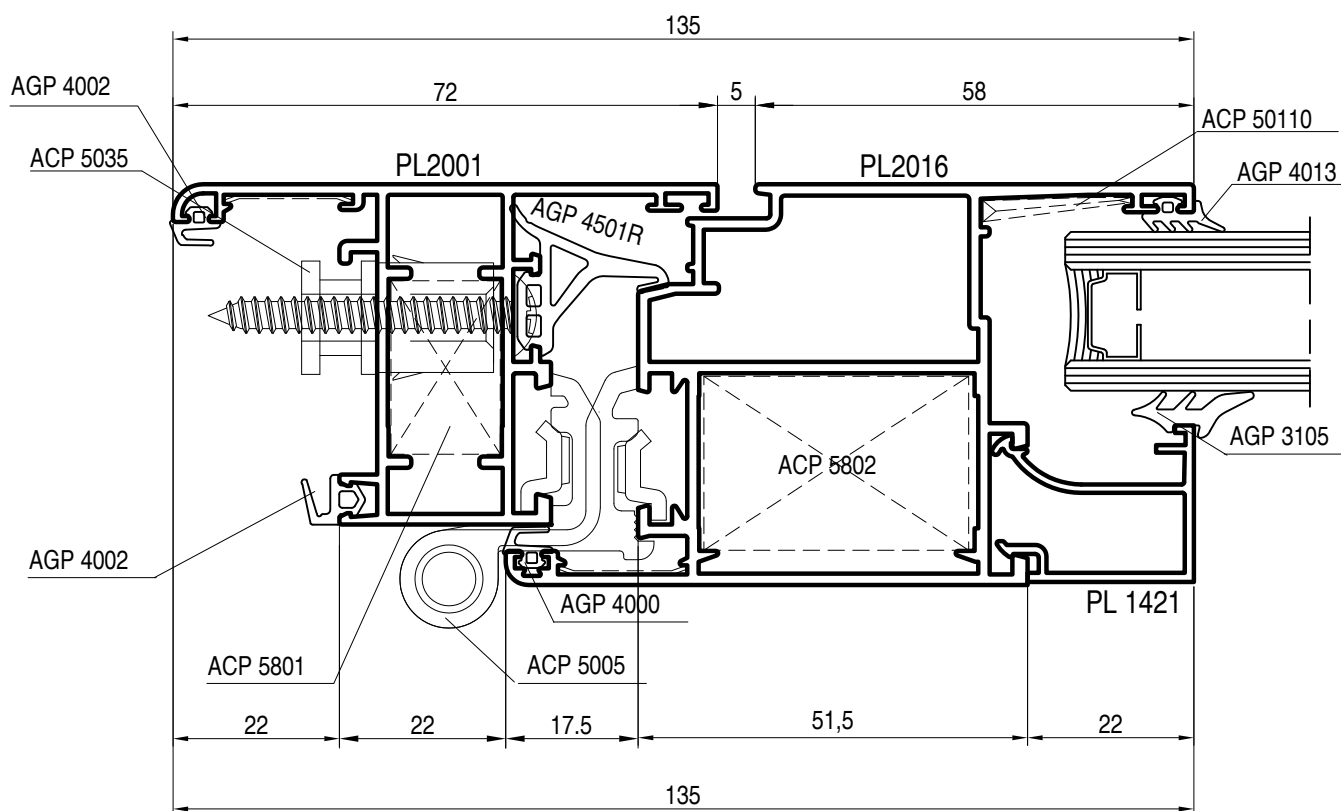

apertura interna - battente - nodo laterale

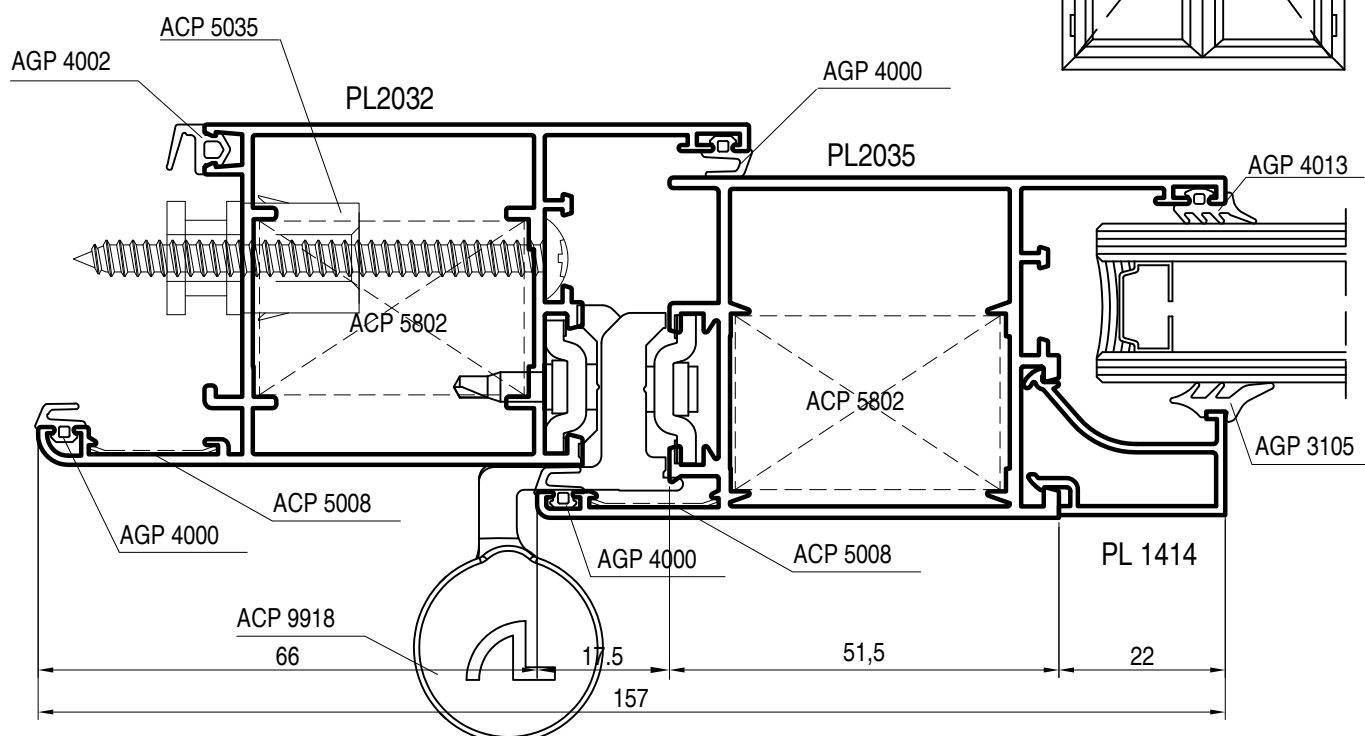
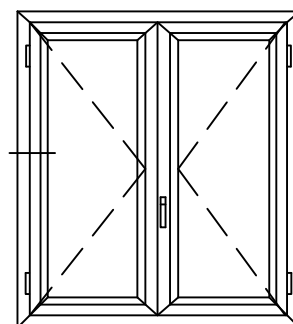

apertura interna - battente - nodo laterale

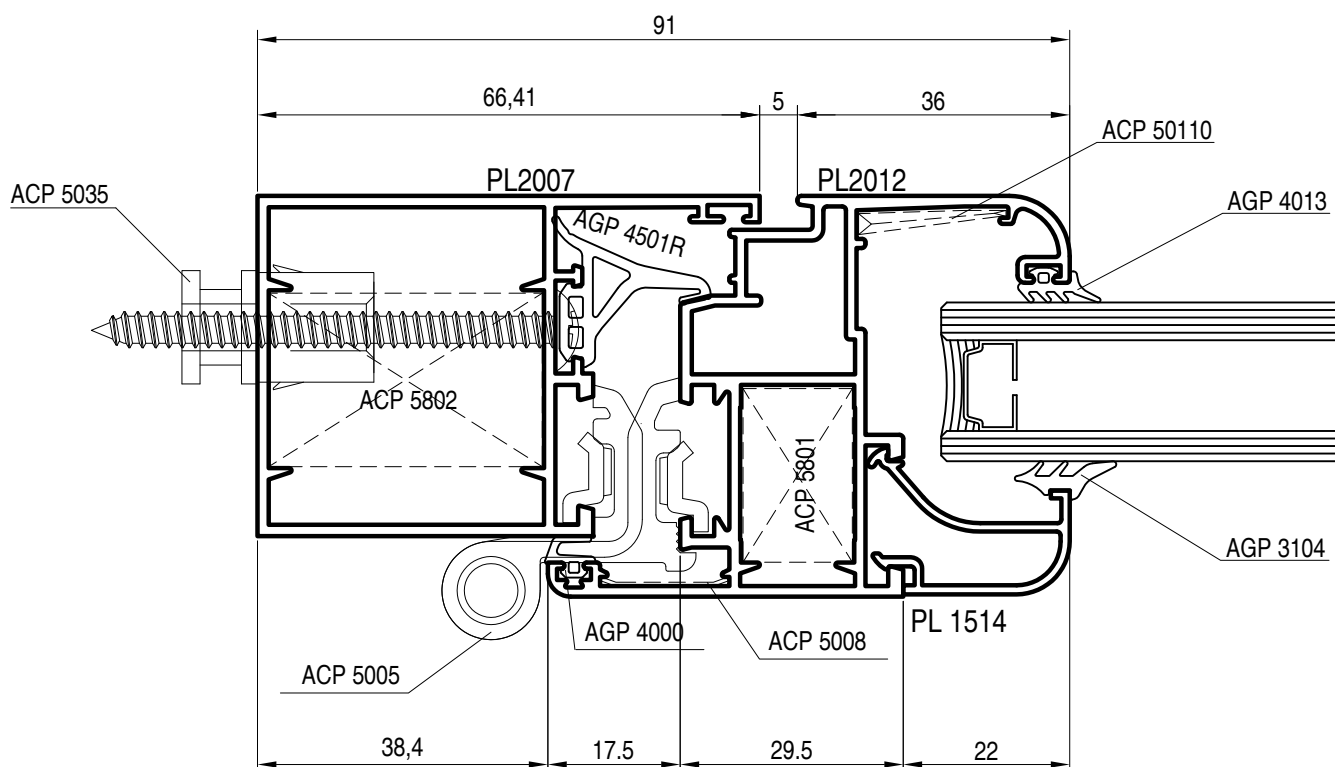

apertura interna - battente - nodo laterale

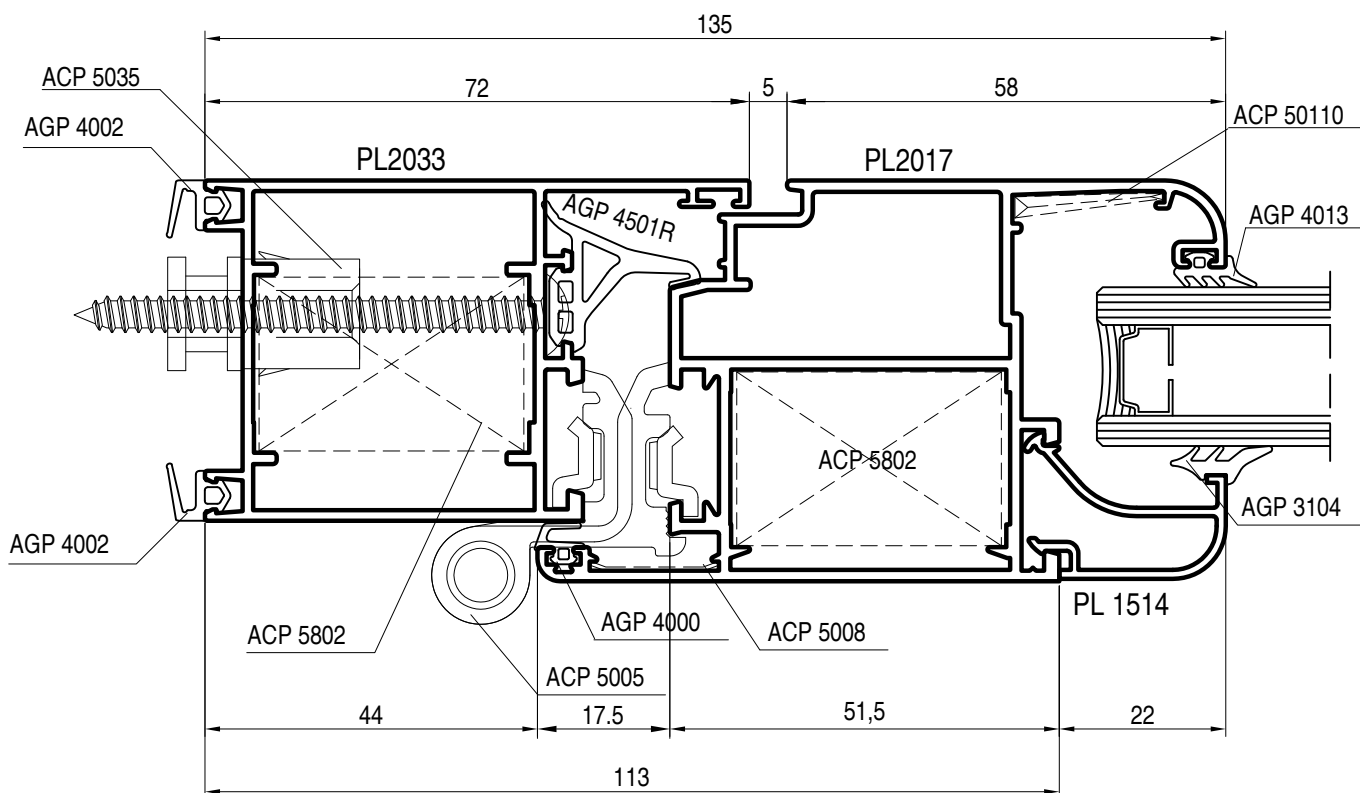

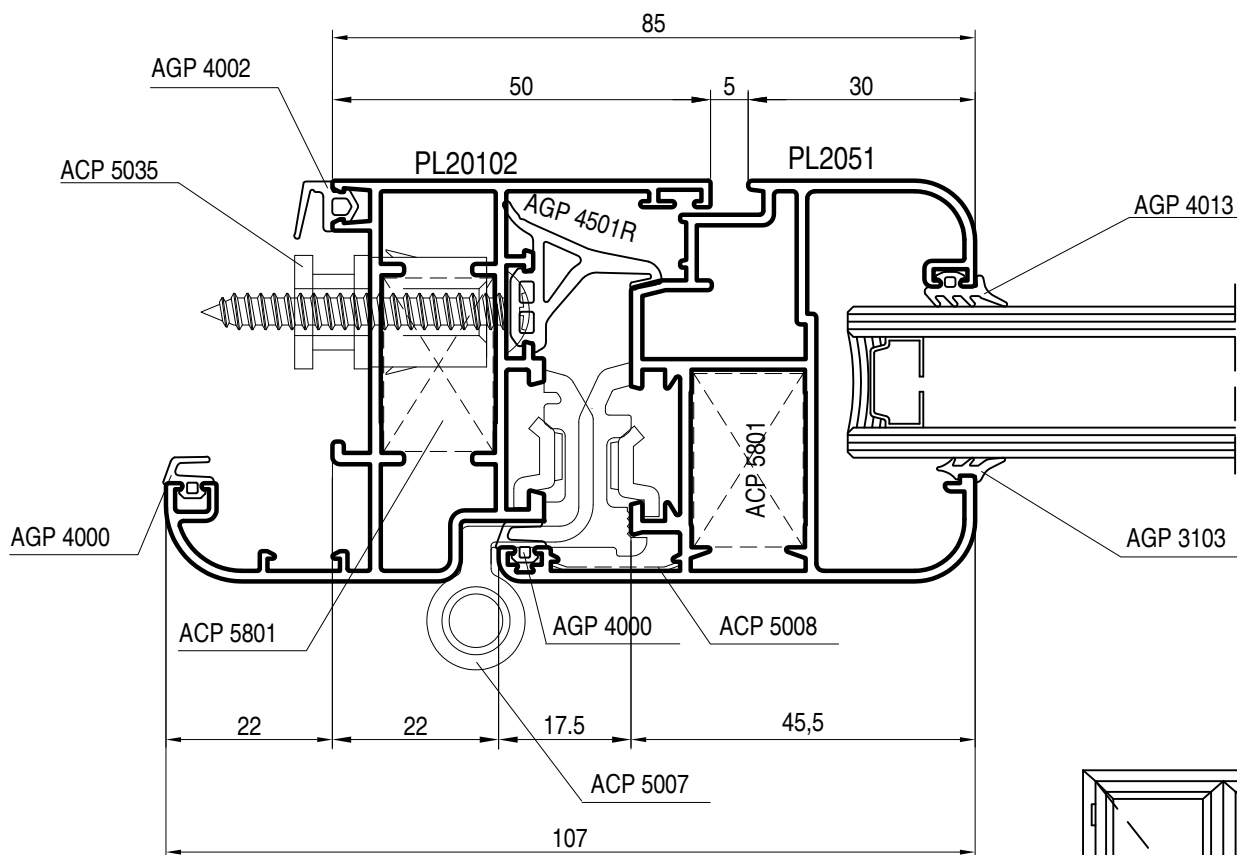

apertura interna - battente - nodo laterale

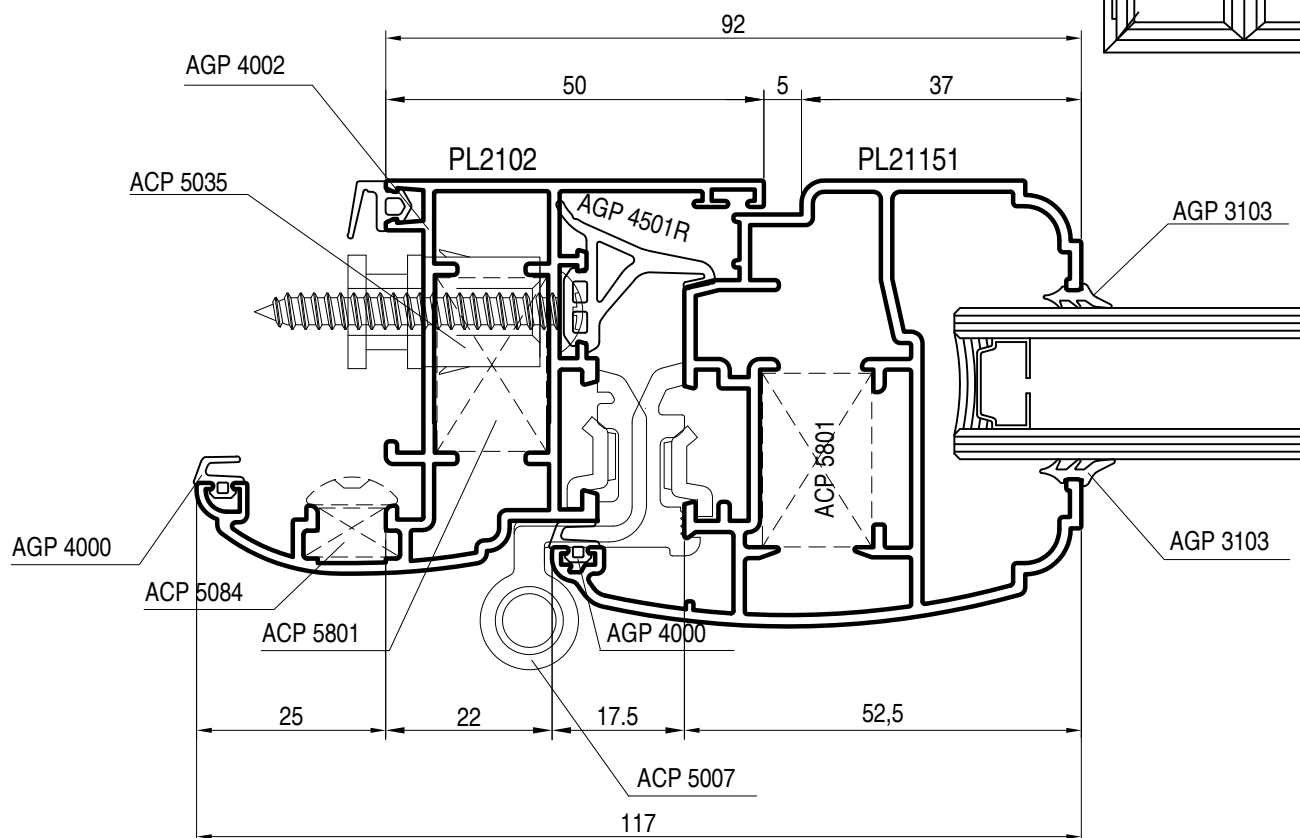
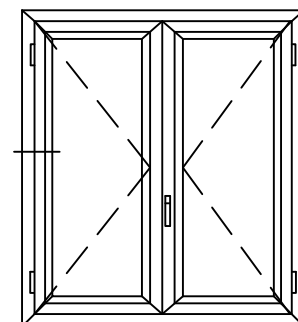

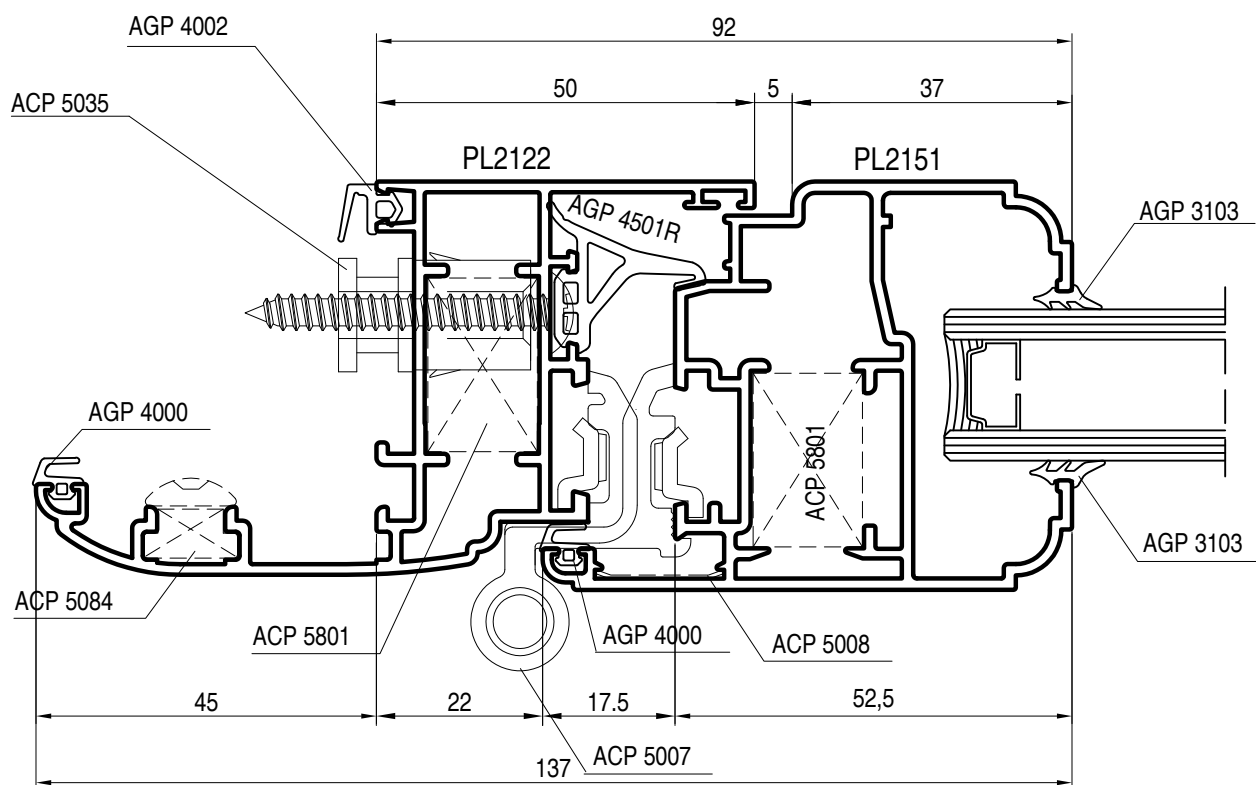

apertura interna - battente - nodo laterale

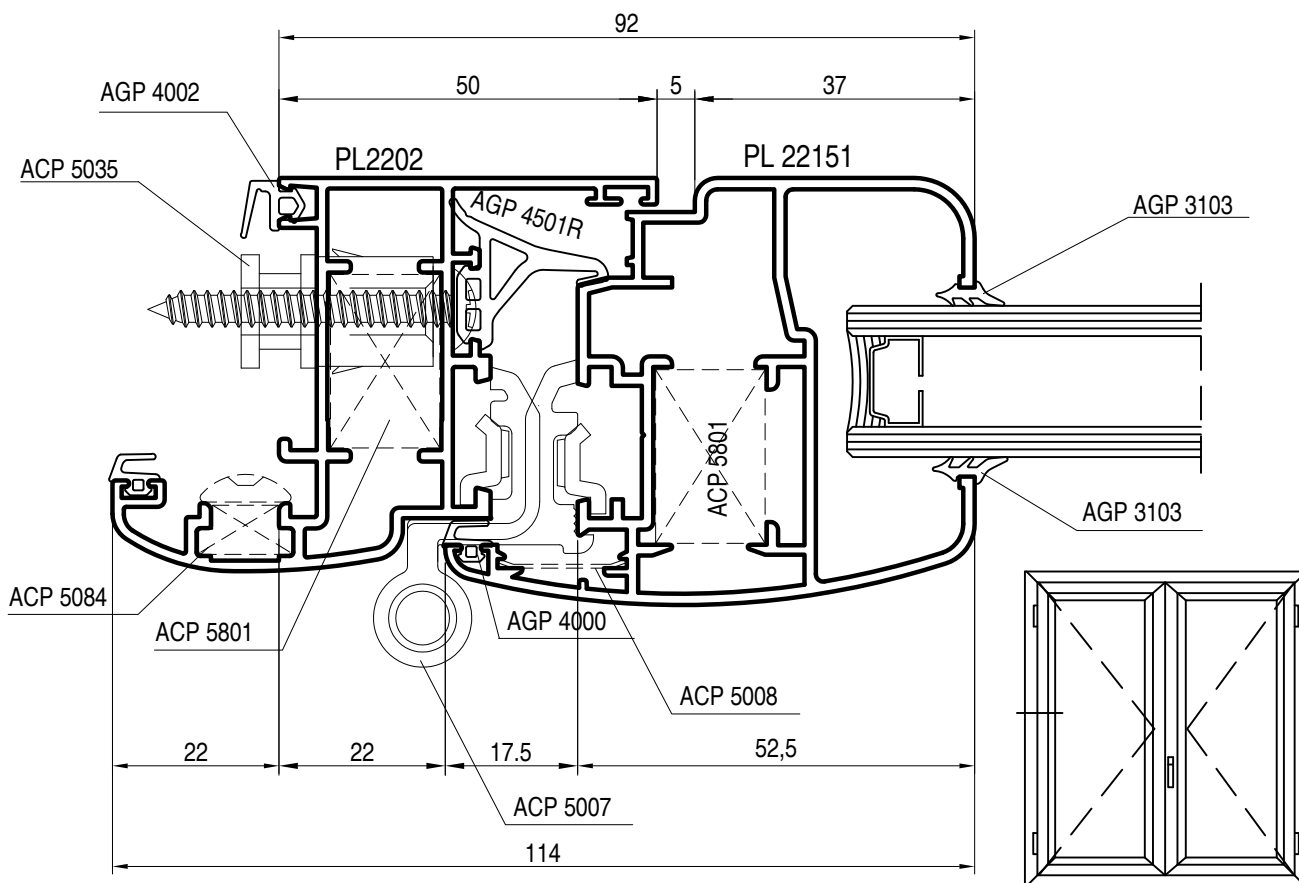

apertura interna - battente - telaio con scalino

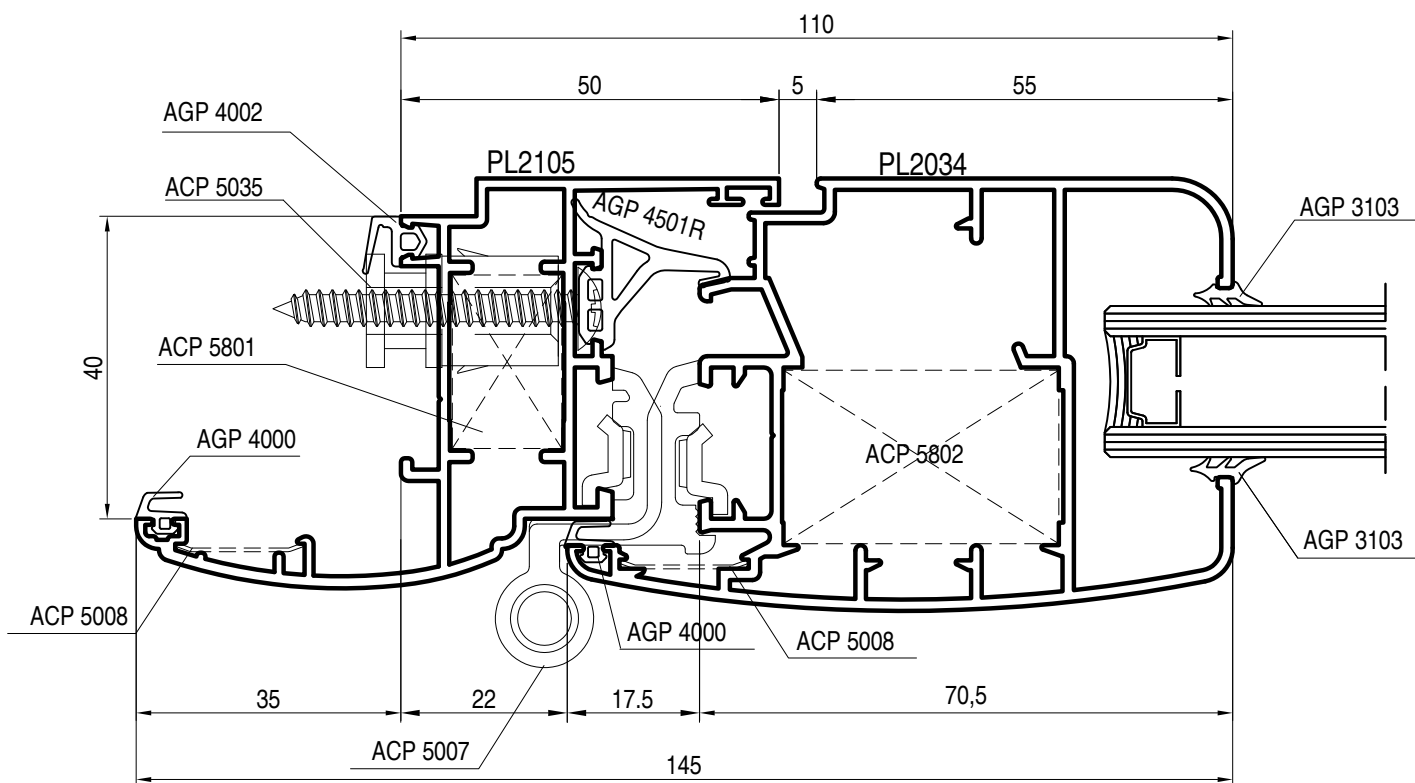
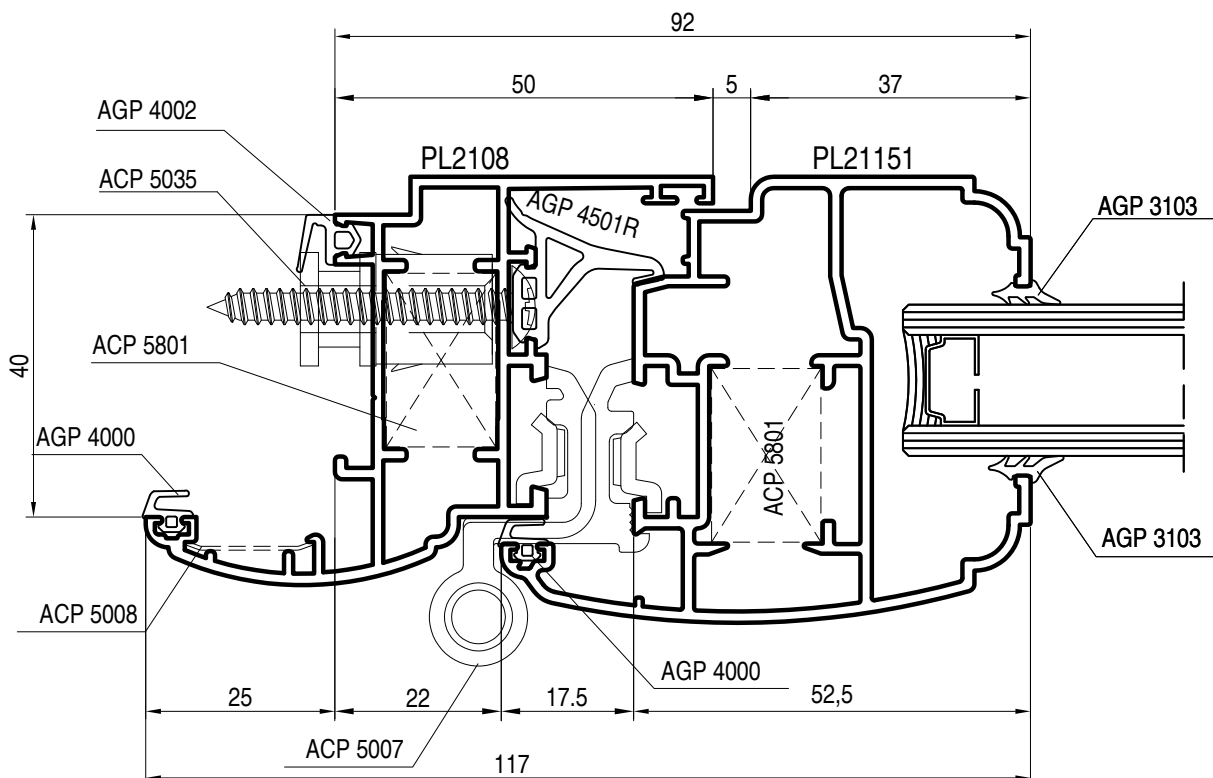

apertura interna - battente - nodo laterale

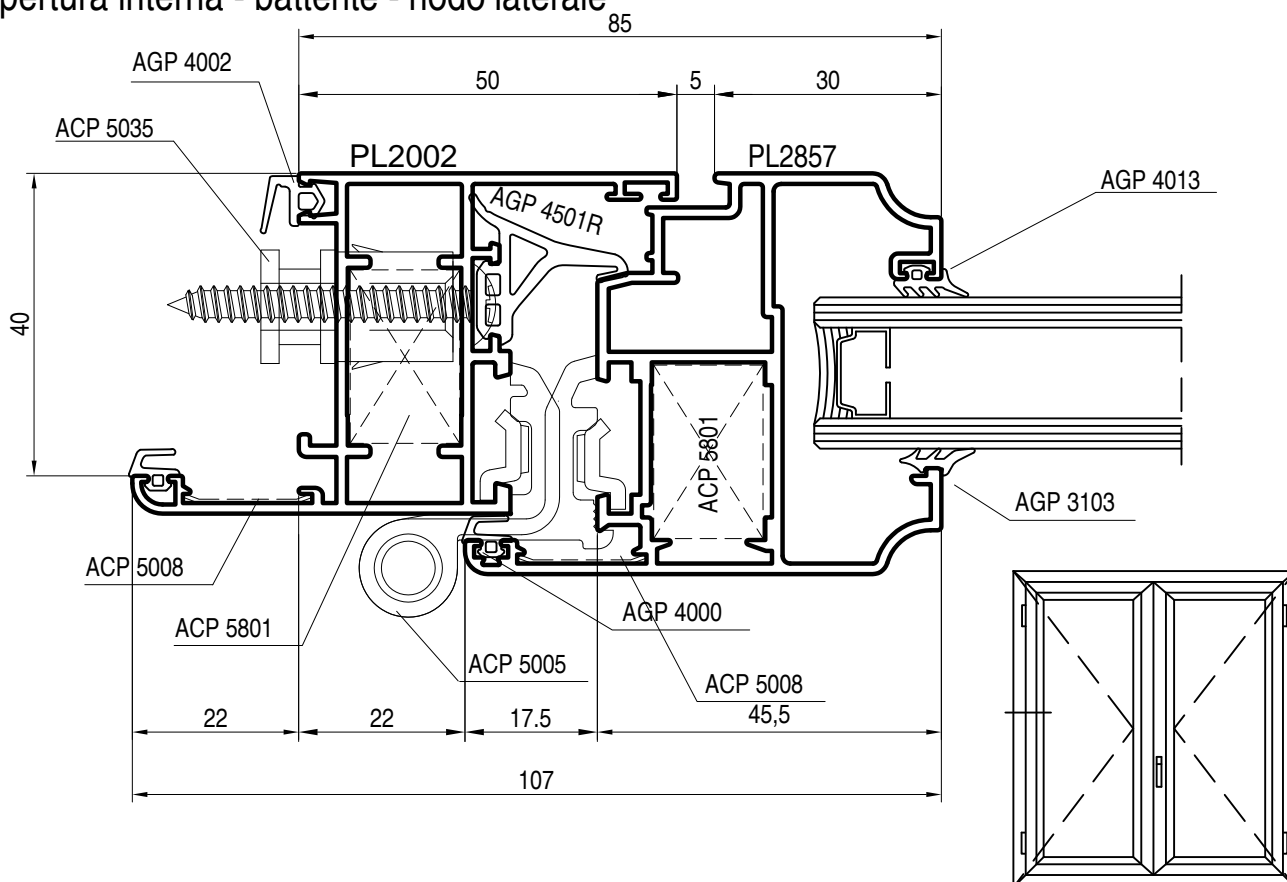

apertura esterna - battente - nodo laterale

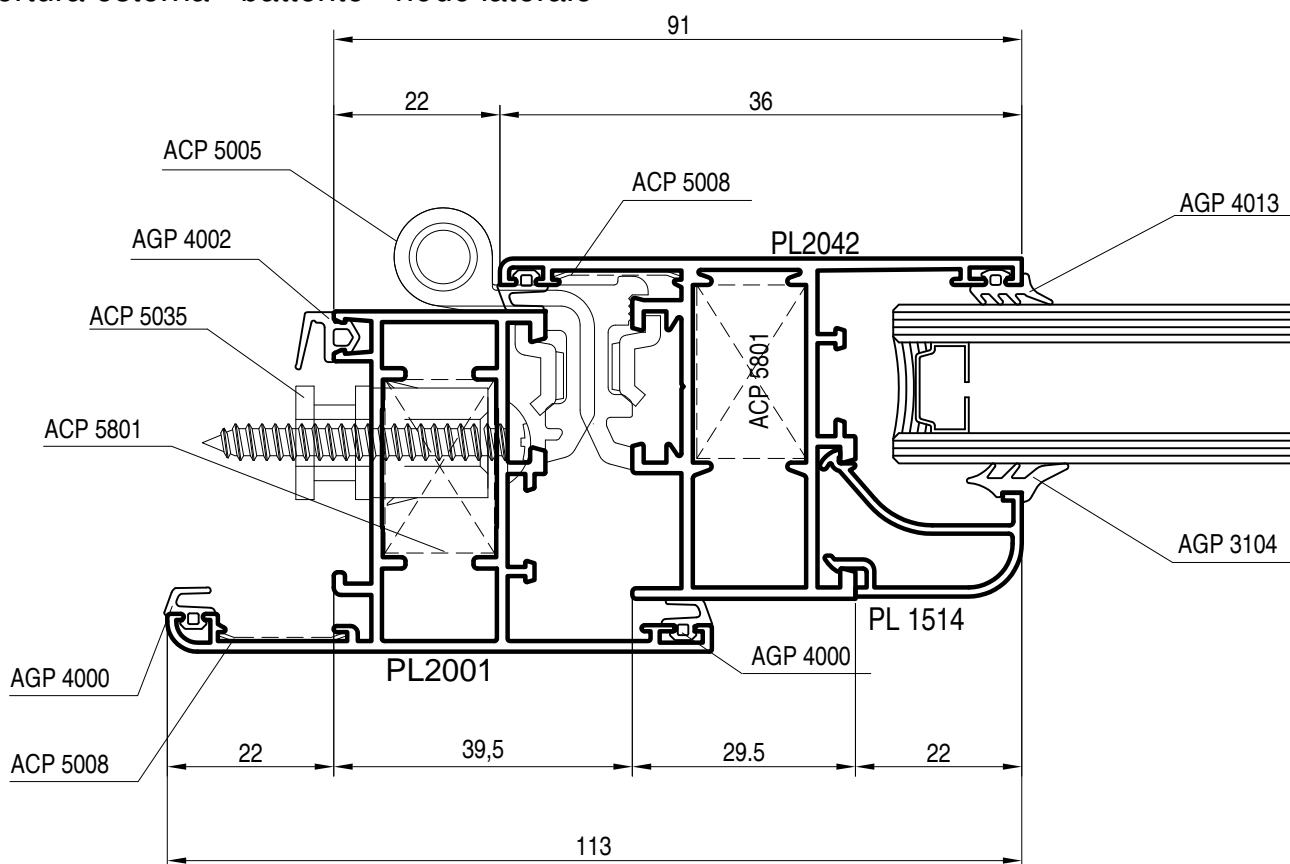

apertura esterna - porta - nodo laterale

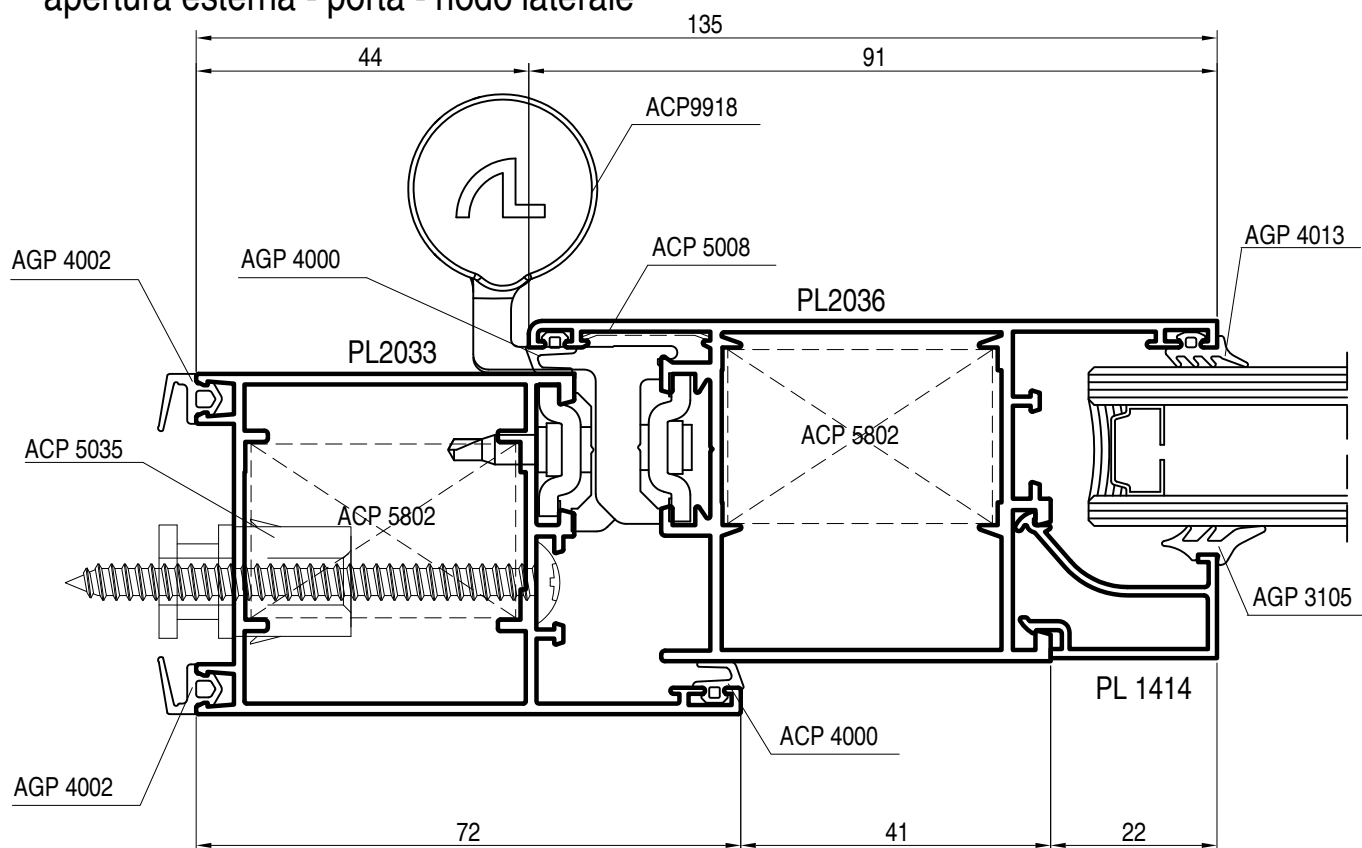

apertura sporgere - nodo laterale

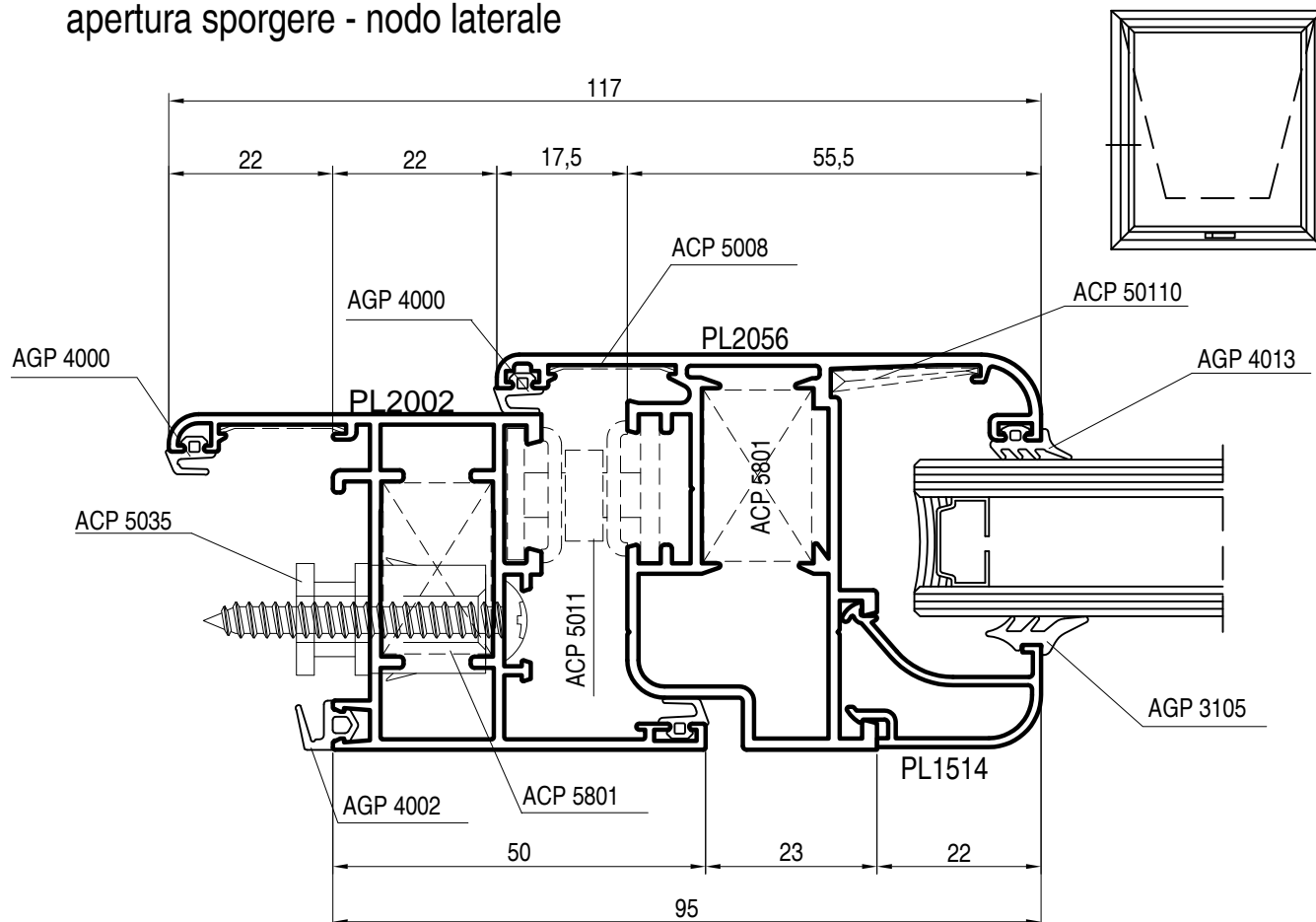

tipologia con oscurante integrato - finestra a battente - nodo con guida

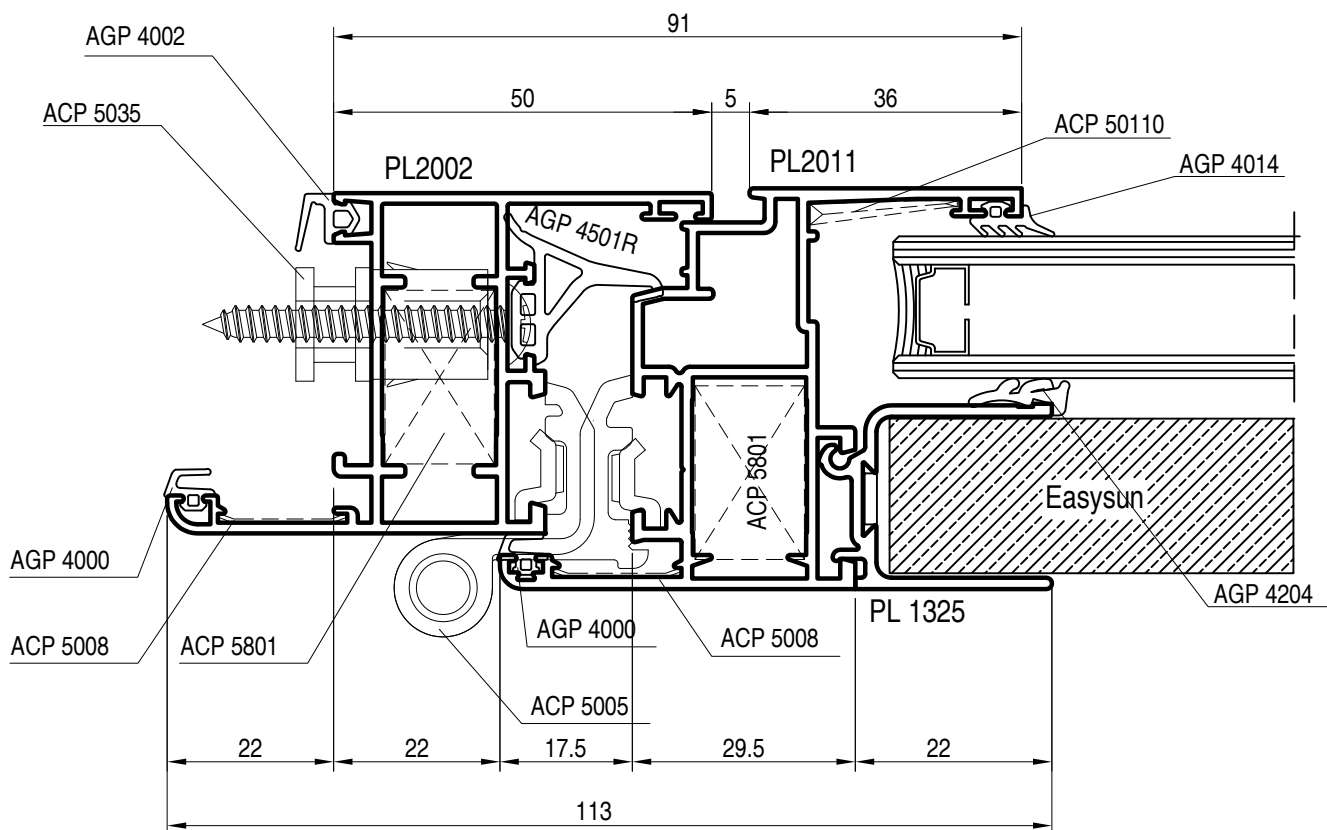

tipologia con oscurante integrato - finestra a battente - nodo con fermavetro

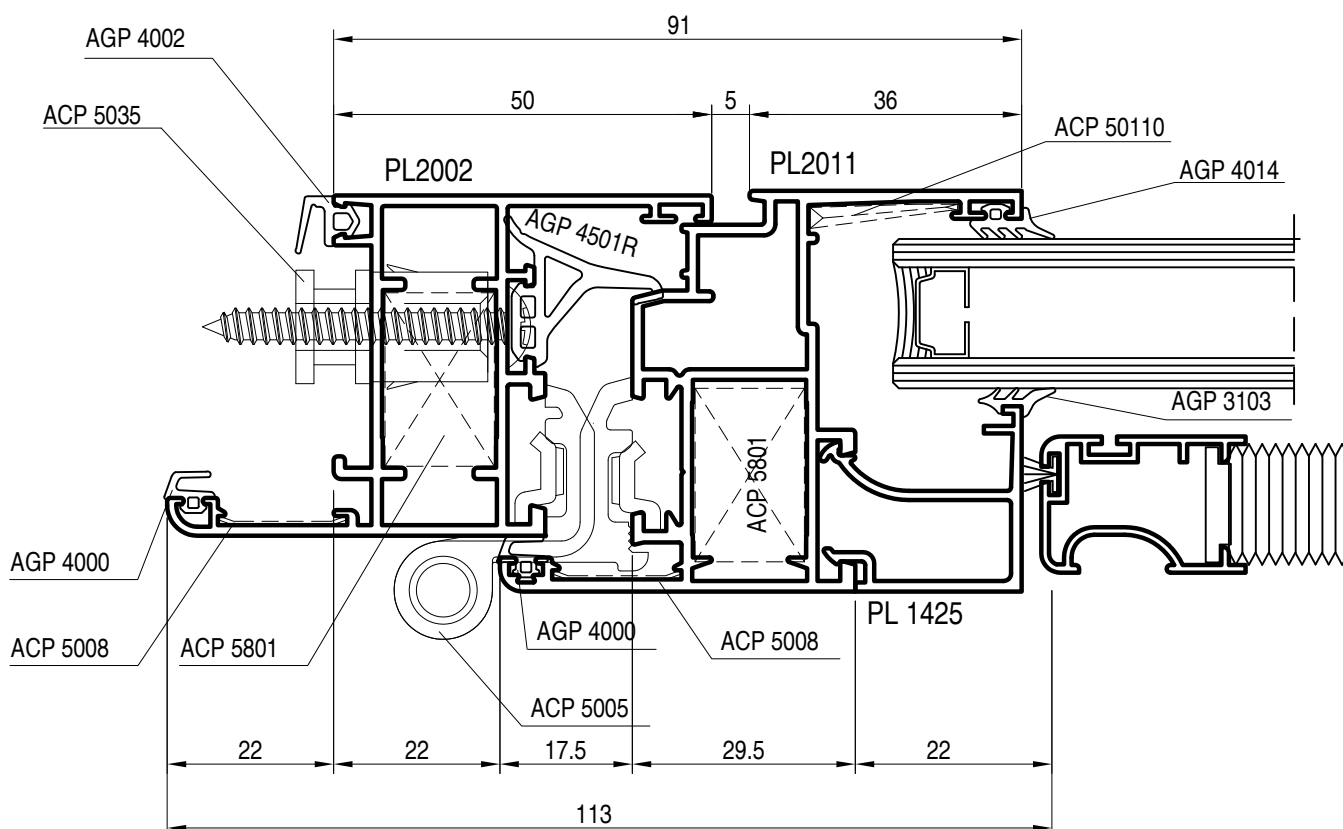

apertura interna - battente con scureto - nodo laterale

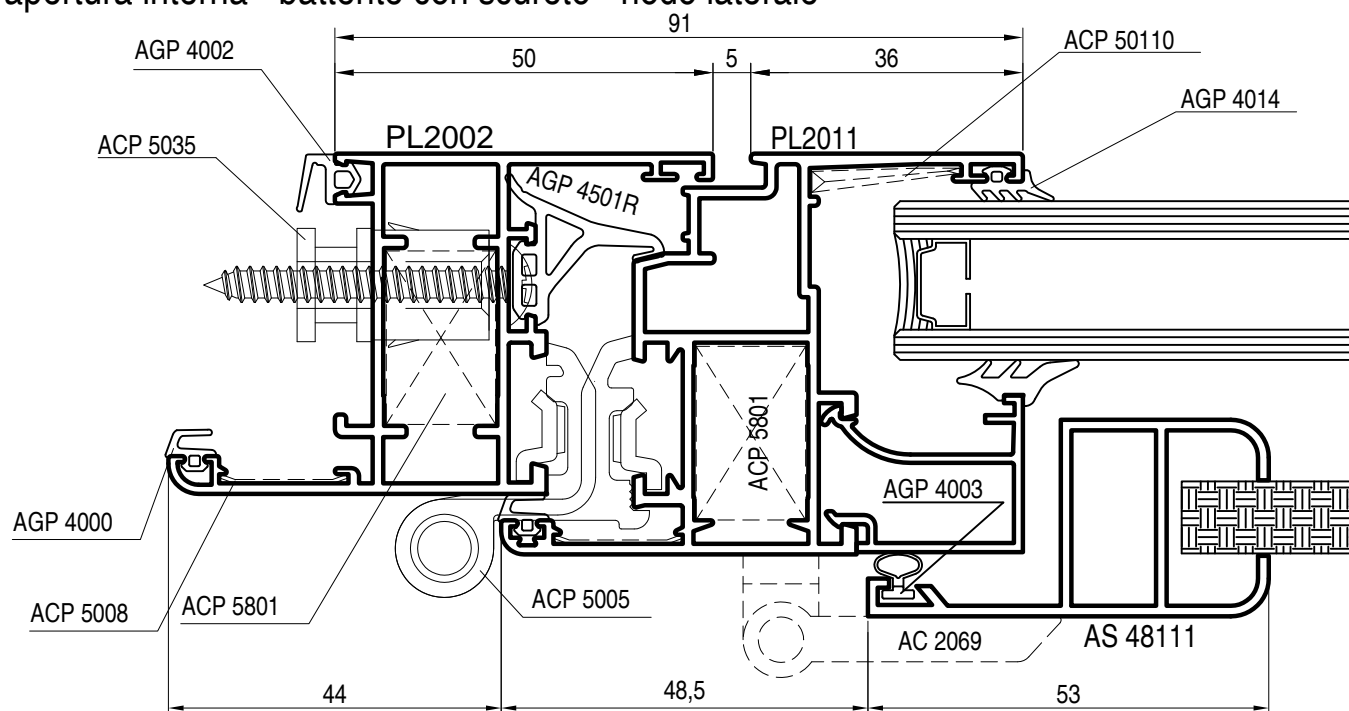

nodo laterale abbinamento Slide 60

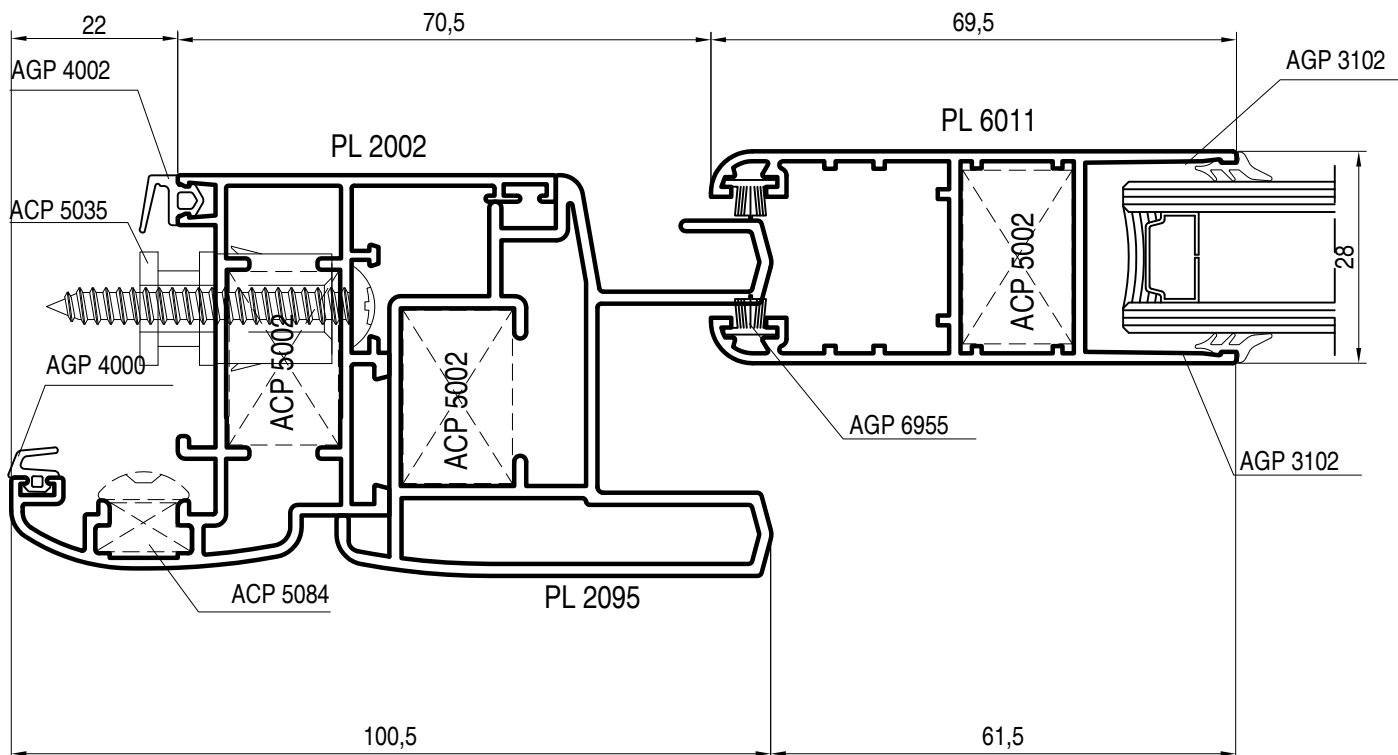

apertura esterna - battente + fisso - nodo laterale

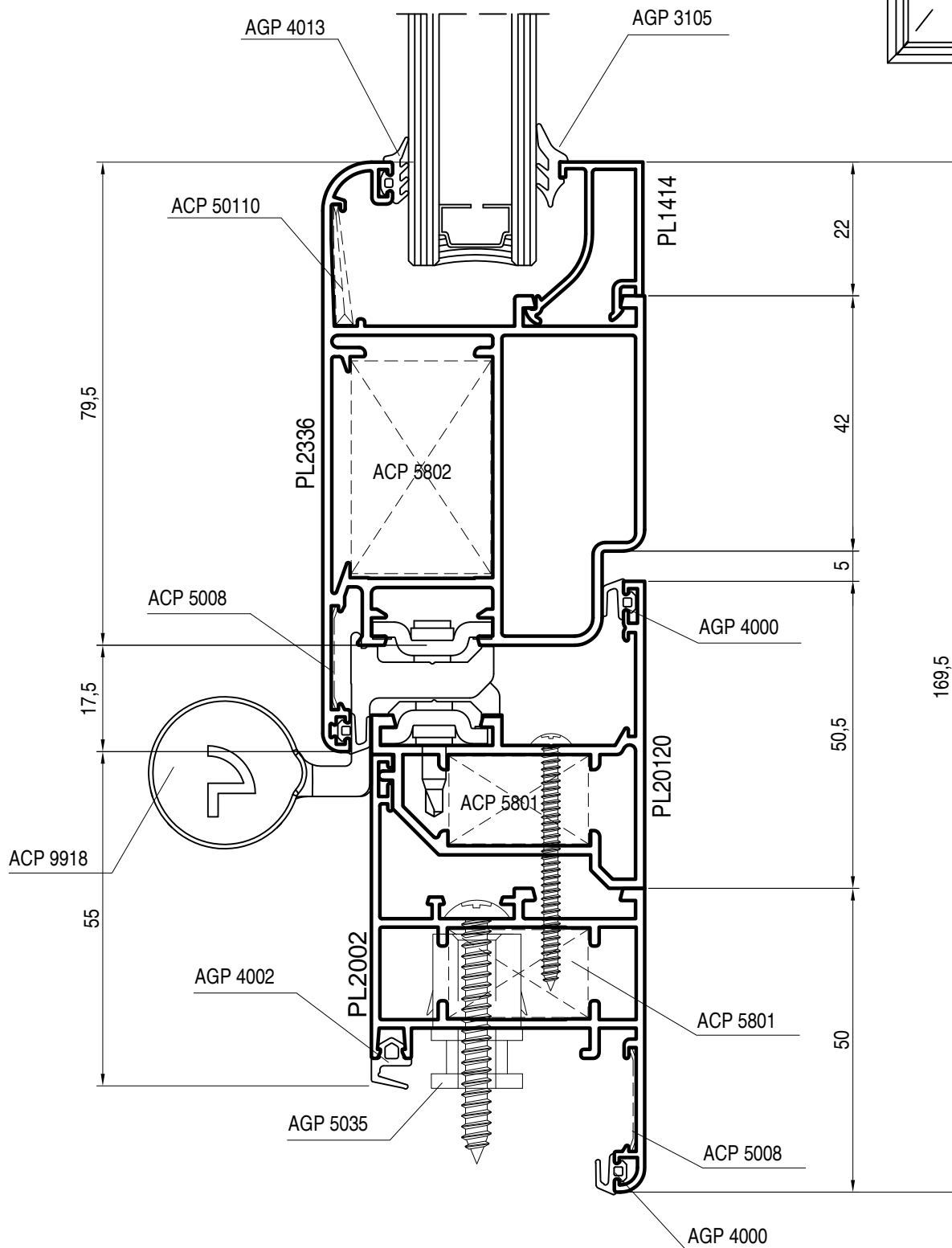
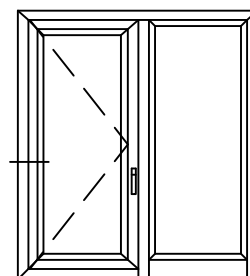

bilico - nodo perimetrale inferiore

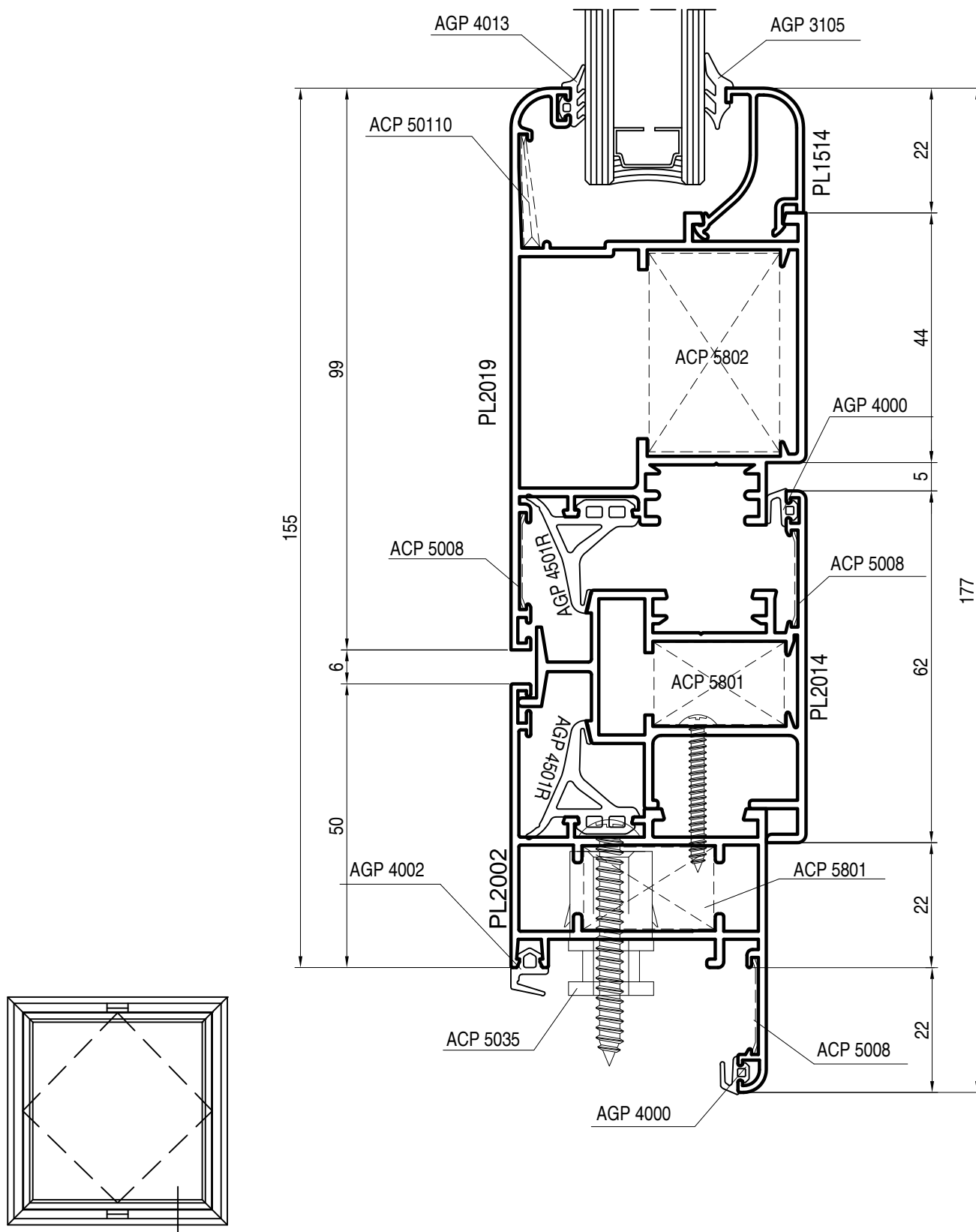

bilico - nodo perimetrale superiore

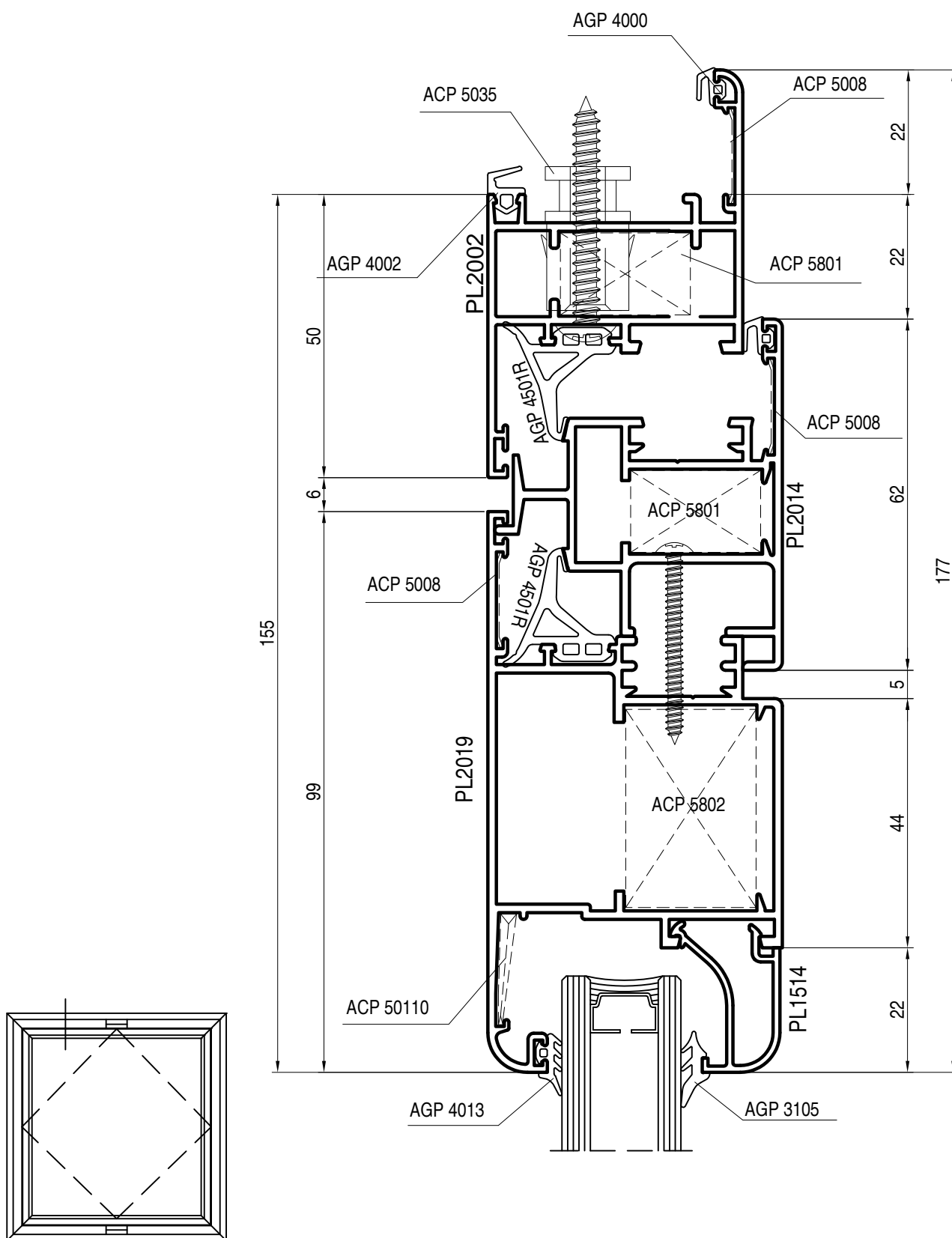

apertura interna - battente - nodo centrale

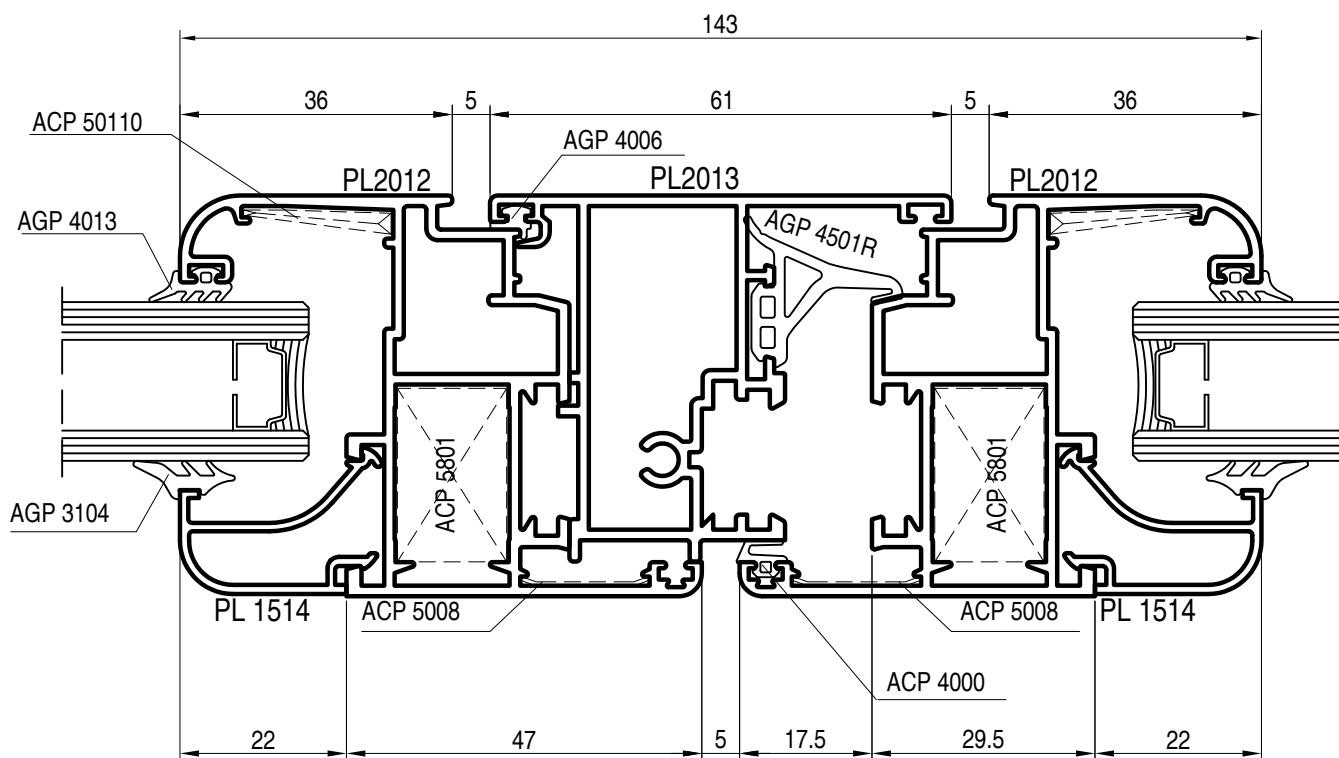

apertura interna - battente - nodo centrale

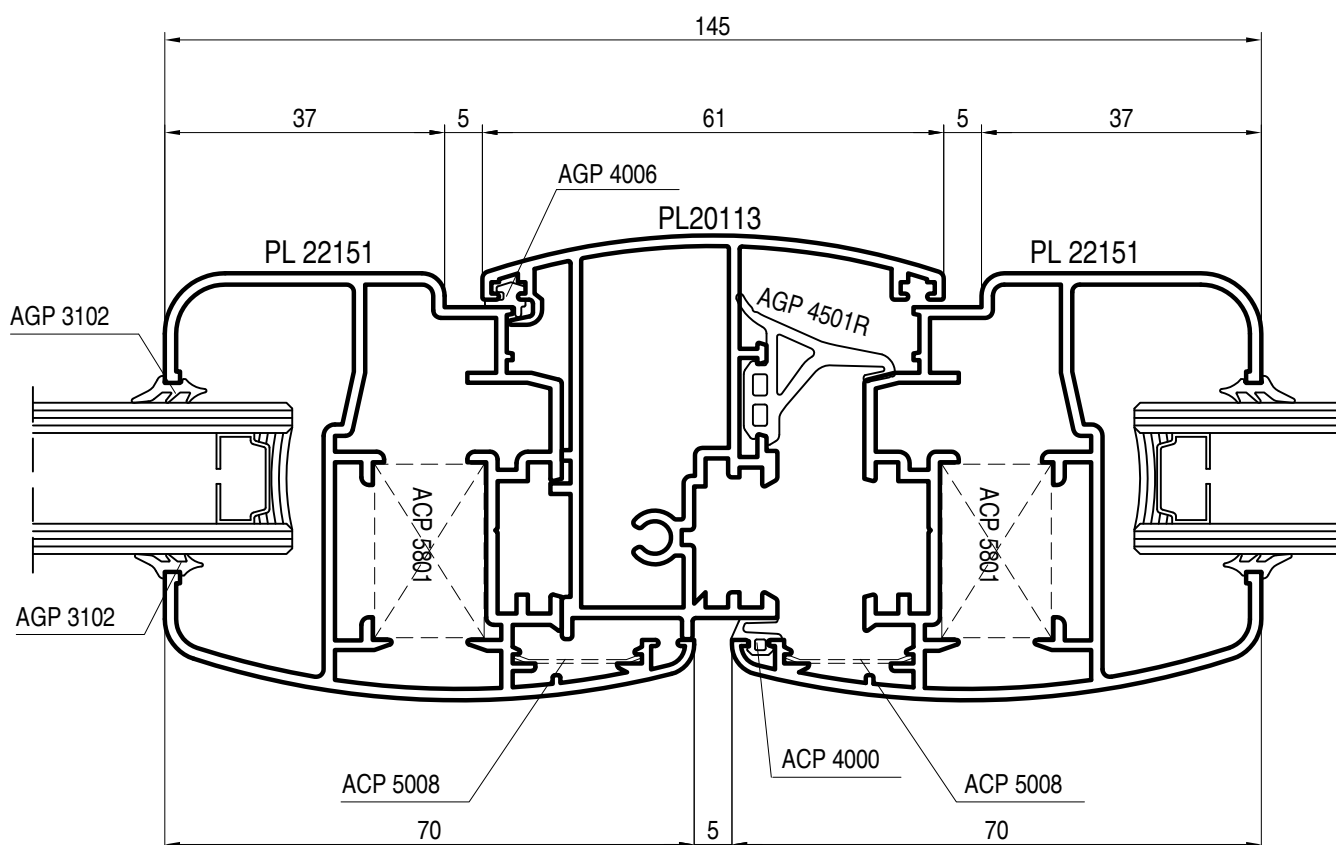

apertura esterna - porta - nodo centrale

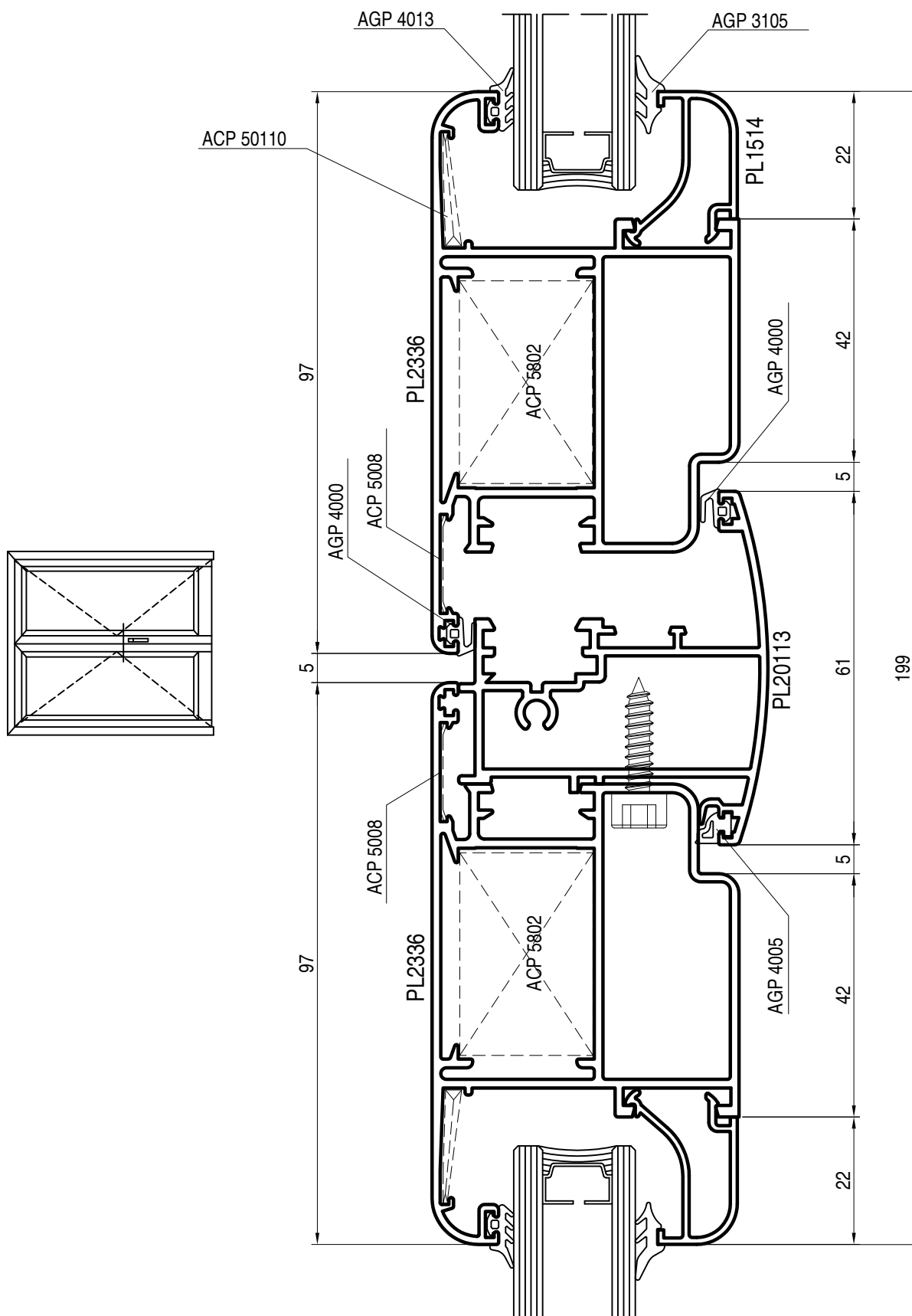

apertura interna - battente 3 ante - nodo centrale

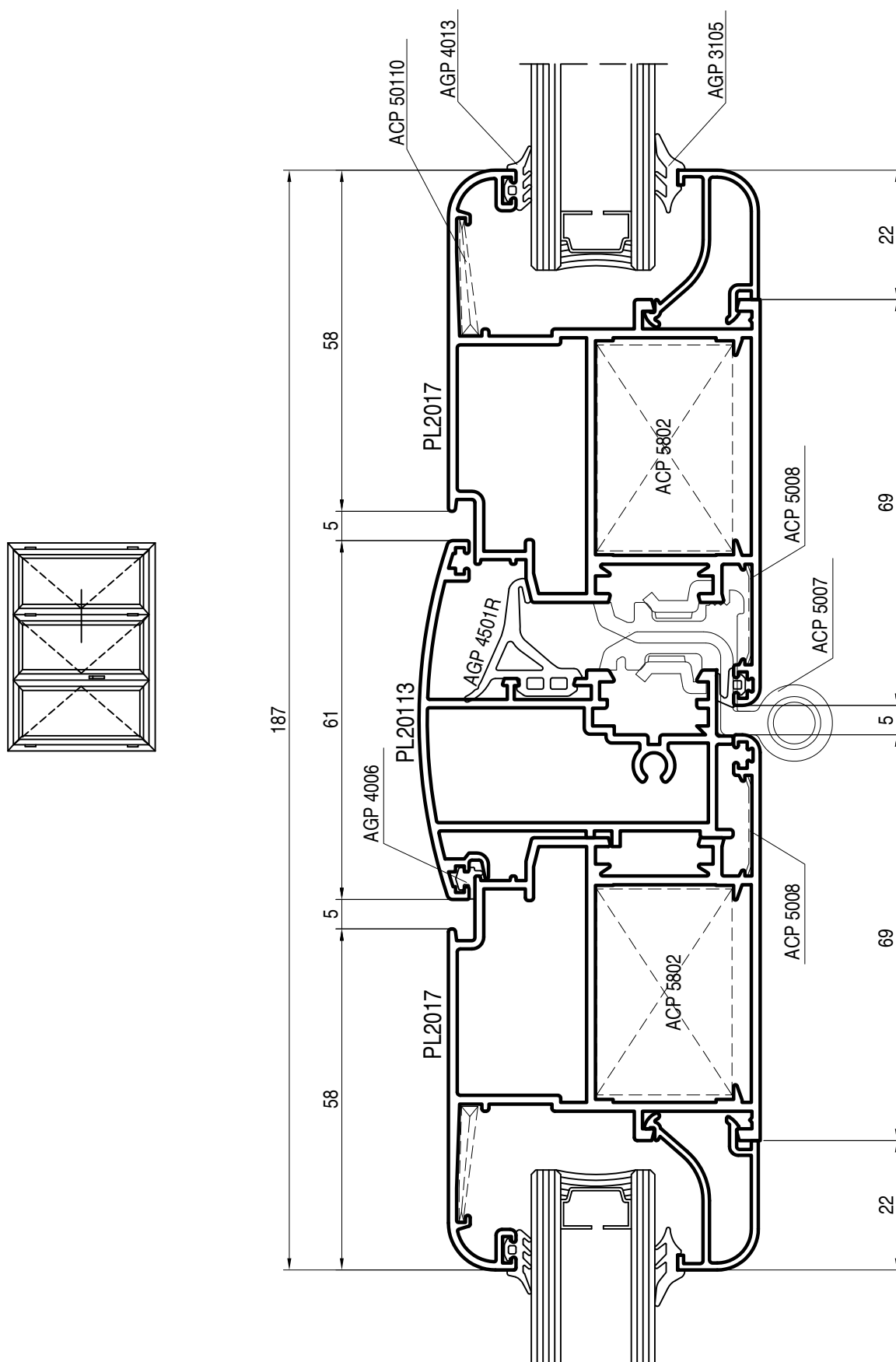

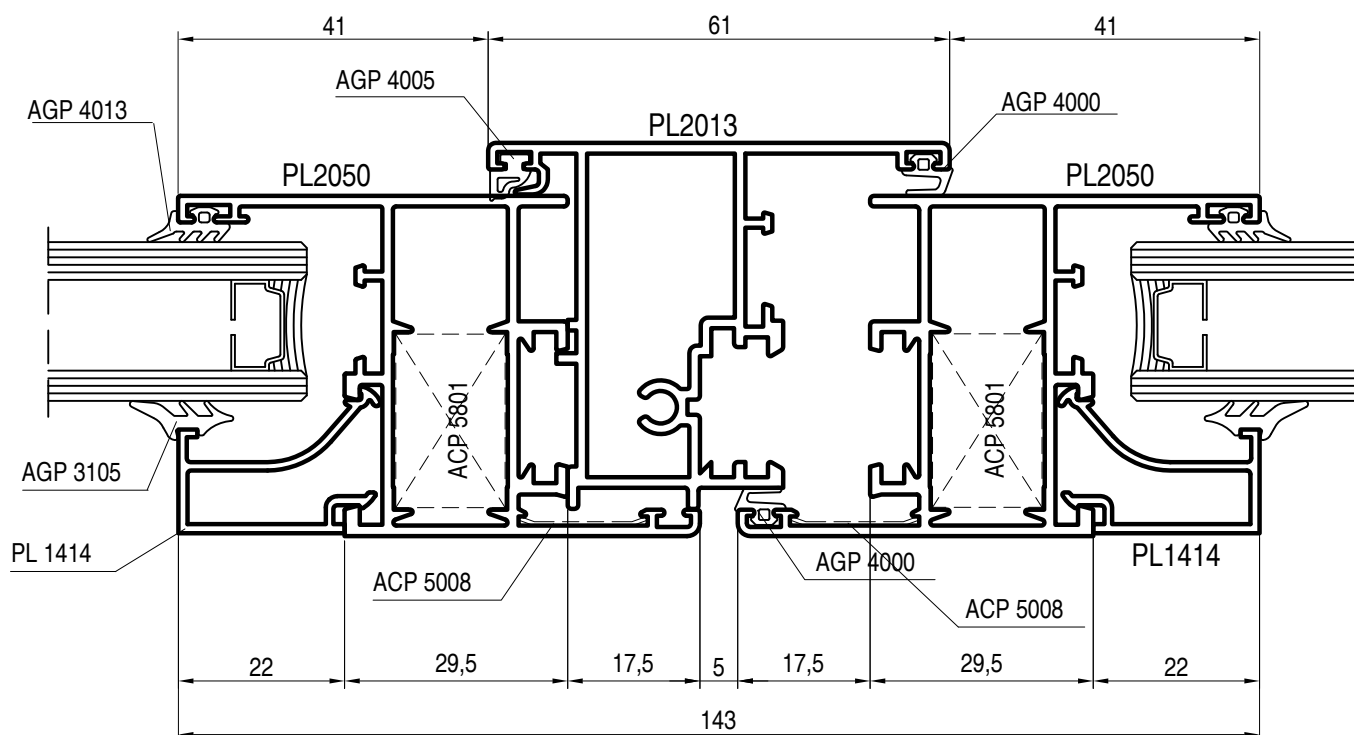

apertura interna - battente - nodo centrale

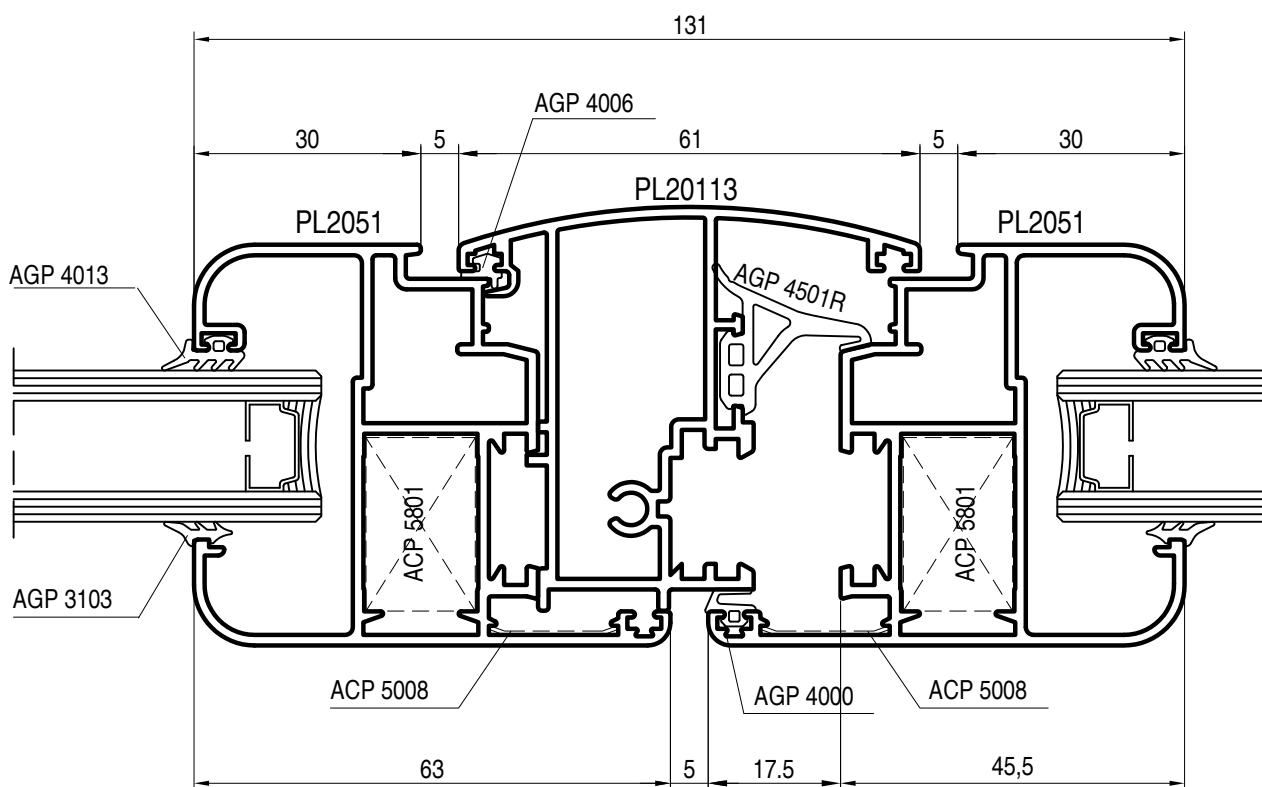

apertura interna - battente - nodo soglia calpestabile

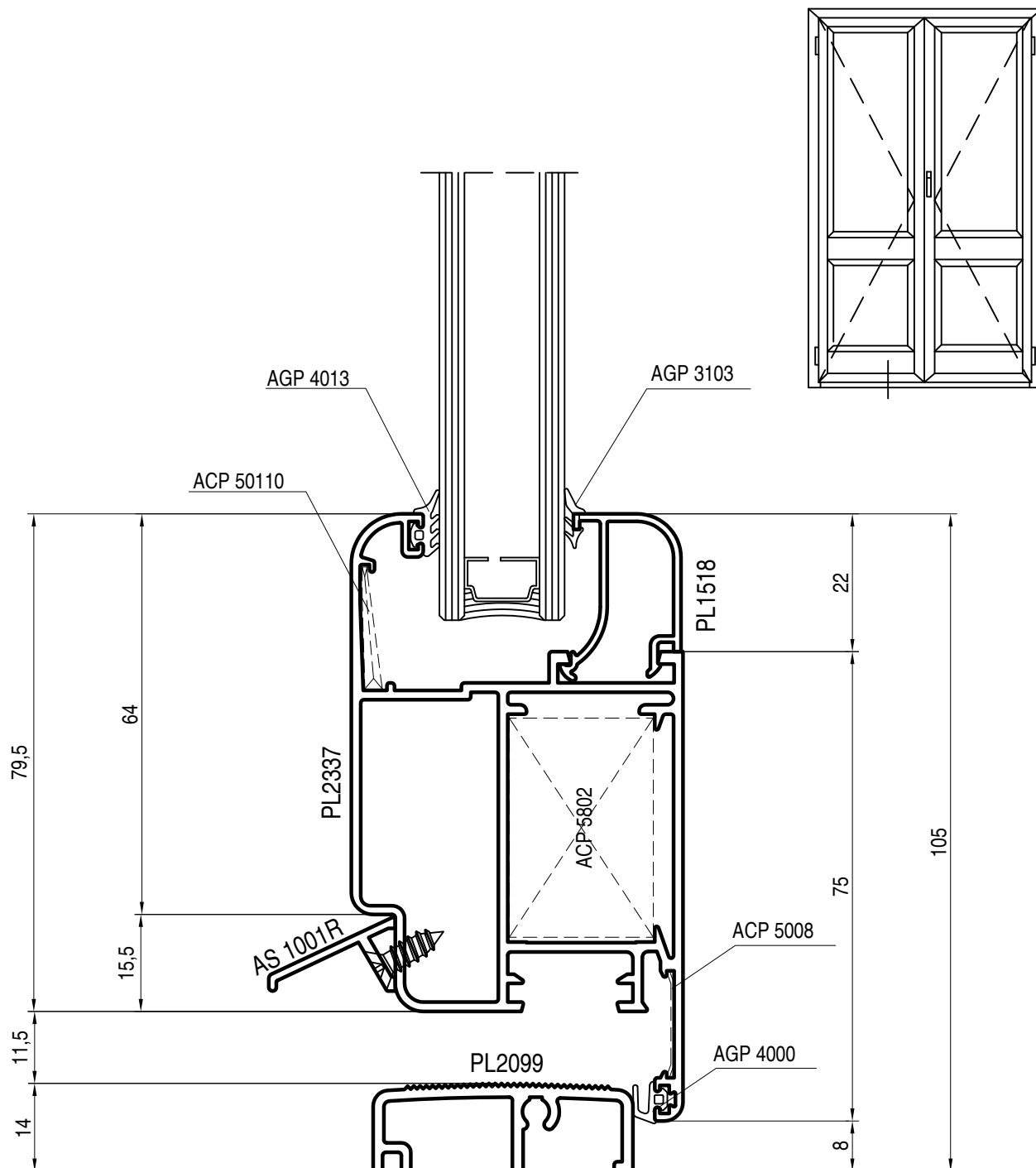

apertura interna - battente - nodo soglia ribassata

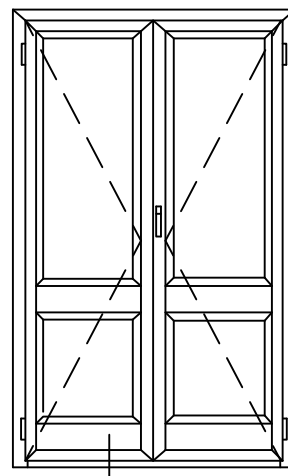
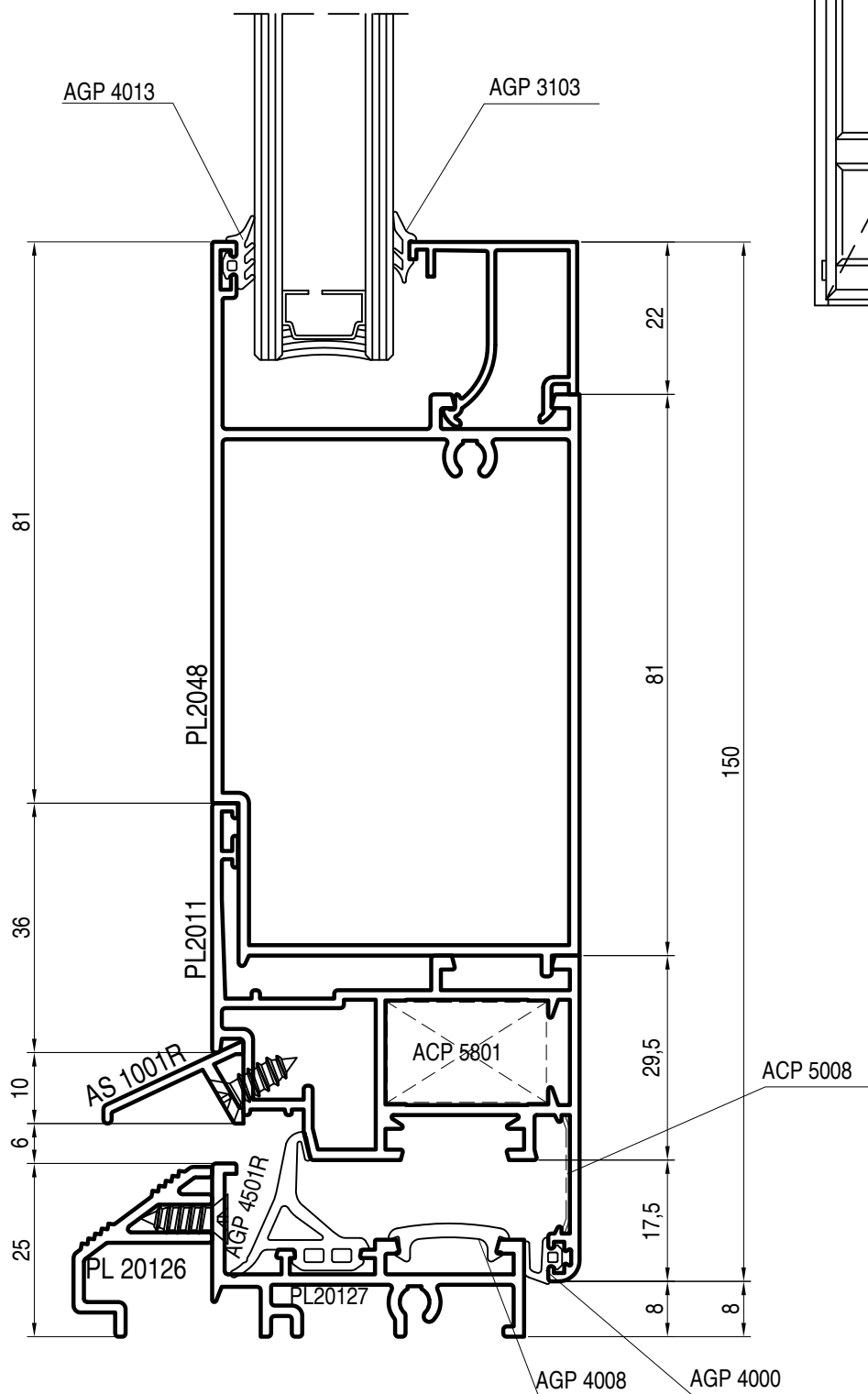

apertura interna - battente - nodo soglia

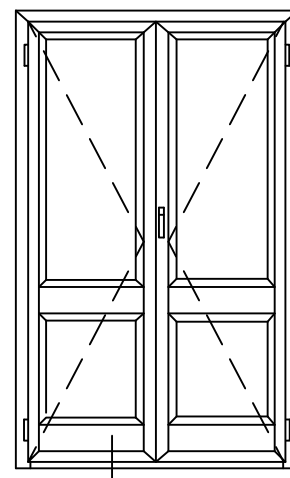
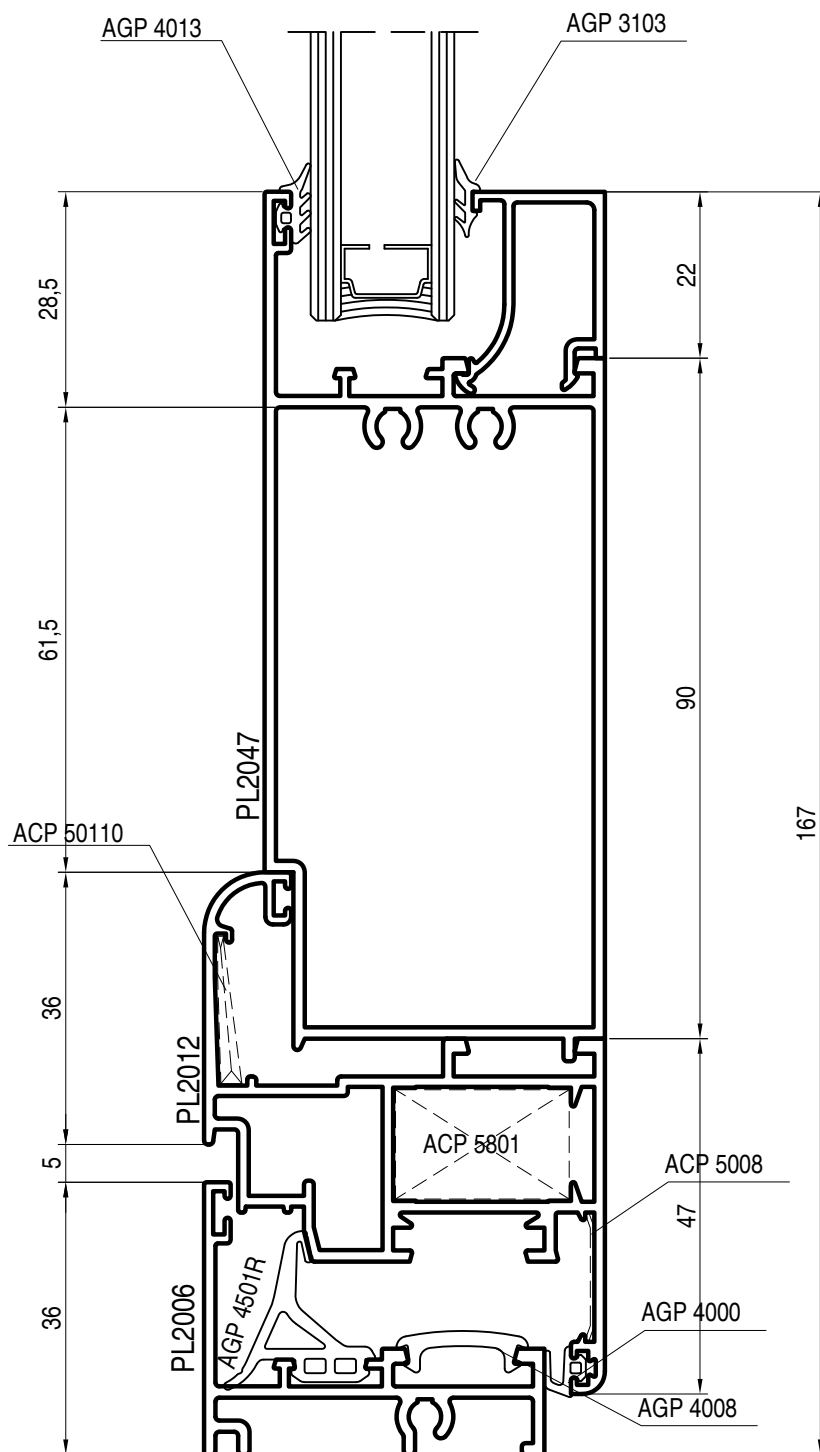

apertura interna - battente - nodo davanzale

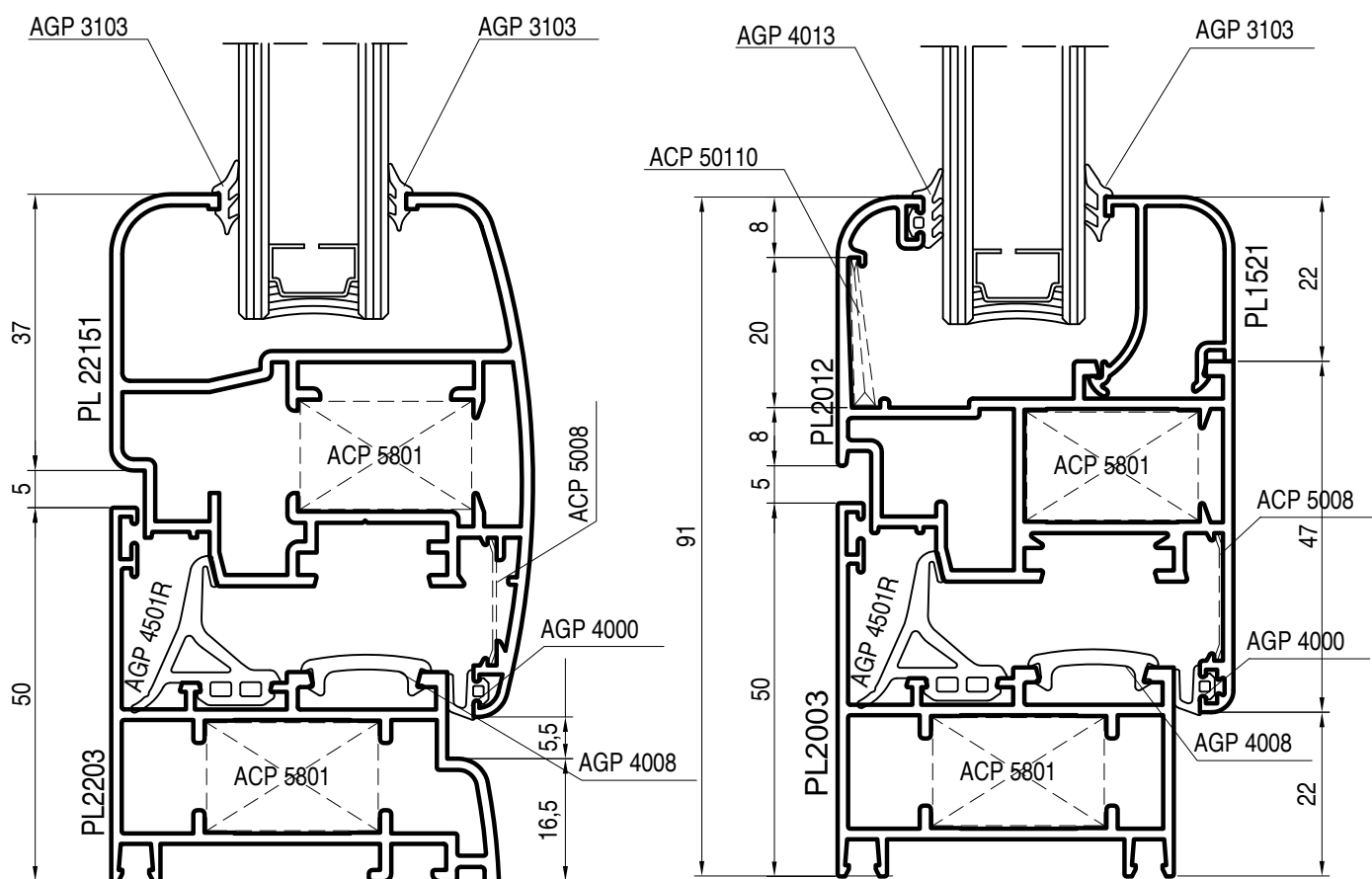
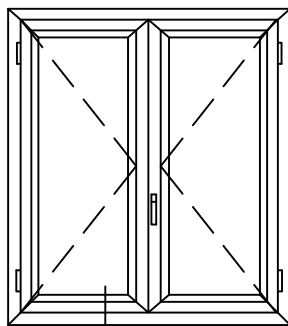

apertura Scopello - battente - persiana più finestra

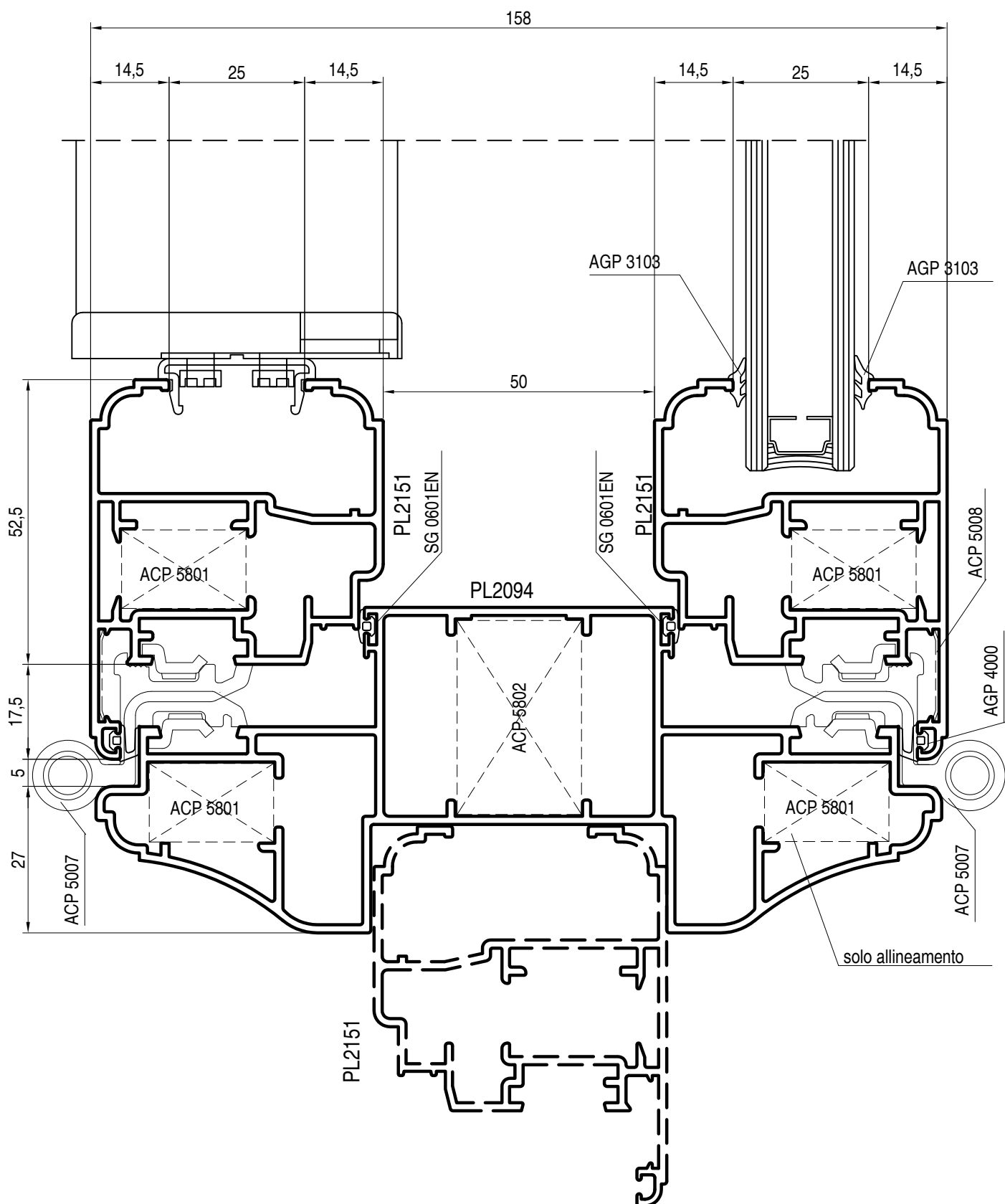

Doghe e profilo cornice

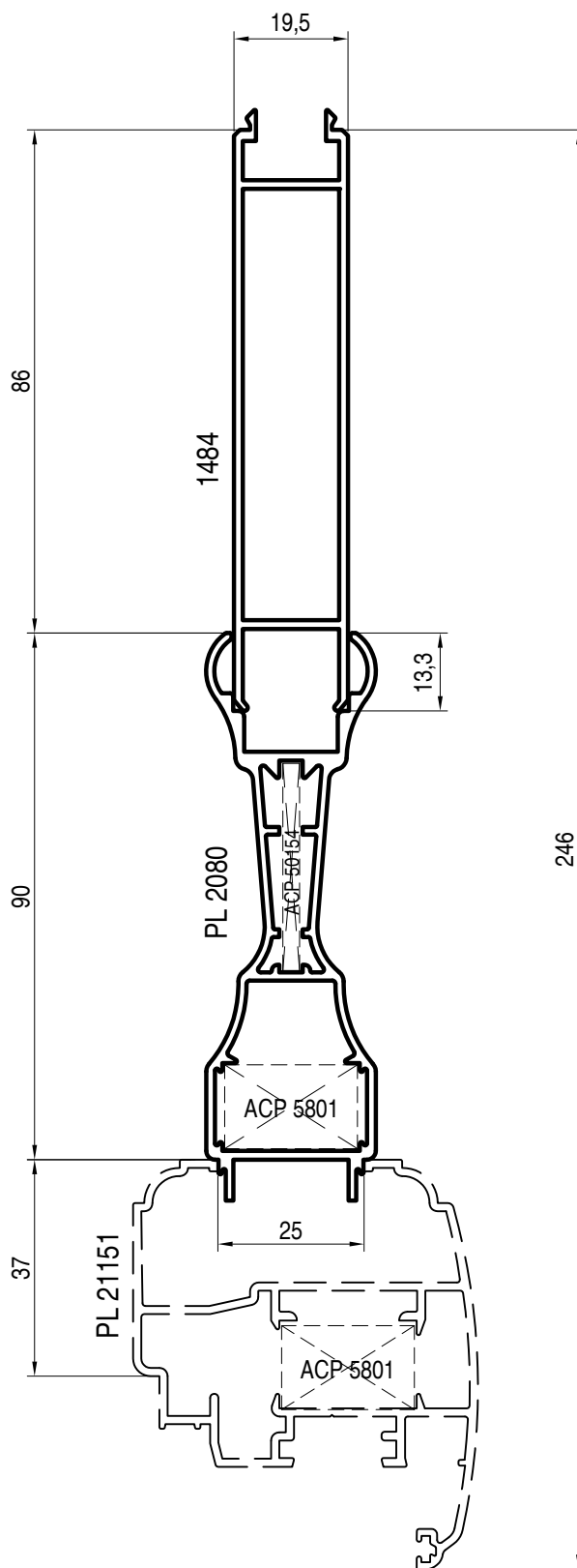
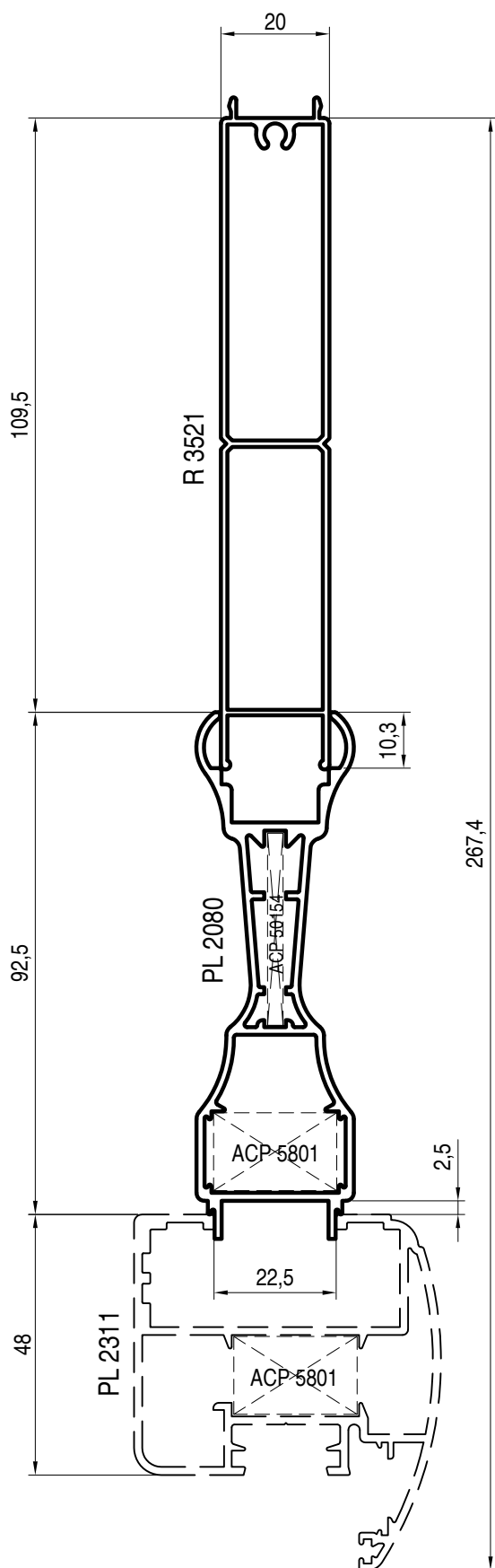

il profilo PL 2080 può essere abbinato ad ante vetro infilare cava 25-22,5 mm e può ricevere doghe di 19,5-20 mm

finestre a nastro - giunto di dilatazione

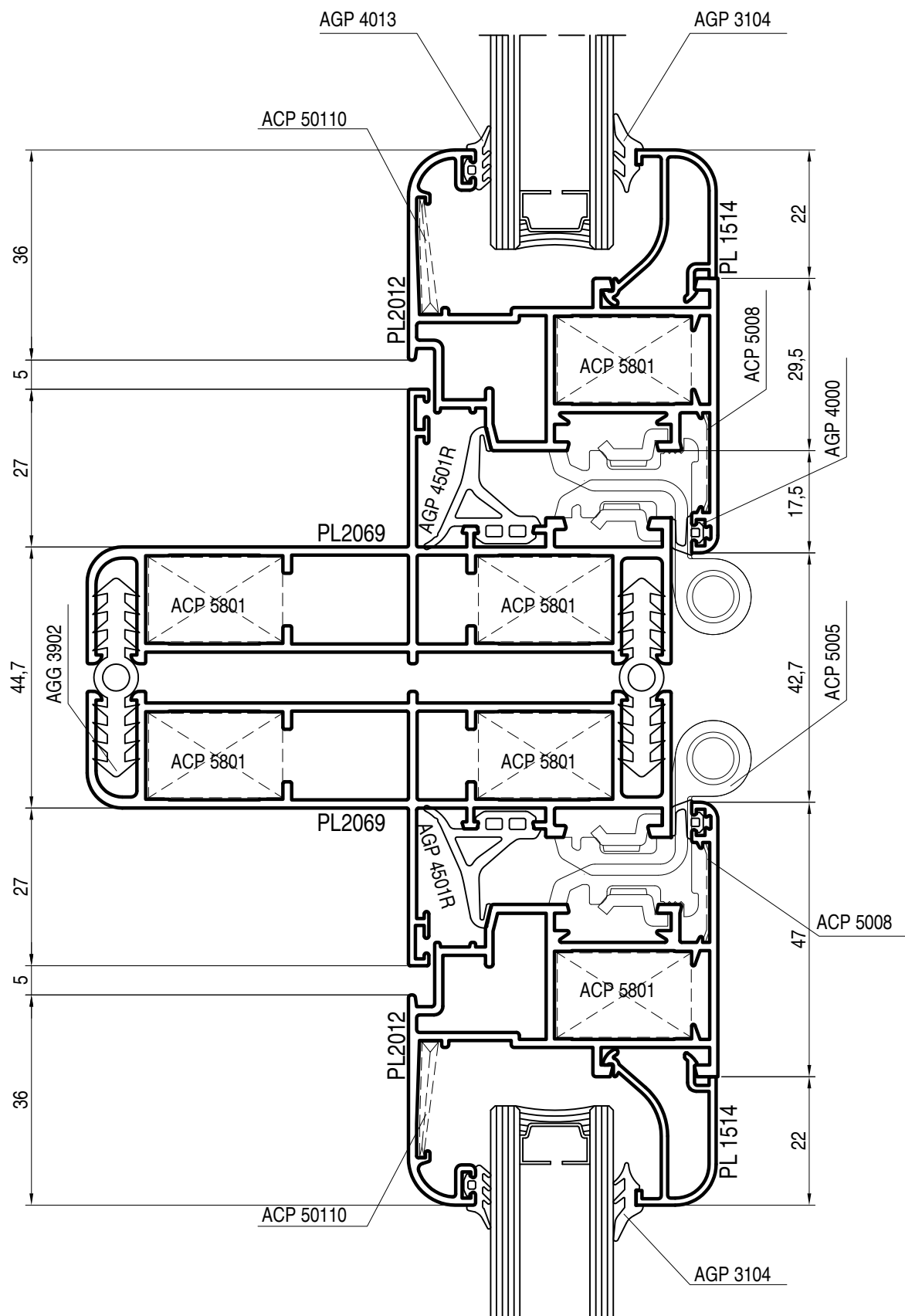

porta scorrevole automatica - nodo laterale/centrale

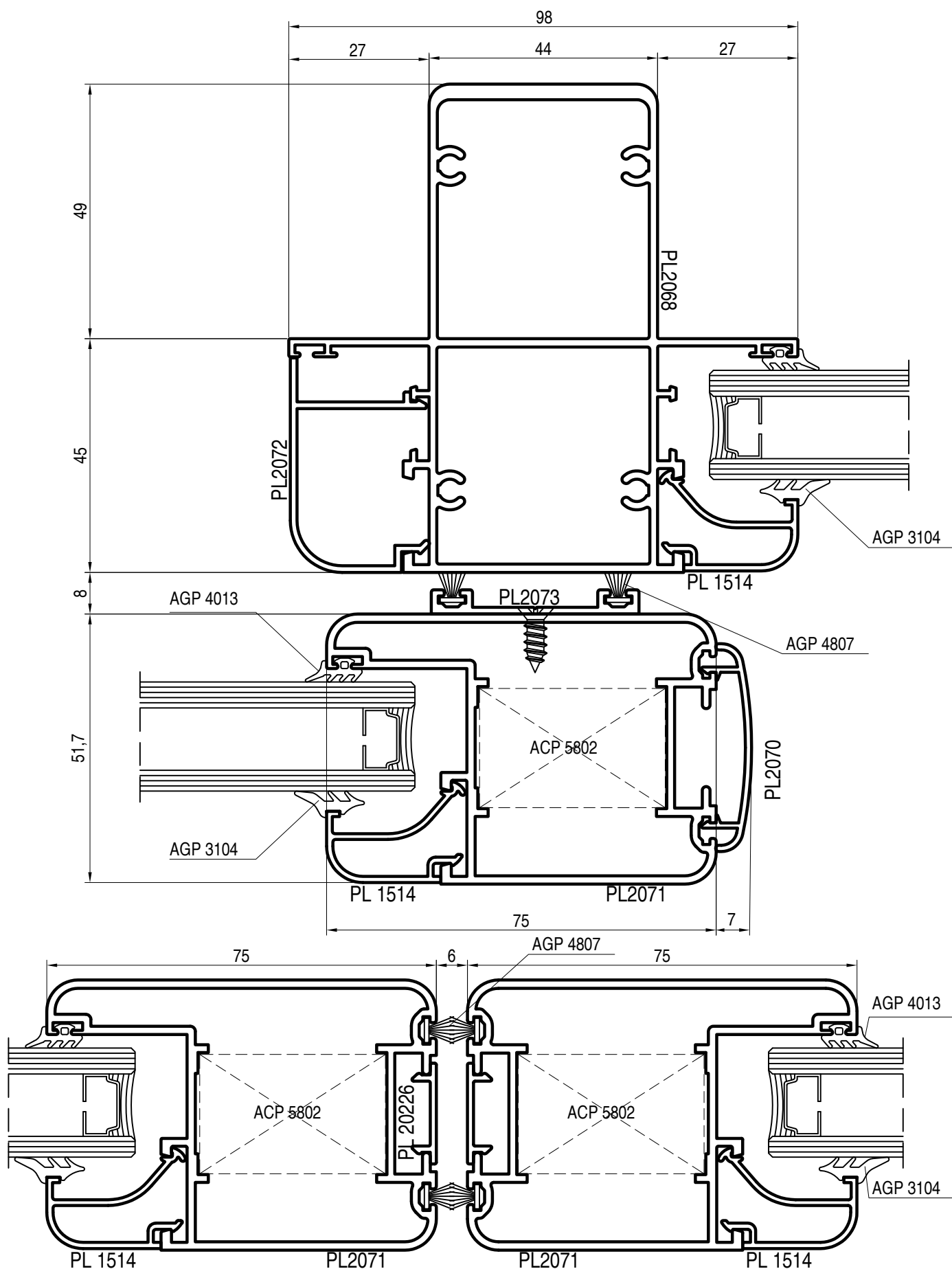

porta scorrevole automatica - nodo a pavimento

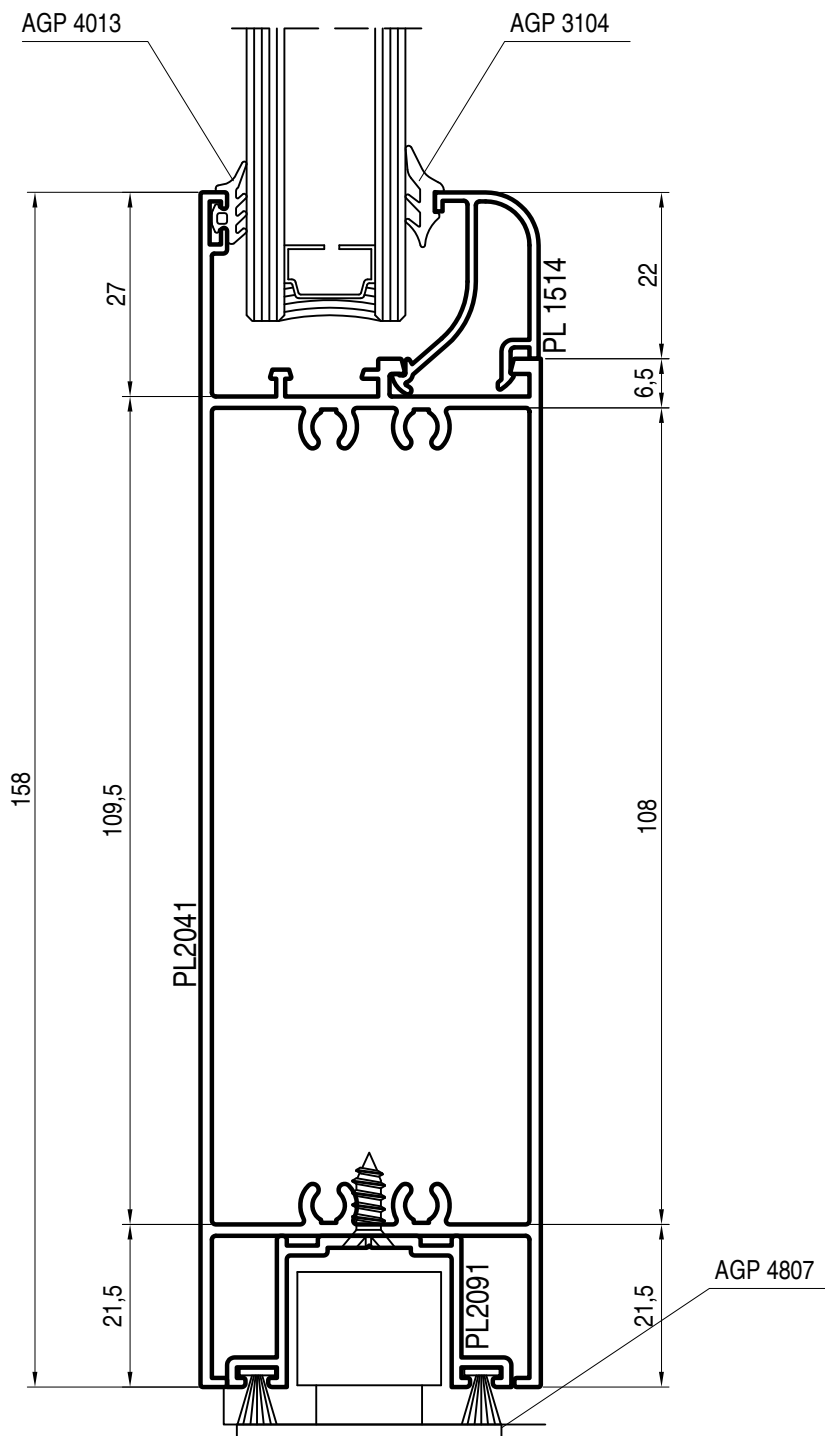

finestre a nastro - pilastro con due apribili

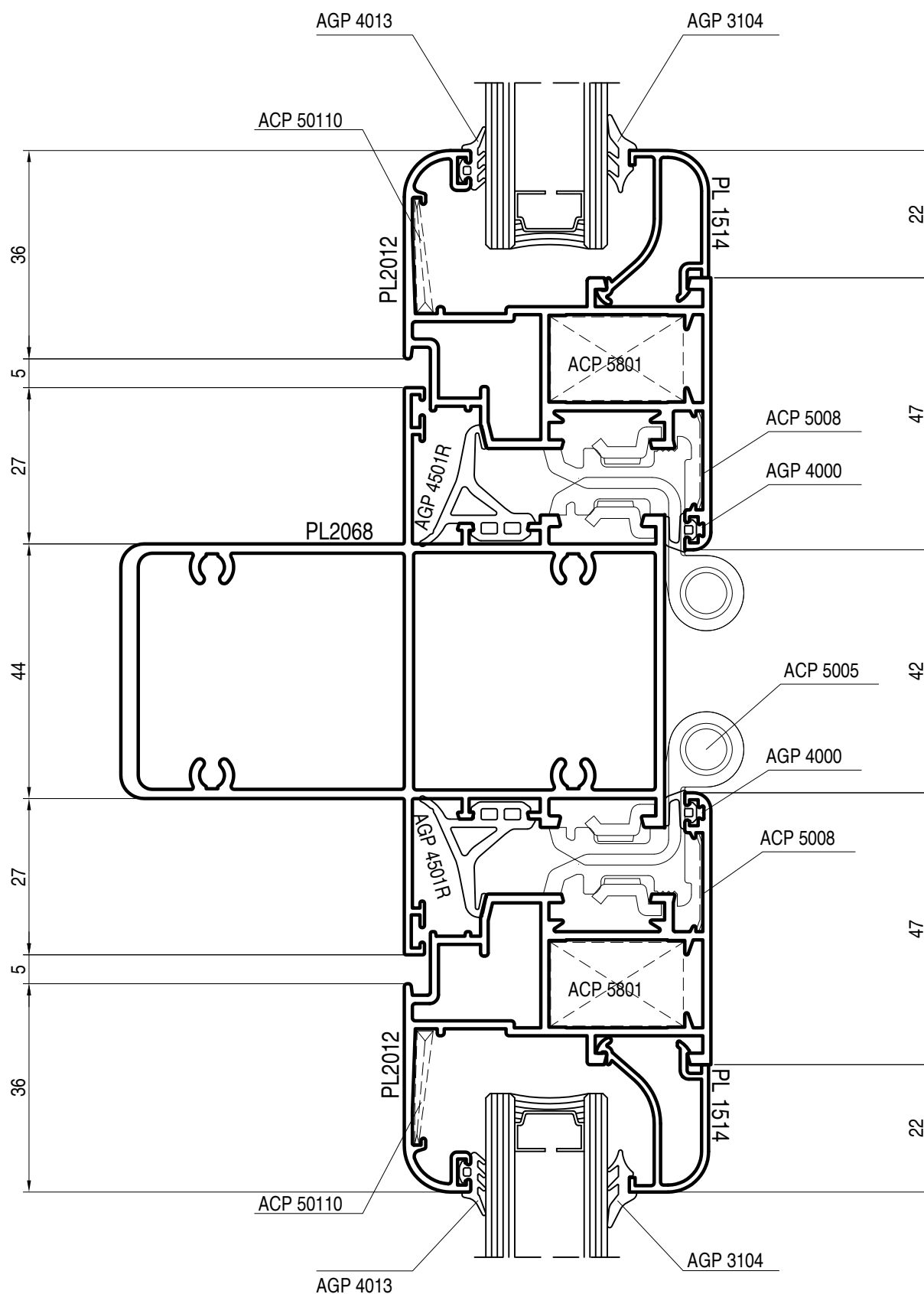

porte interne - nodo laterale

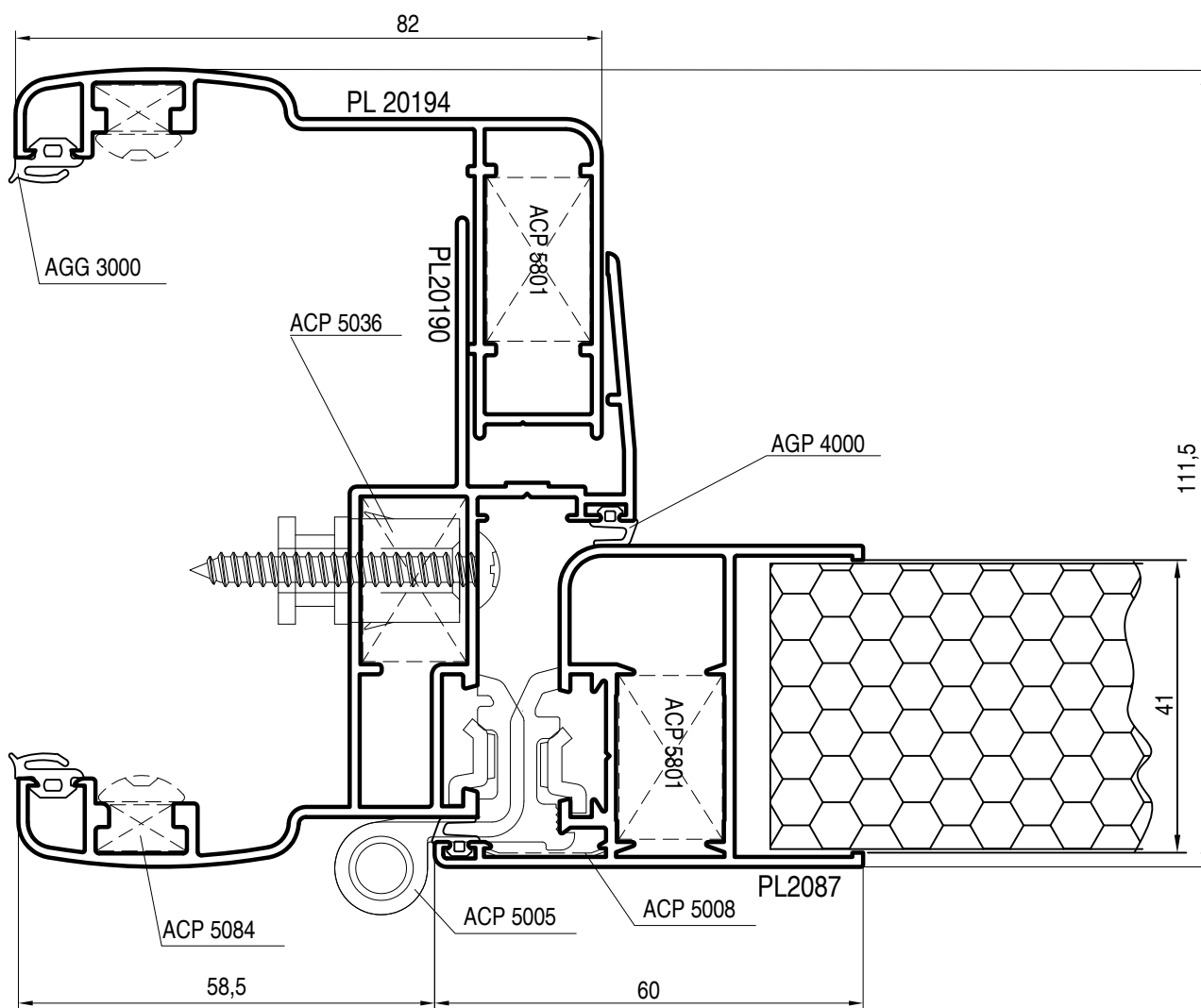
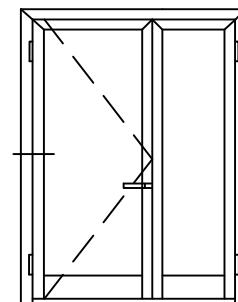

porte interne - nodo centrale

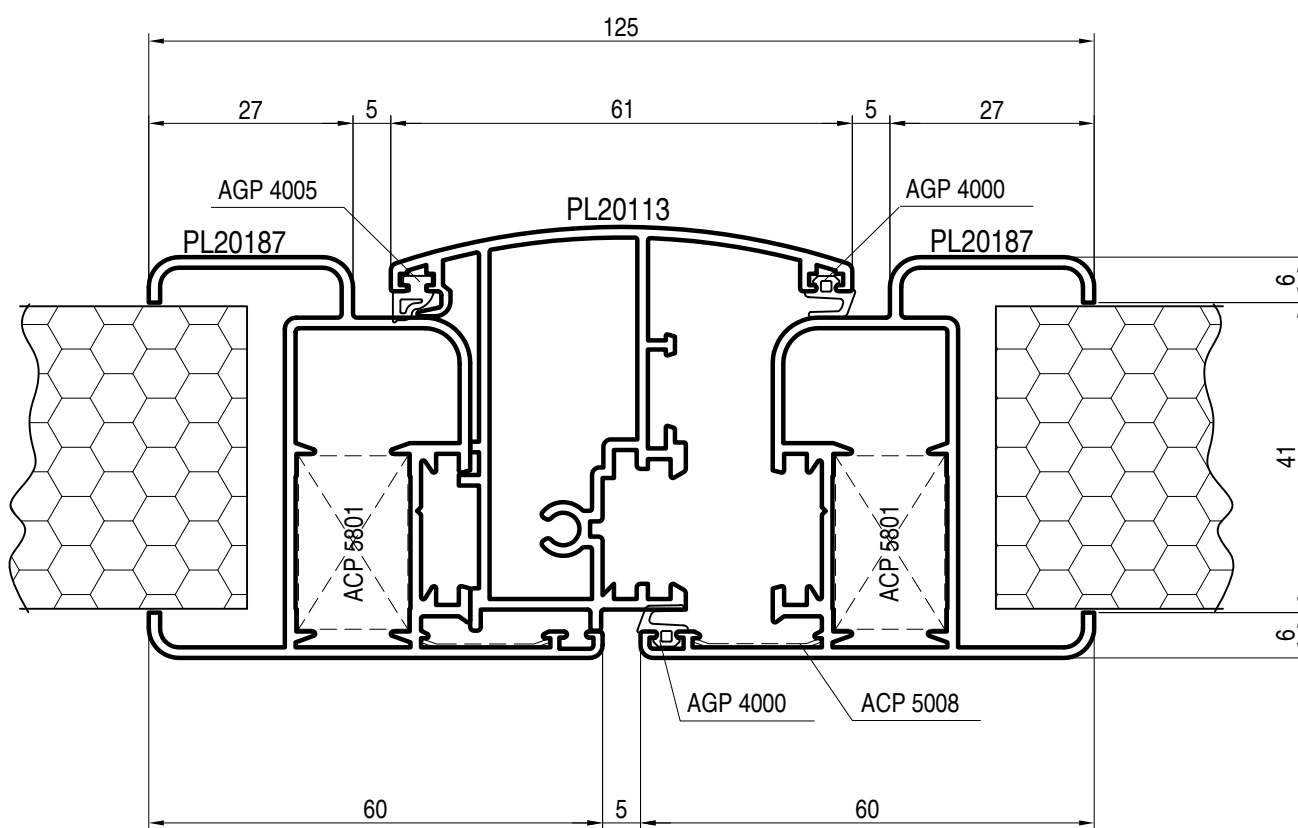
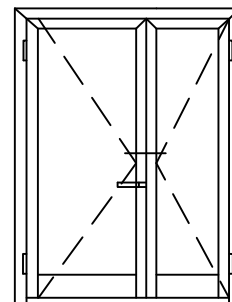

nodo profilo angolo variabile

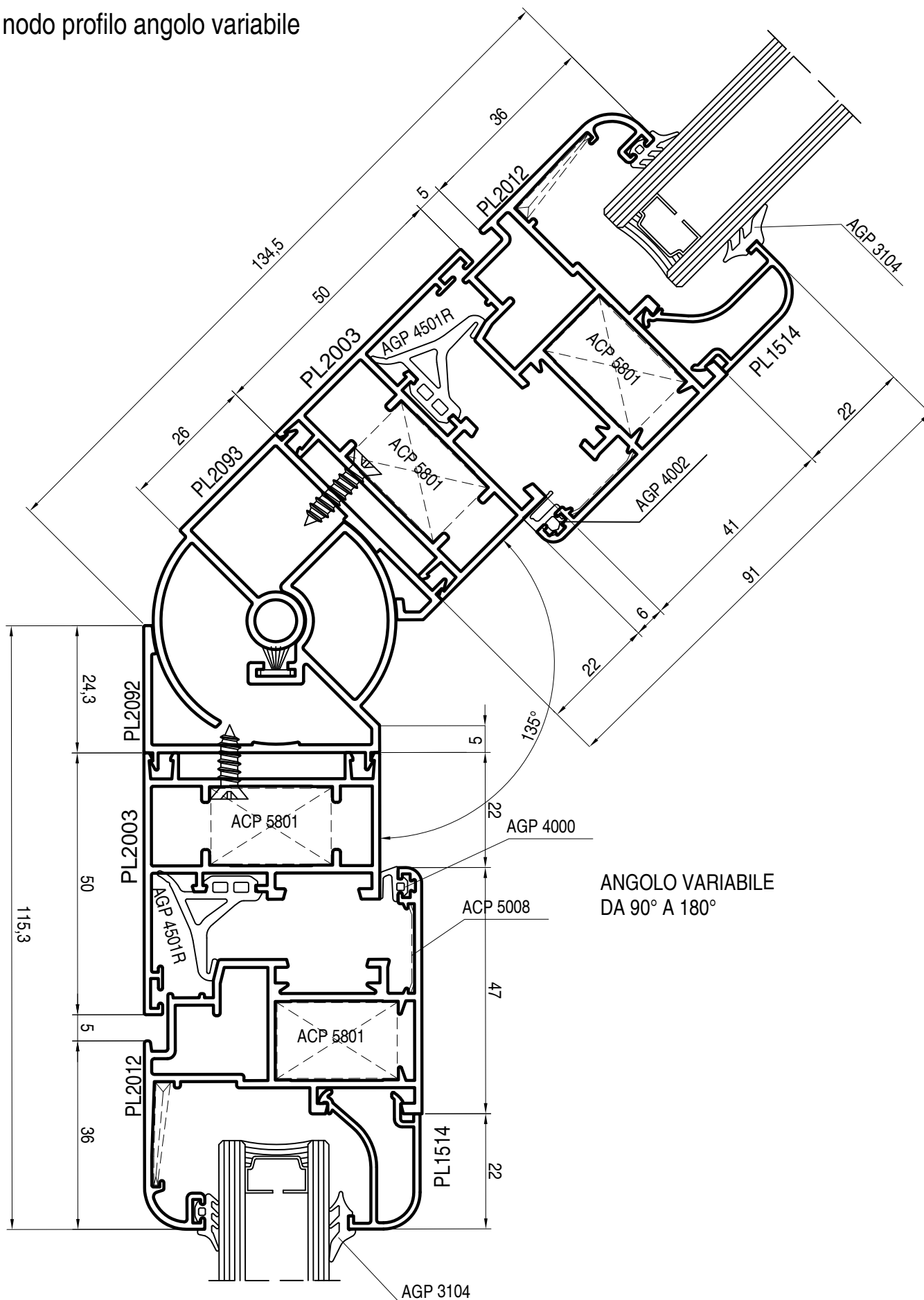

telaio capannoni - nodo perimetrale

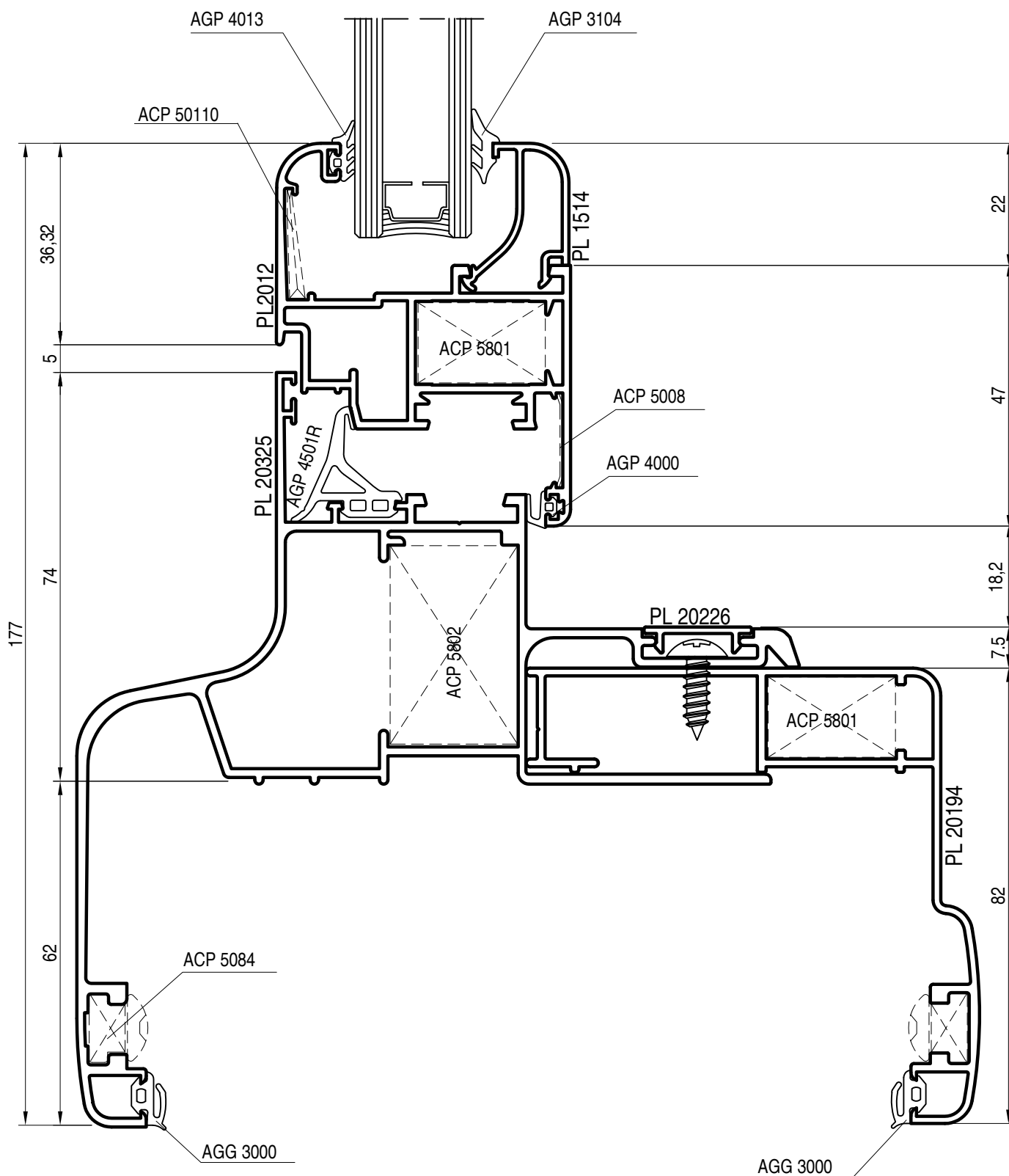

telaio porta imbotti- nodo perimetrale

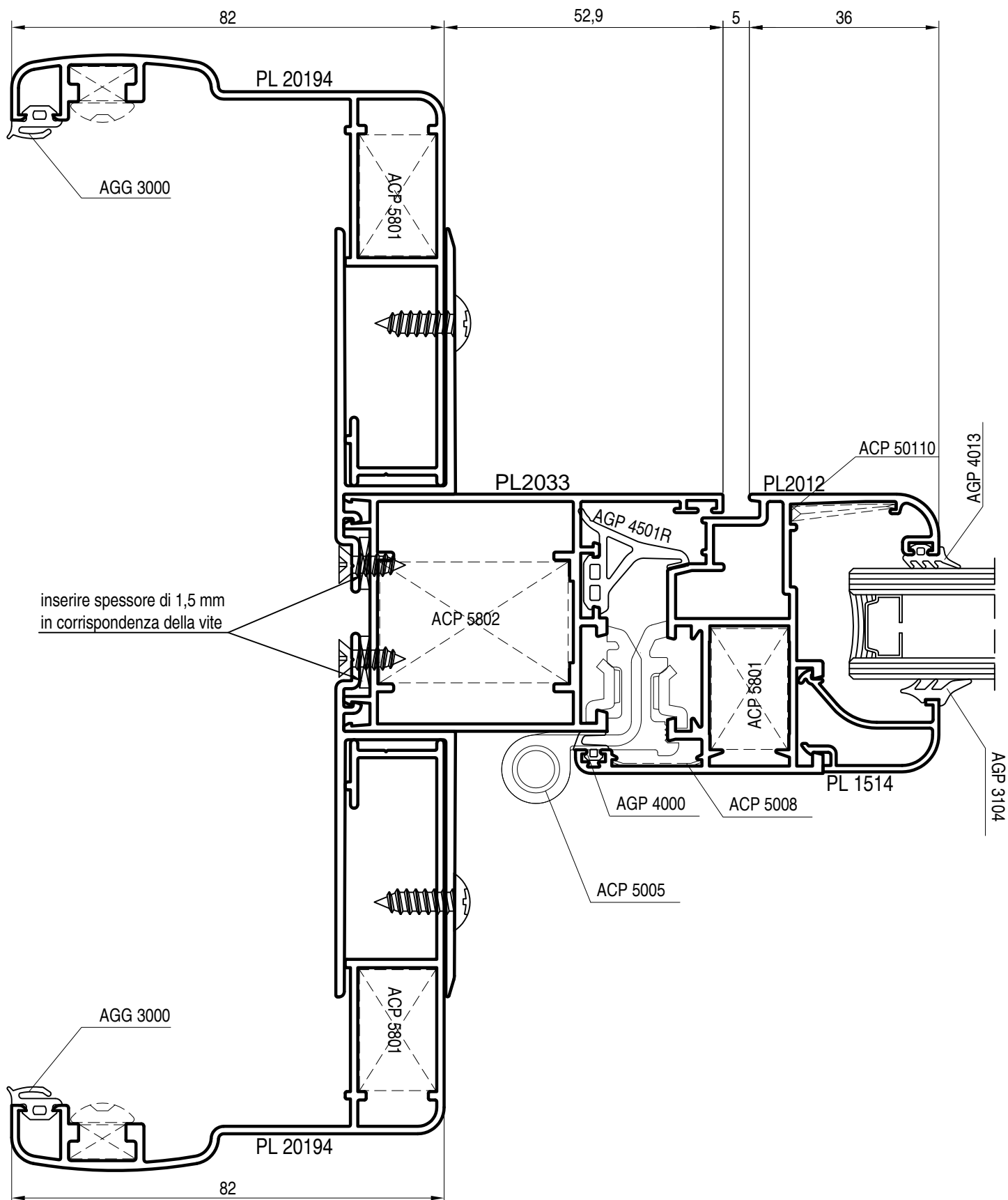

imbotti porte interne - range d'applicazione

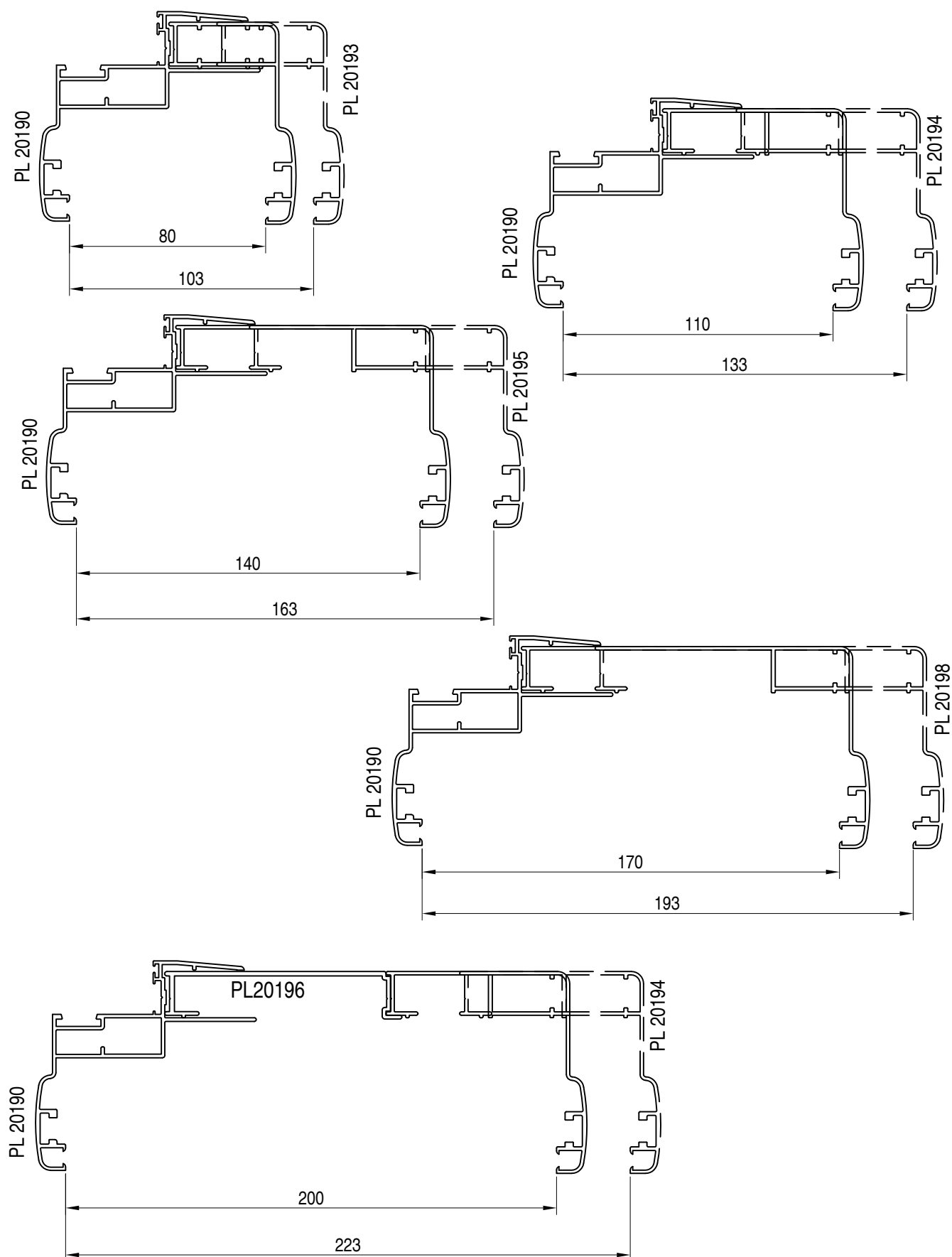

imbotti porte interne - range d'applicazione

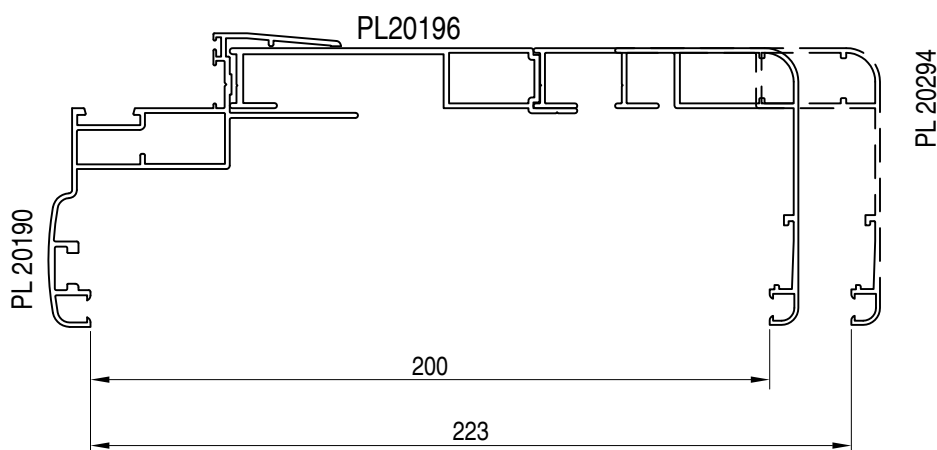
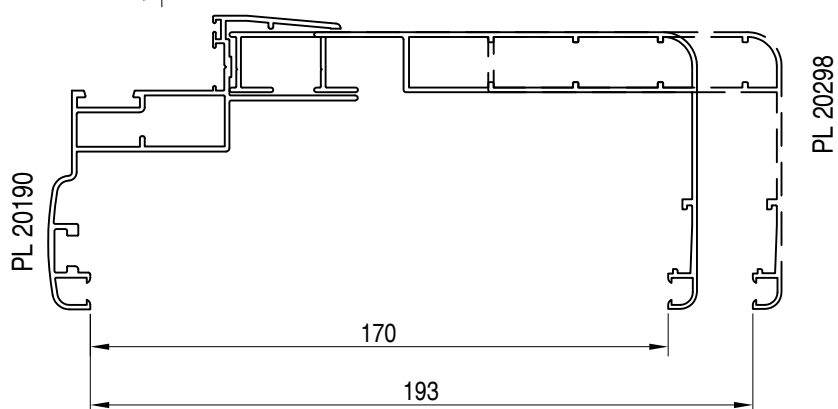
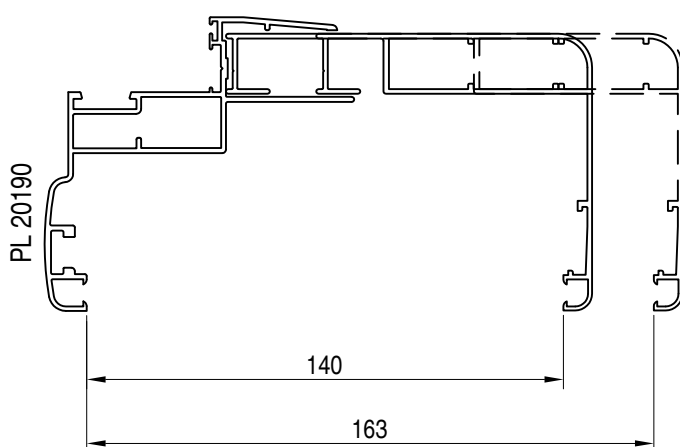
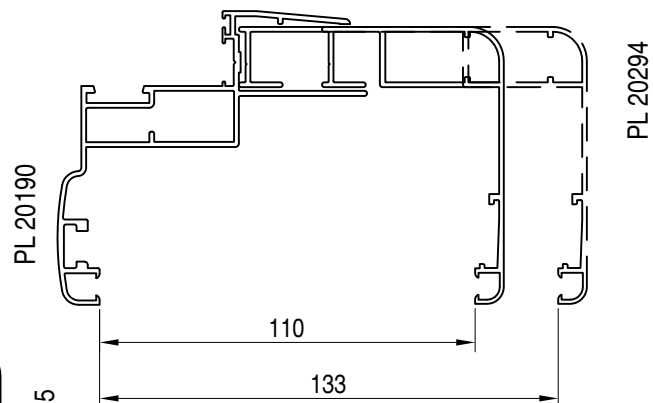
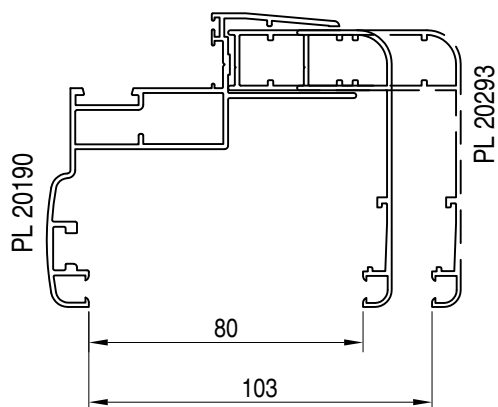

imbotti capannoni - range d'applicazione

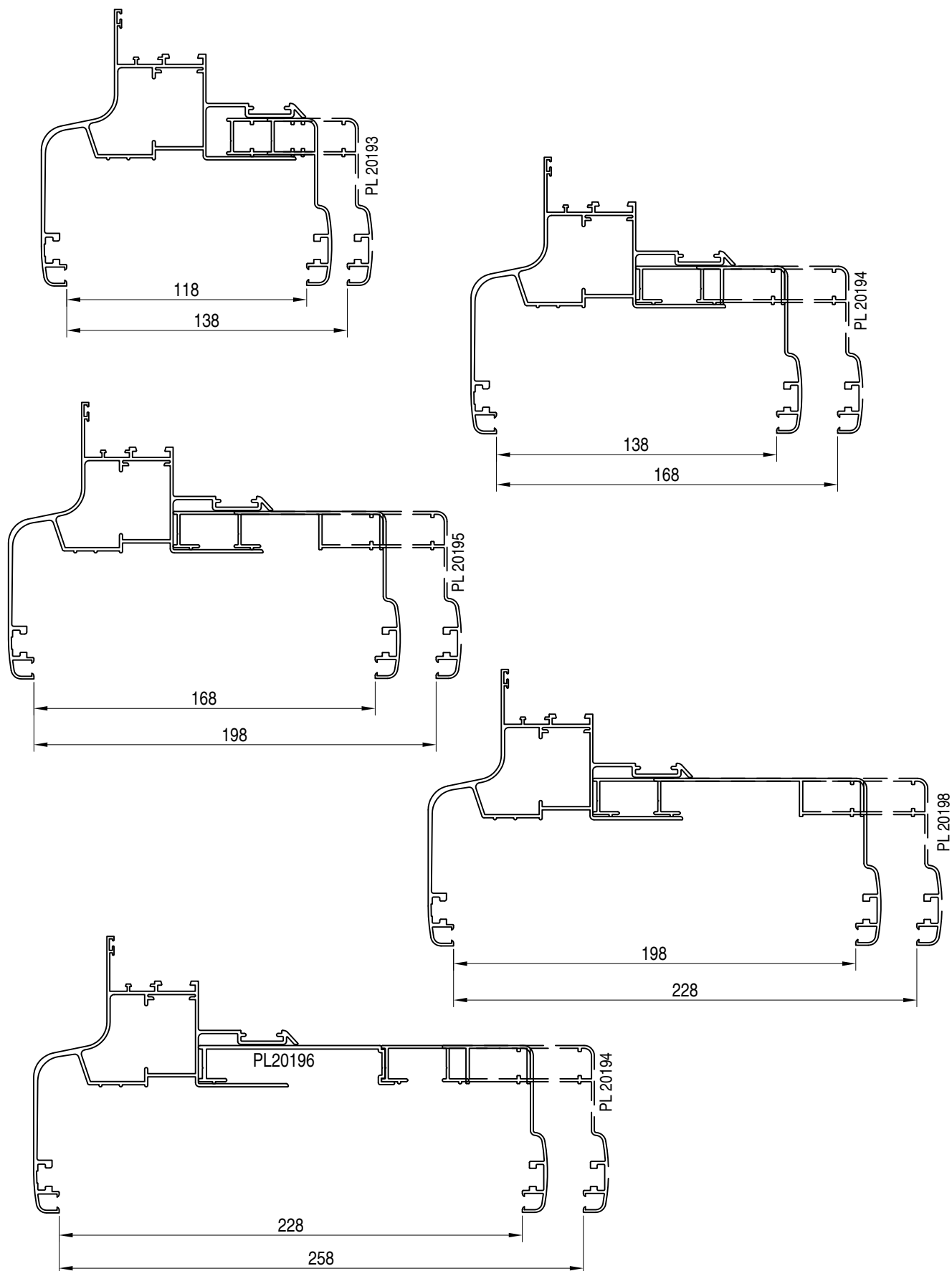

imbotti capannoni - range d'applicazione

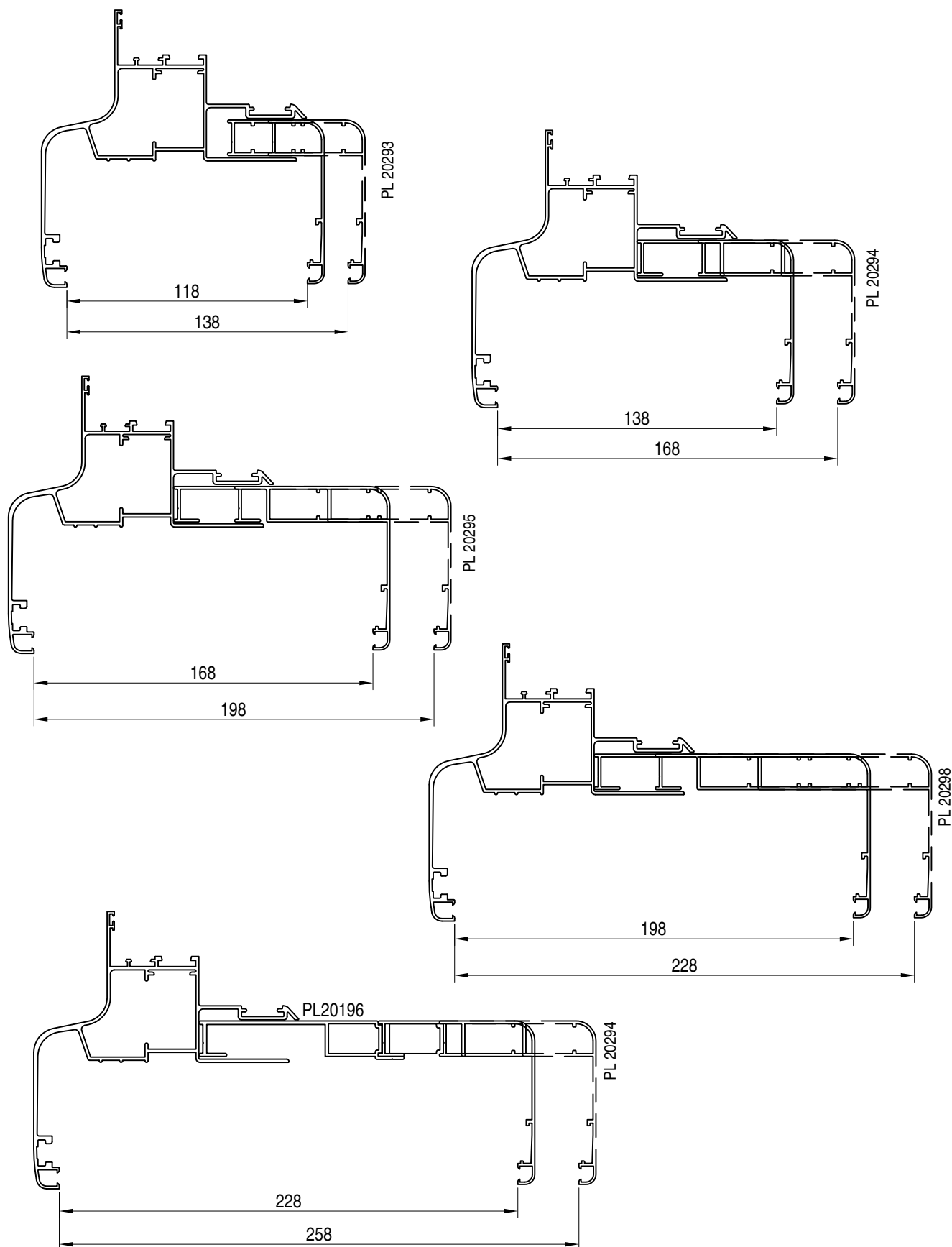

finestrature a nastro - nodo superiore

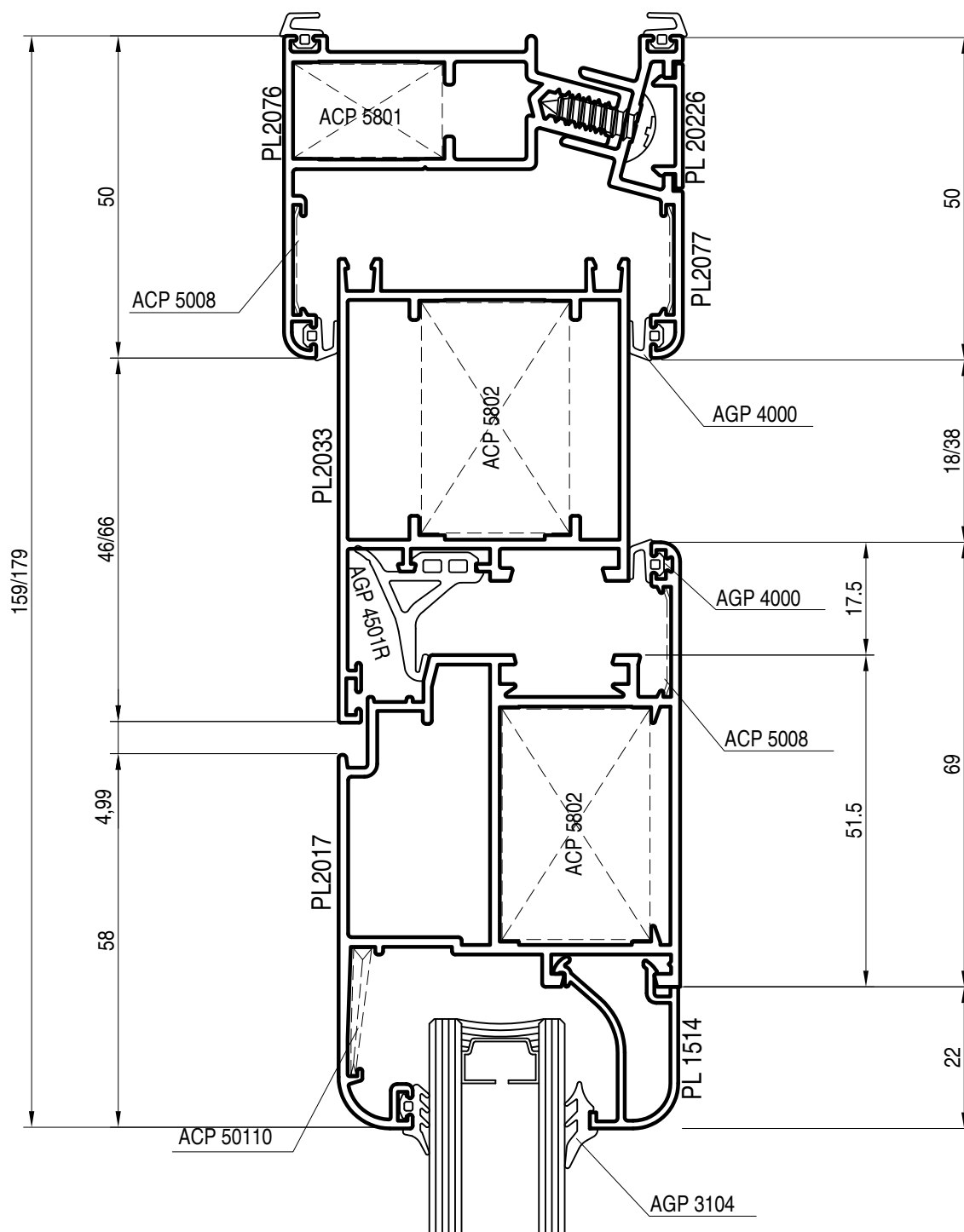

finestrature a nastro - giunto di dilatazione

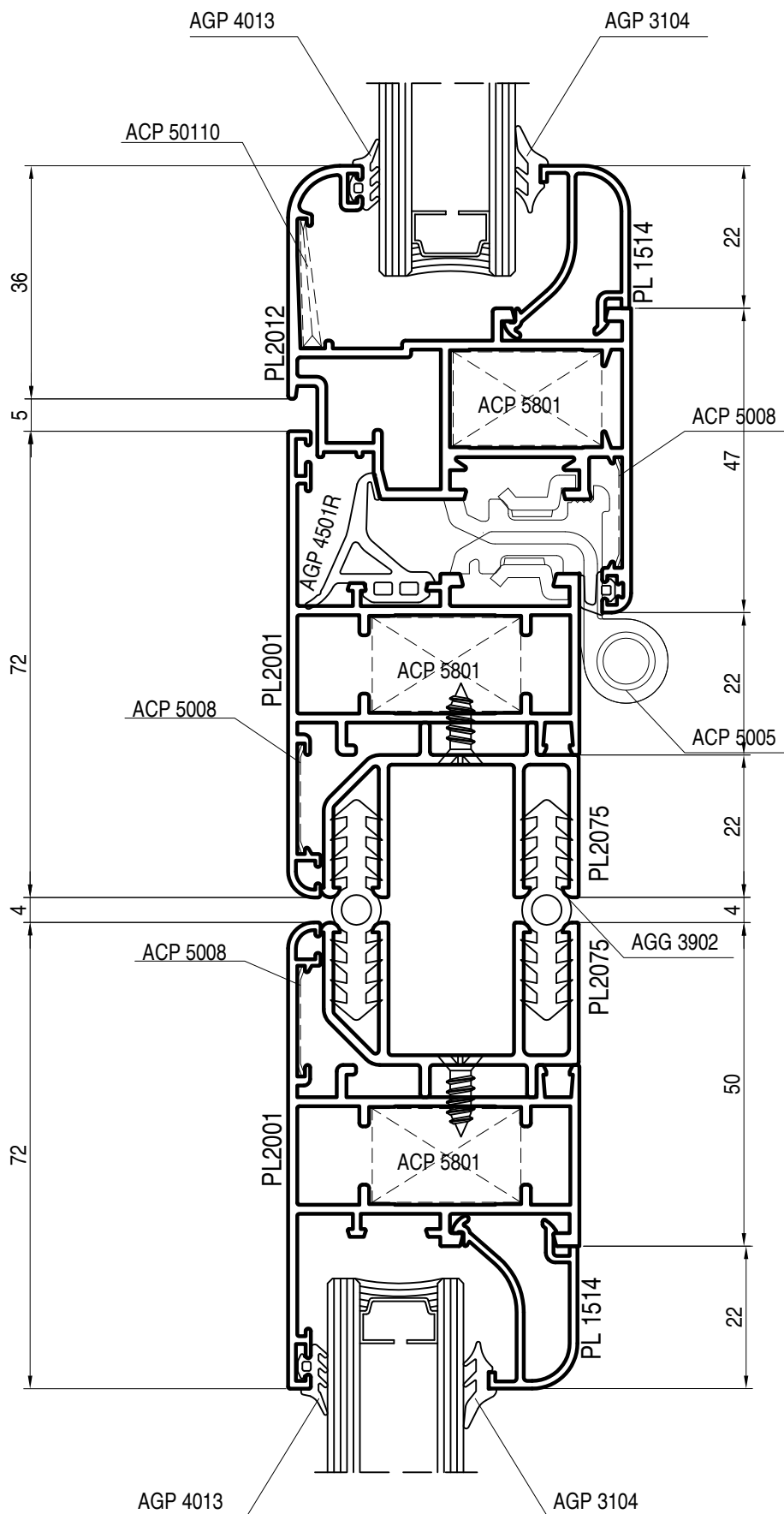

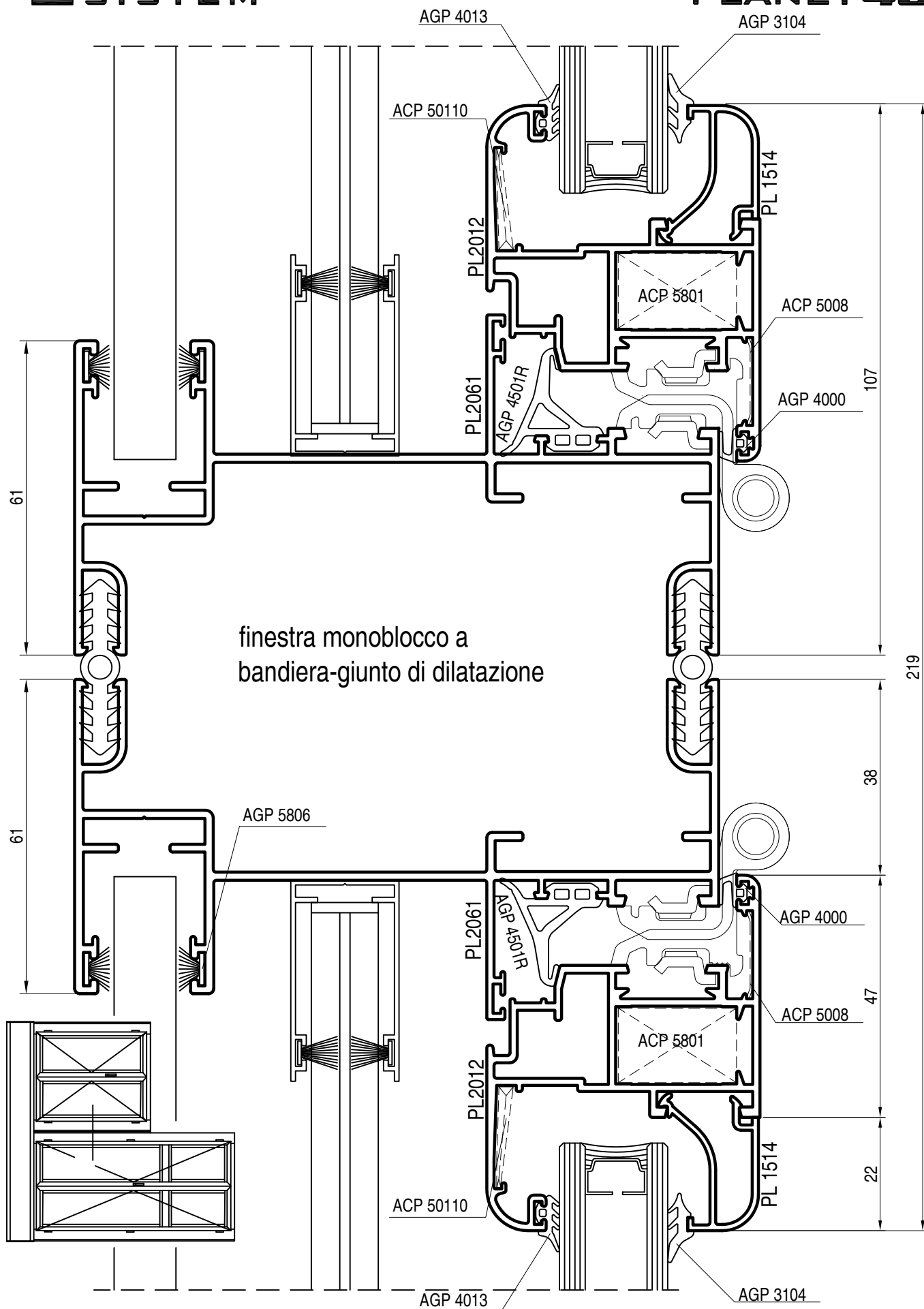

monoblocco chiuso - nodo laterale più zanzariera

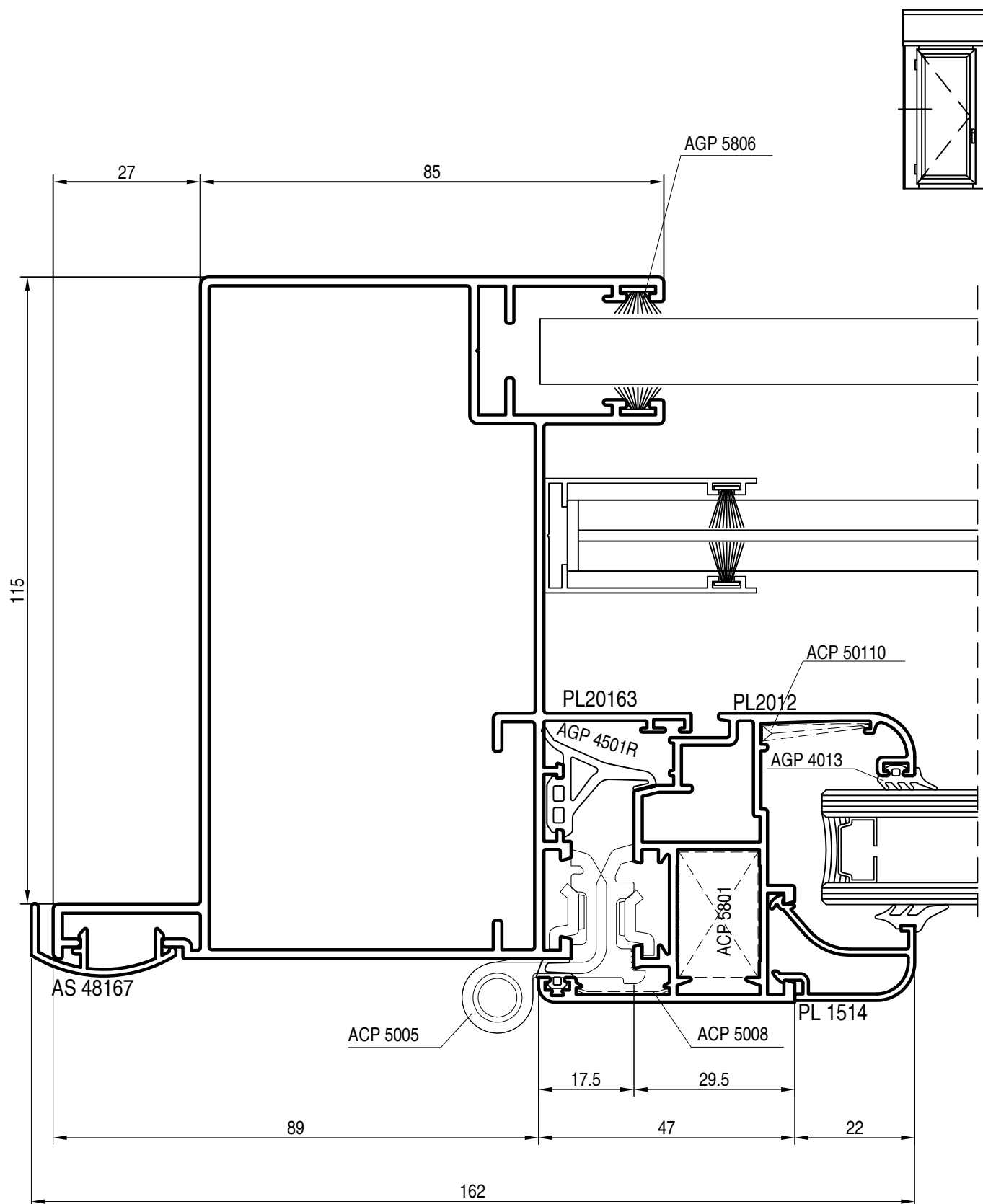

monoblocco aperto anta/ribalta - nodo laterale più zanzariera

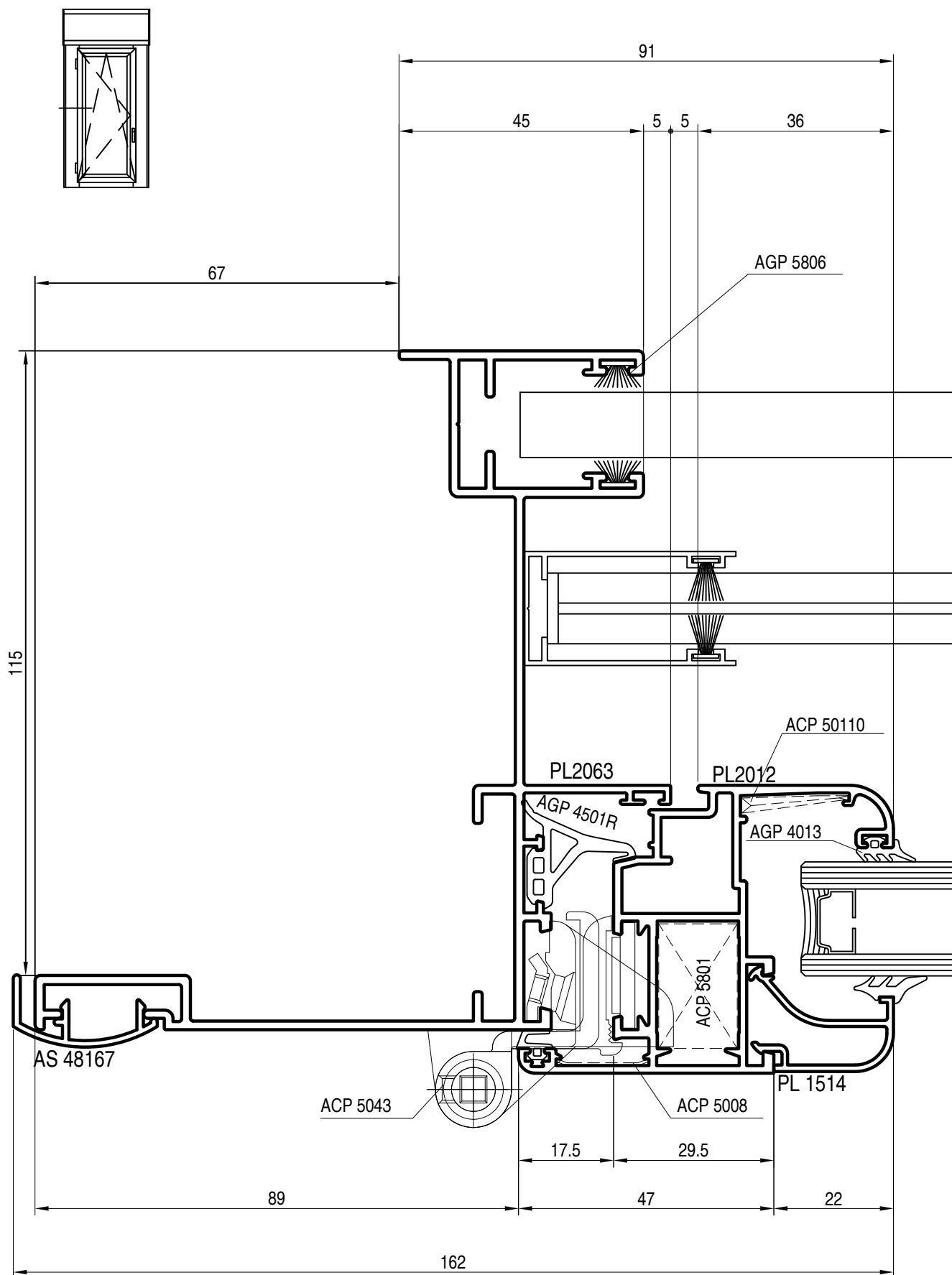

cassonetto monoblocco più zanzariera

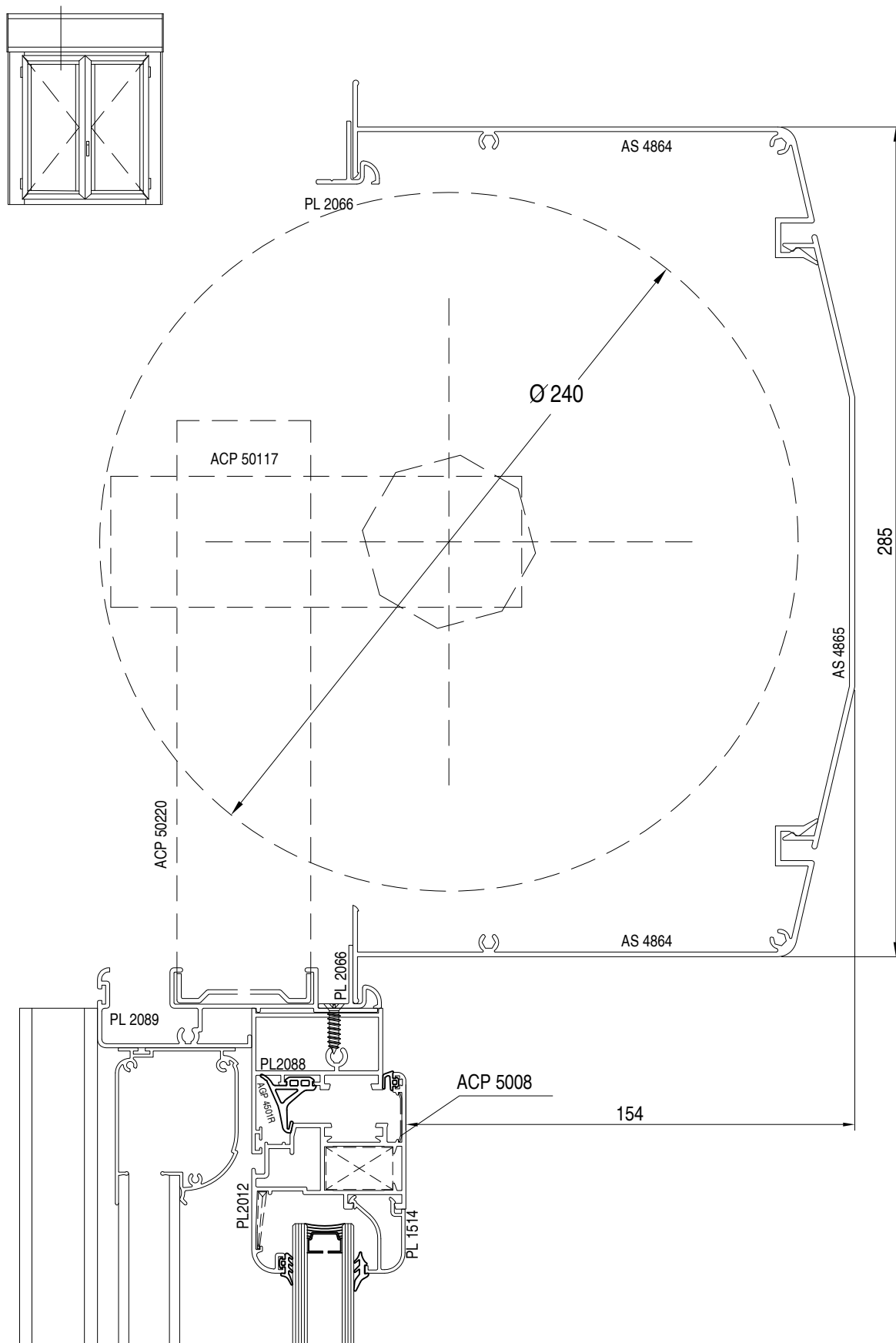

scorrevole parallelo - nodo inferiore

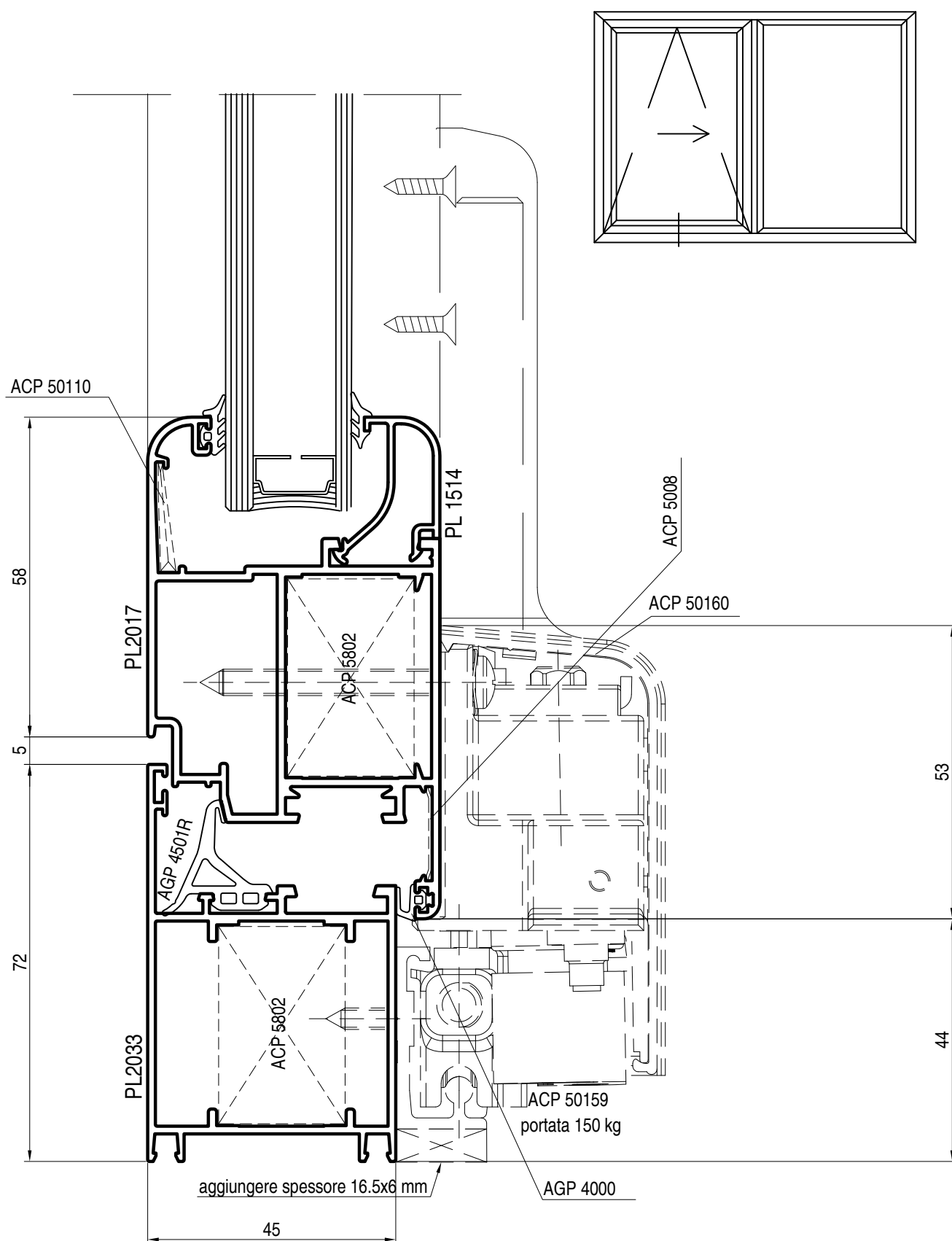

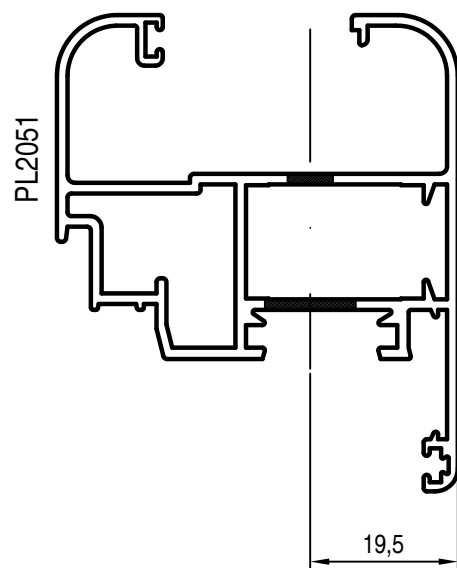
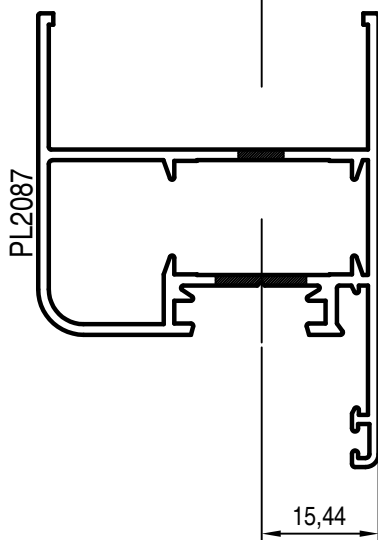
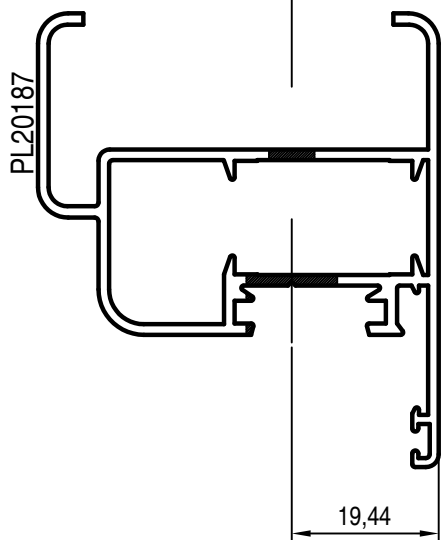
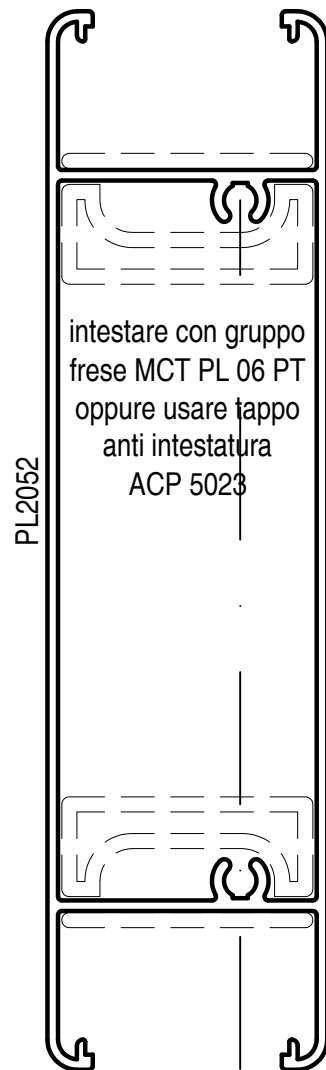
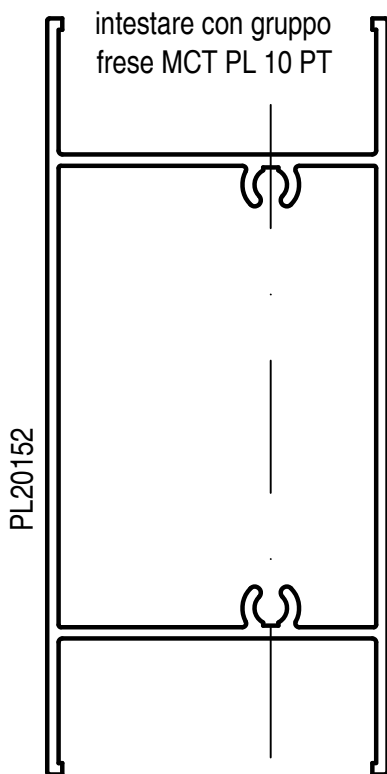
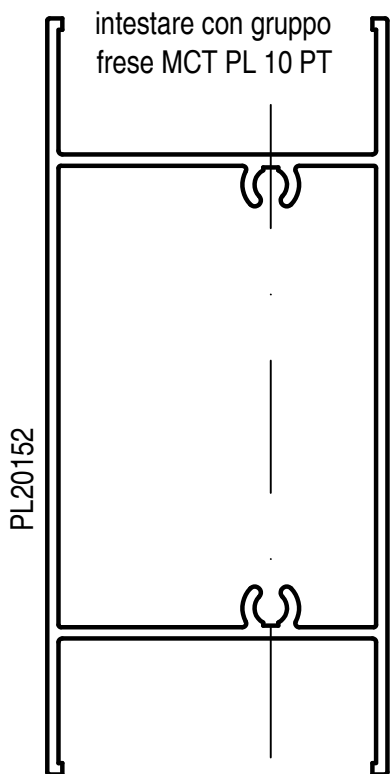

fissaggio fasce al montante

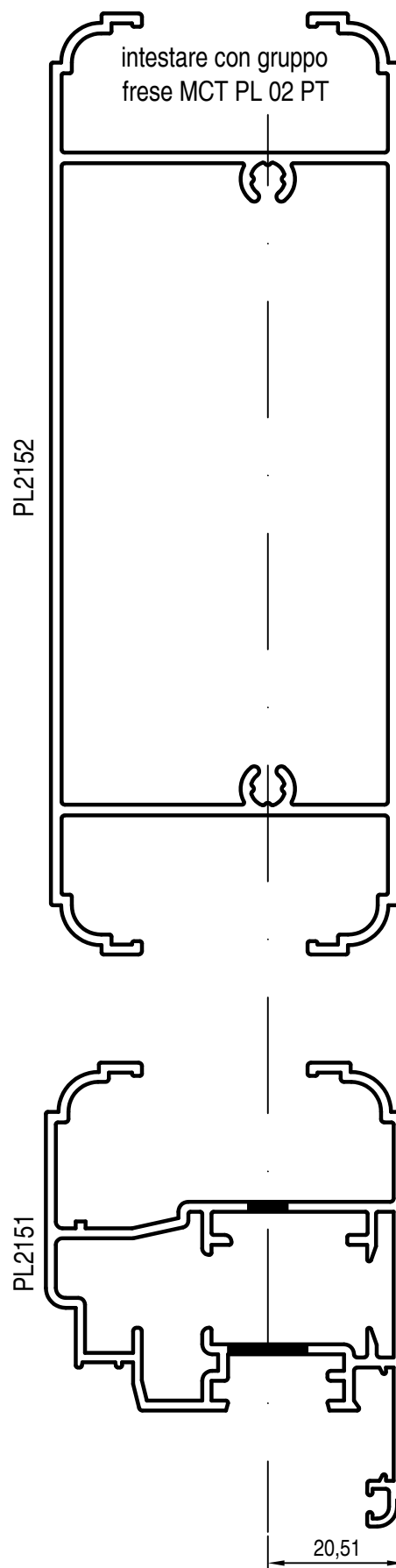
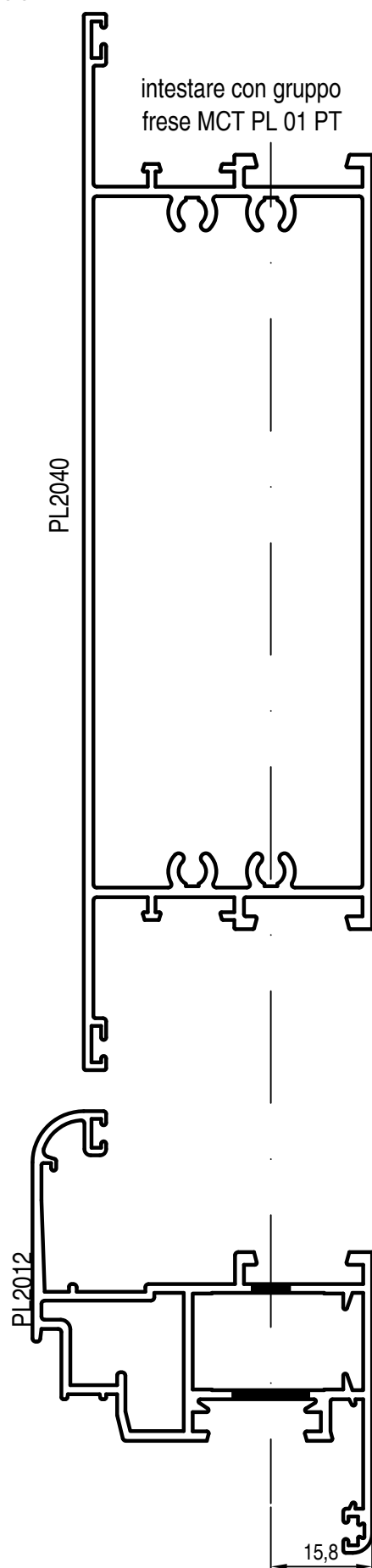

Elenco attrezzature

	<p>MCT PL 01PT</p> <p>Gruppo frese per serie Planet 45 escluso vetro infilare PL 2040, PL 2041 e PL 20138</p>		<p>MCT PL 319 06 01</p> <p>Punzonatrice parziale serie Planet e Global</p>
	<p>MCT PL 02PT</p> <p>Gruppo frese per serie Planet 45 solo profili vetro ad infilare modanati tipo: PL 2152, PL 2153, PL 21148</p>		<p>MCT PL 402 01 98</p> <p>Polmoncino per lavorazione squadretta con pulsante da 10,5mm</p>
	<p>MCT PL 06PT</p> <p>Gruppo frese per serie planet 45 solo vetro ad infilare tipo: PL 2052, PL20148</p>		<p>MCT PL 402 01 96</p> <p>Polmoncino per lavorazione squadretta a spinare</p>
	<p>MCT PL 10PT</p> <p>Gruppo frese per serie planet 45 porte interne tipo: PL 20152</p>		<p>MCT PL 319 06 05</p> <p>Punzonatrice scarico acqua universale</p>
	<p>MCT PL 14460</p> <p>Punzonatrice completa per eseguire tutte le lavorazioni specifiche delle serie: Planet 45, 50TT, 62TT, 72HT, Nathura70, 82, 92 Matic 50, 62, 72, Elite Door 72 e telai Slide 80/106 e Slidewood 160</p>		<p>MCT PL JOLLY</p> <p>Punzonatrice parziale per eseguire tutte le lavorazioni specifiche della serie Planet: 45, 50TT, 62TT, Matic, Elite Door e parziali Nathura, Slide, squadrette e aerazione vetro su anta</p>

	MCT PL 400 03 63 Controsagoma per intestatura fermavetri arrotondati qualora si volessero tagliare a 45° senza utilizzare gli angoletti il kit è utilizzabile sulle intestatrici EM140G
	MCT PL 350 31/45 Fresa per intestatura fermavetri arrotondati qualora si volessero tagliare a 45° senza utilizzare gli angoletti il kit è utilizzabile sulle intestatrici EM140G

	EM 140G Intestatrice per fermavetri arrotondati con morsa e gruppo frese
--	--

punzonatrice planet MCT PL 3190601

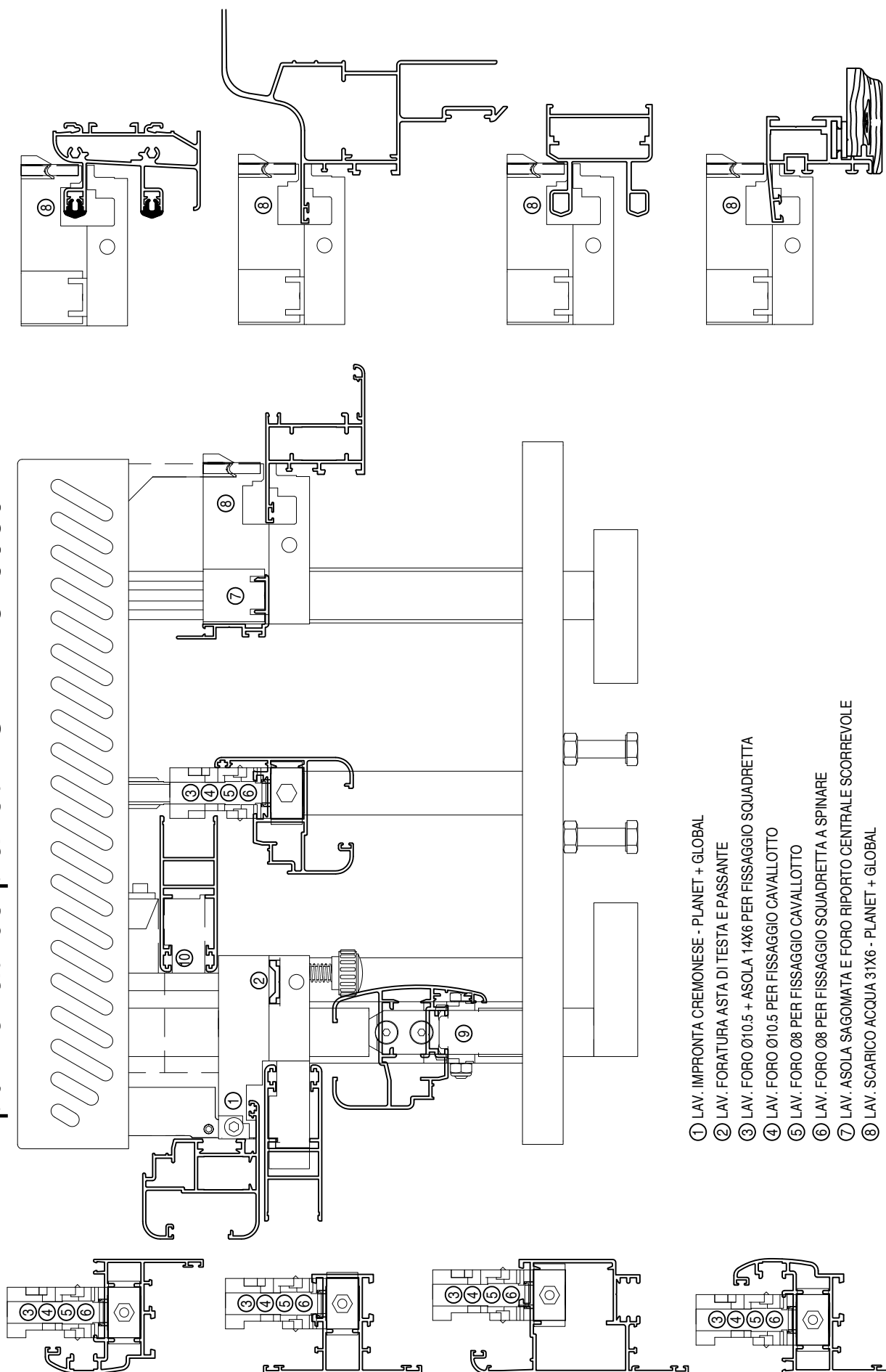

- ① LAV. IMPRONTA CREMONESE - PLANET + GLOBAL
- ② LAV. FORATURA ASTA DI TESTA E PASSANTE
- ③ LAV. FORO Ø10.5 + ASOLA 14X6 PER FISSAGGIO SQUADRETTA
- ④ LAV. FORO Ø10.5 PER FISSAGGIO CAVALOTTO
- ⑤ LAV. FORO Ø8 PER FISSAGGIO CAVALOTTO
- ⑥ LAV. FORO Ø8 PER FISSAGGIO SQUADRETTA A SPINARE
- ⑦ LAV. ASOLA SAGONATA E FORO RIPORTO CENTRALE SCORREVOLE
- ⑧ LAV. SCARICO ACQUA 31X6 - PLANET + GLOBAL
- ⑨ LAV. RASATURA ALETTE PASSAGGIO ASTA - PLANET + GLOBAL
- ⑩ PREDISPOSIZIONE PER AGGANCIO MANIGLIA A INCASSO SCORREVOLE (KIT OPZIONALE 402.00.72)

punzonatrice Planet MCT PL JOLLY

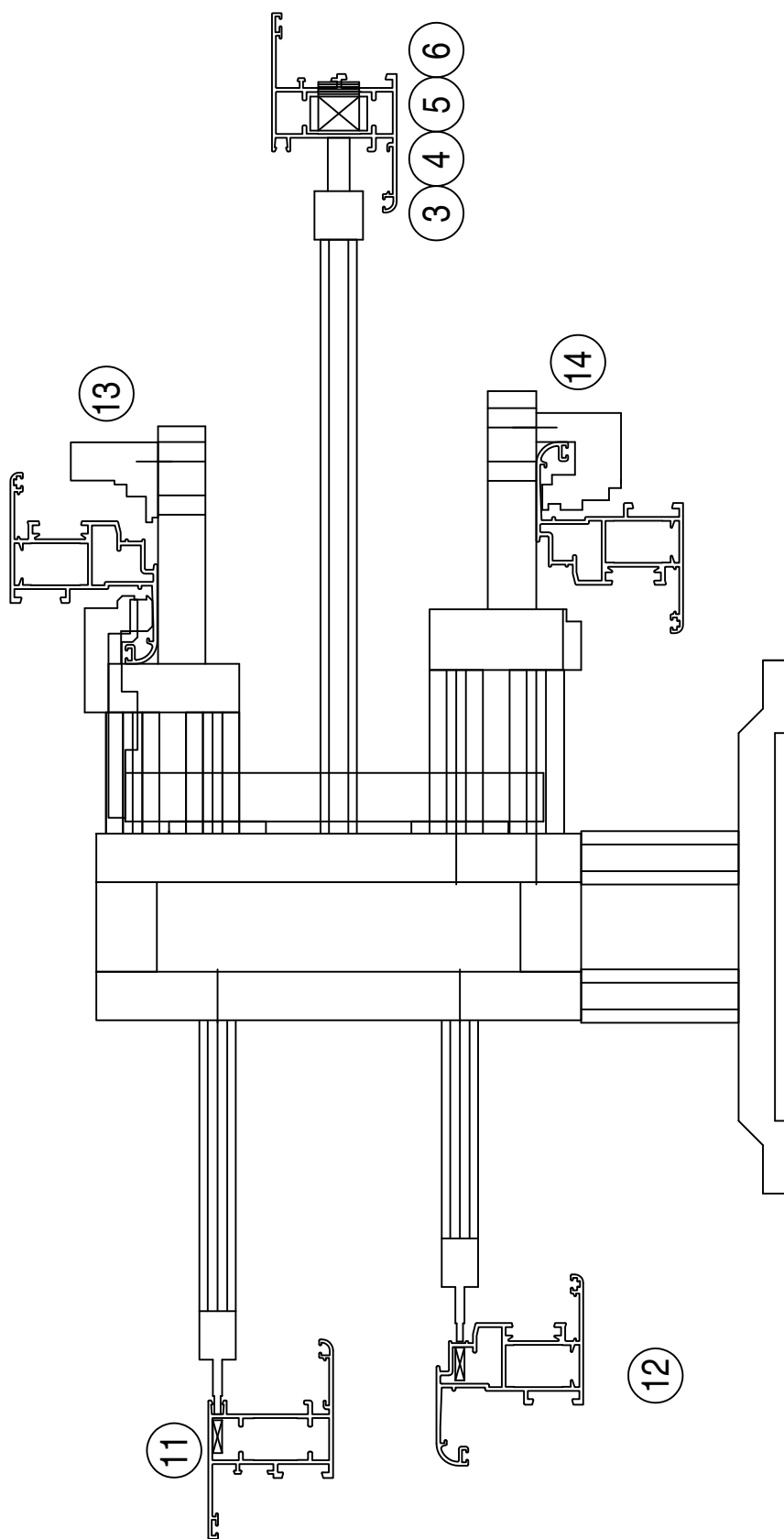

- ③ LAV. FORO Ø10.5 + ASOLA 14X6 PER FISSAGGIO SQUADRETTA
- ④ LAV. FORO Ø10.5 PER FISSAGGIO CAVALLOTTO
- ⑤ LAV. FORO Ø8 PER FISSAGGIO CAVALLOTTO
- ⑥ LAV. FORO Ø8 PER FISSAGGIO SQUADRETTA MULTIFUNZIONE
- ⑪ FORO Ø 3 mm PER SPINA ACP5030 SQUADRETTA ACP 50153 , ACP 50154
- ⑫ FORO Ø 4 mm PER VITE ACP 50155 SQUADRETTA ACP 50153 , 50154
- ⑬ ASOLA INTERNA PER REAZIONE ANTA
- ⑭ ASOLA ESTERNA PER AREAZIONE ANTA

punzonatrice completa MCT PL 14460

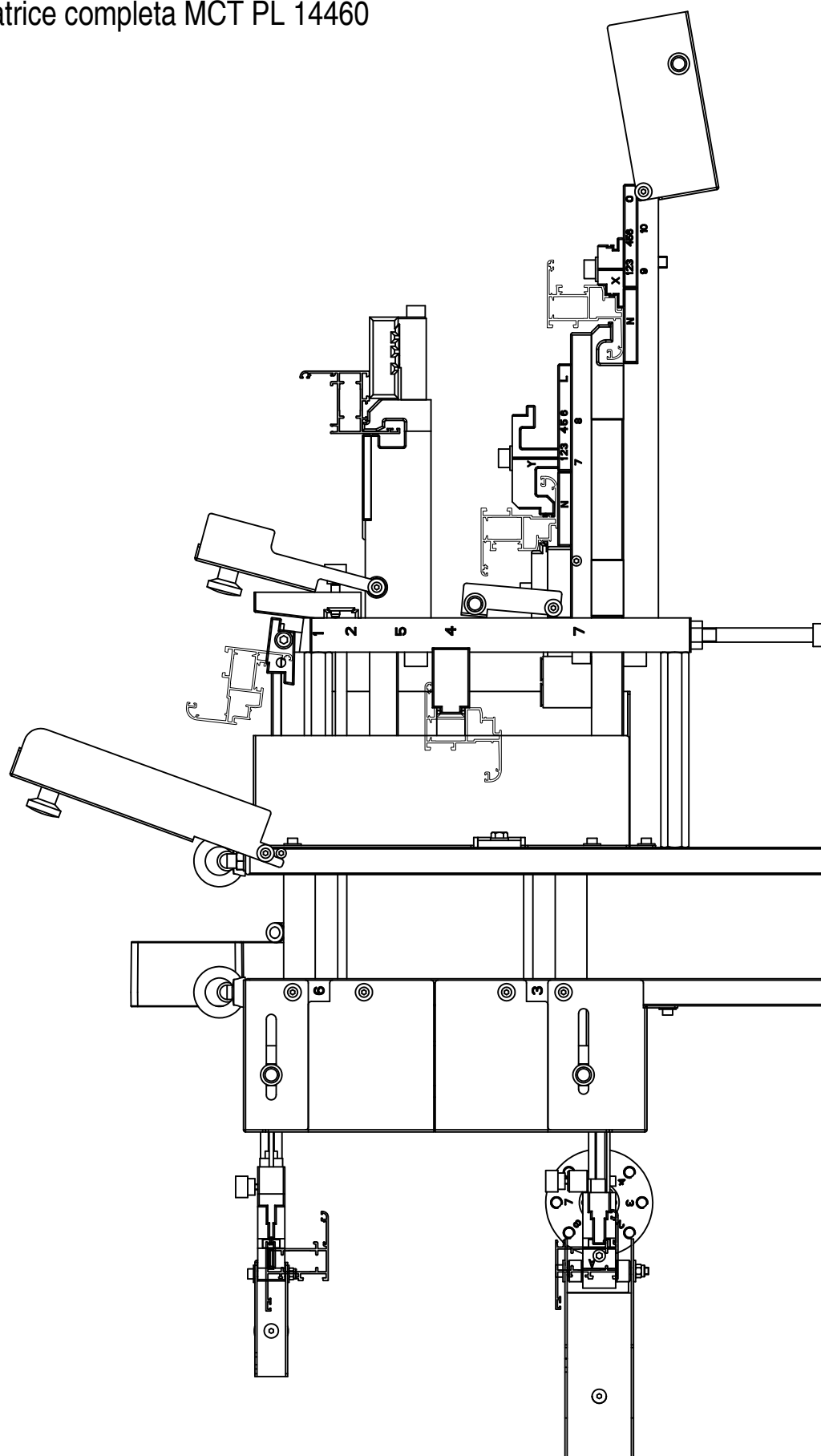

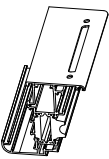
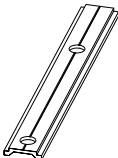
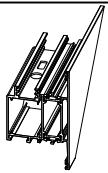
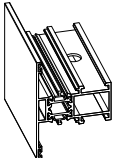
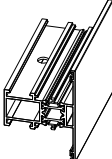
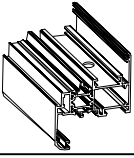
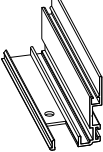
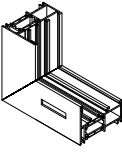
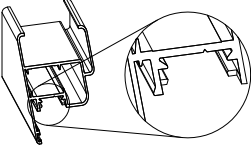
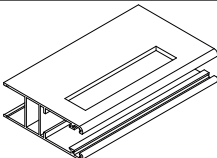
NUMERO LAVORAZIONE	DESCRIZIONE LAVORAZIONE	IMMAGINE LAVORAZIONE	LAVORAZIONE CON PUNZONATRICE MTC PL 3190601	LAVORAZIONE CON PUNZONATRICE MCT PL JOLLY	LAVORAZIONE CON PUNZONATRICE MCT PL 14460
1	ASOLA E FORI BLOCCAGGIO CREMONESE INTERASSE 104 mm OPPURE 130 mm		sì	no	sì
2	FORO ASTINA DI TESTA 8mm OPPURE PASSANTE		sì	no	sì
3	FORO Ø10.5mm PER AGGANCIAMENTO E ASOLA 14x6 PER CHIAVE SQUADRETTA A PULSANTE		sì	sì	sì
4	FORO Ø10.5mm PER FISSAGGIO CAVALLOTTO		sì	sì	sì
5	FORO Ø 8 mm PER FISSAGGIO CAVALLOTTO		sì	sì	sì
6	FORO Ø8 mm PER SPINA O VITE SQUADRETTA MULTIFUNZIONE		sì	sì	sì
7	ASOLA E FORO PASSAGGIO BINARIO RIPORTO SCORREVOLE GLOBAL		sì	no	no
8	SCARICO ACQUA 31X6		sì	no	sì
9	SPUNTATURE ALETTE PASSAGGIO ASTINA		sì	no	sì
10	PREDISPOSIZIONE MANIGLIA INCASSO SCORREVOLE GLOBAL		sì	no	no

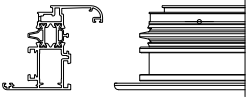
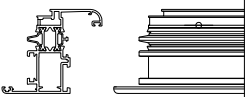
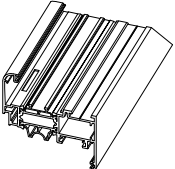
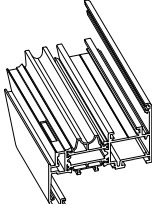
NUMERO LAVORAZIONE	DESCRIZIONE LAVORAZIONE	IMMAGINE LAVORAZIONE	LAVORAZIONE CON PUNZONATRICE MTC PL 3190601	LAVORAZIONE CON PUNZONATRICE MCT PL JOLLY	LAVORAZIONE CON PUNZONATRICE MCT PL 14460
11	FORO Ø 3 mm PER SPINA ACP5030 SQUADRETTA ACP 50153 , ACP 50154		no	sì	sì
12	FORO Ø 4 mm PER VITE ACP 50155 SQUADRETTA ACP 50153 , 50154		no	sì	sì
13	ASOLA INTERNA PER AREAZIONE ANTA		no	sì	sì
14	ASOLA ESTERNA PER AREAZIONE ANTA		no	sì	sì

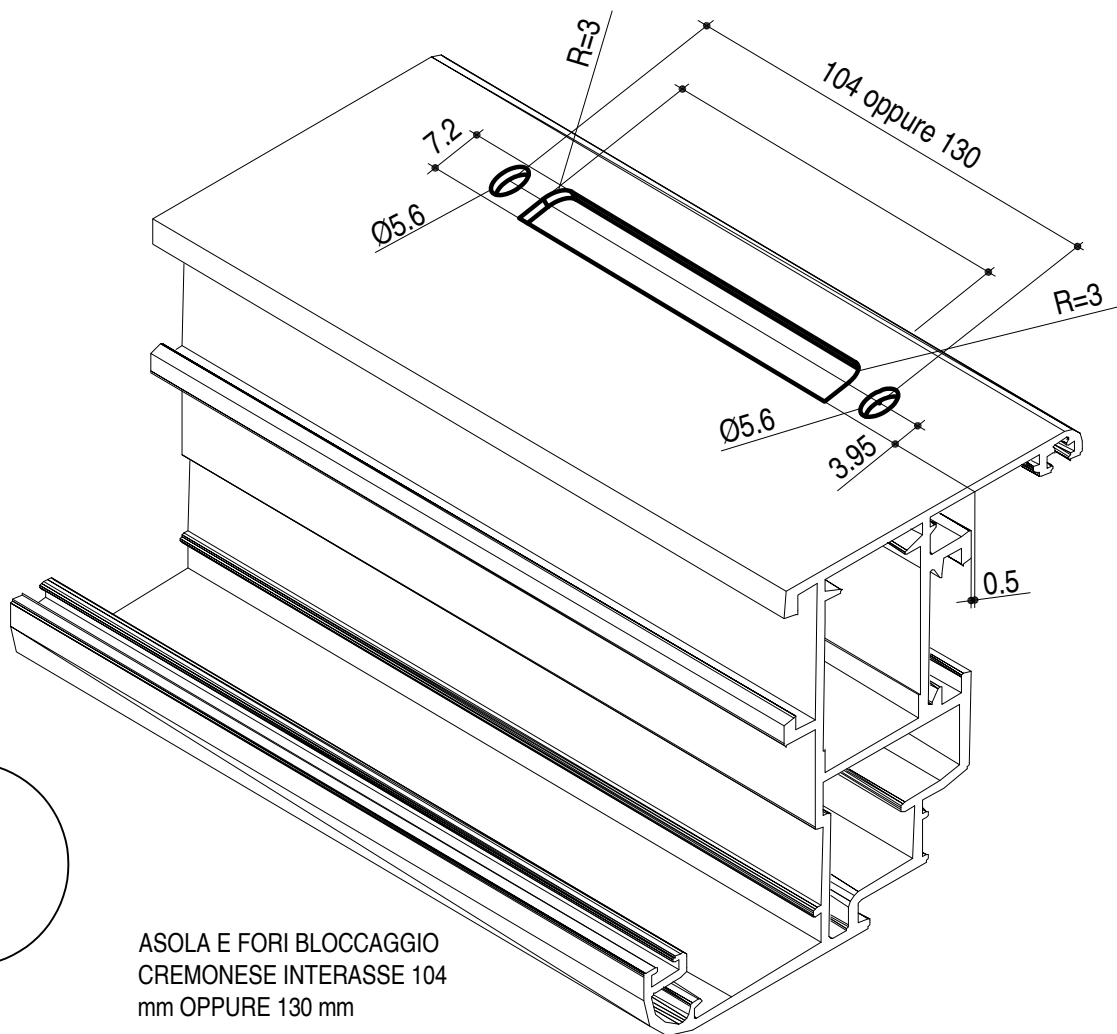

1

ASOLA E FORI BLOCCAGGIO
CREMONESE INTERASSE 104
mm OPPURE 130 mm

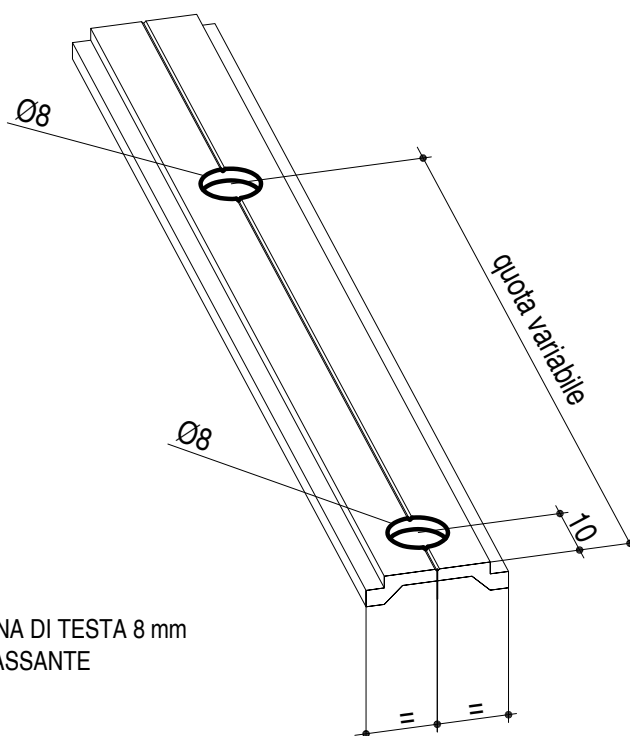

2

FORO ASTINA DI TESTA 8 mm
OPPURE PASSANTE

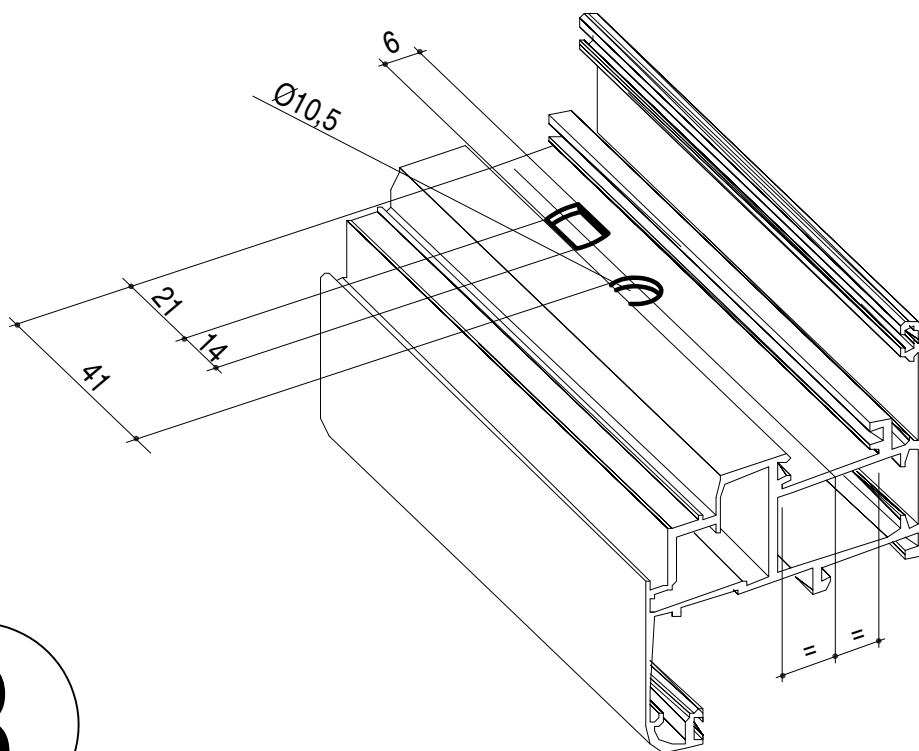

3

FORO $\text{Ø}10,5\text{mm}$ PER AGGANCIAMENTO E ASOLA 14x6 PER CHIAVE SQUADRETTA A PULSANTE

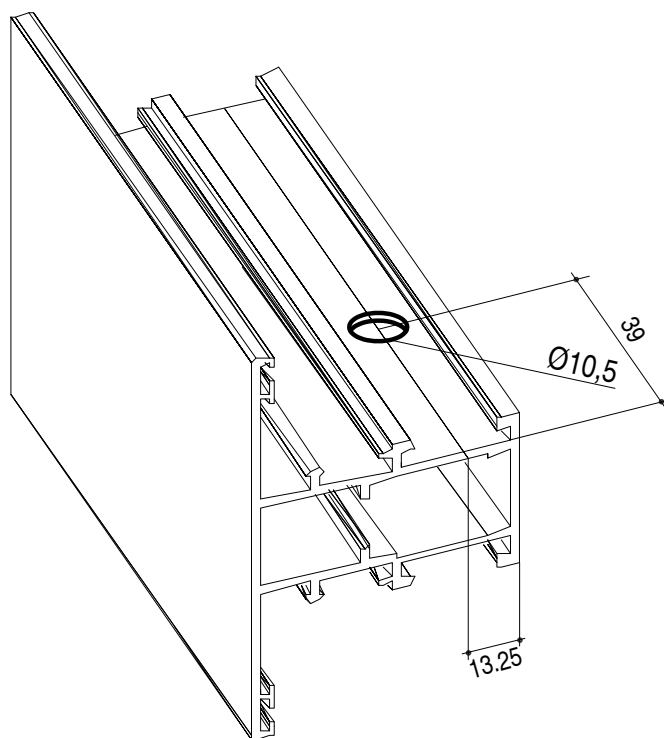

4

FORO $\text{Ø}10,5\text{mm}$ PER FISSAGGIO CAVALLOTTO

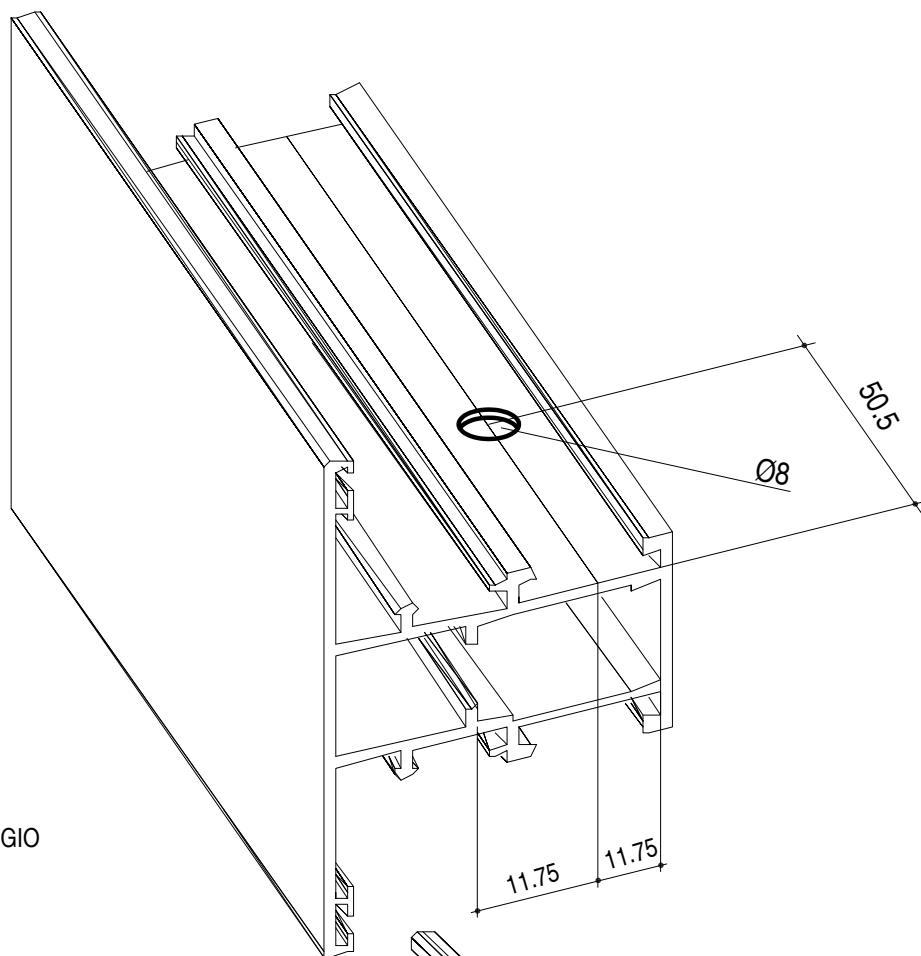

5

FORO Ø 8 mm PER FISSAGGIO
CAVALLOTTO

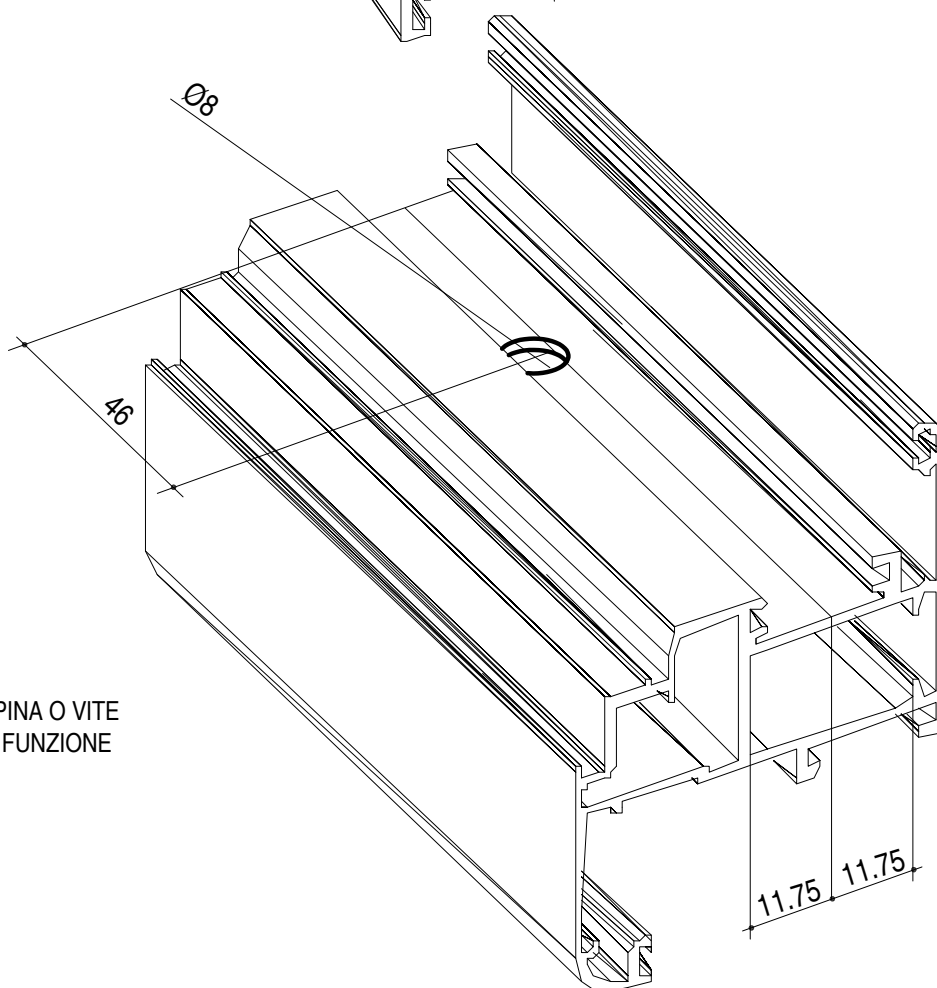

6

FORO Ø8 mm PER SPINA O VITE
SQUADRETTA MULTIFUNZIONE

7

ASOLA E FORO PASSAGGIO BINARIO RIPORTO SCORREVOLE GLOBAL

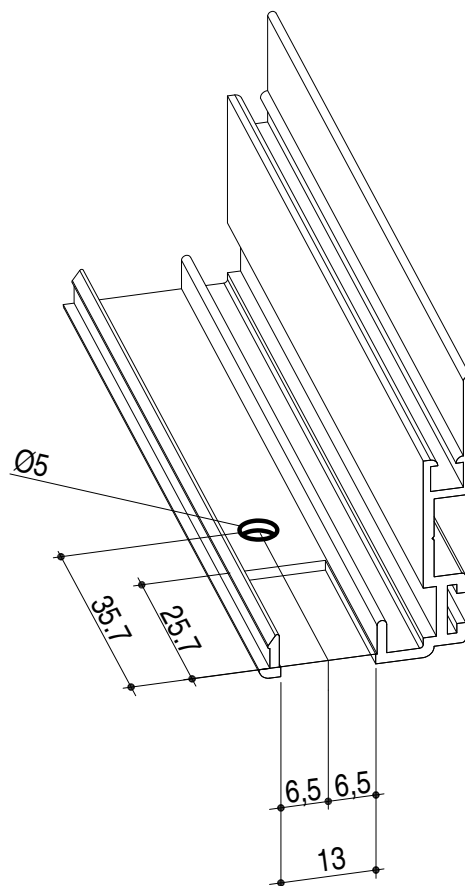

8

SCARICO ACQUA 31X6

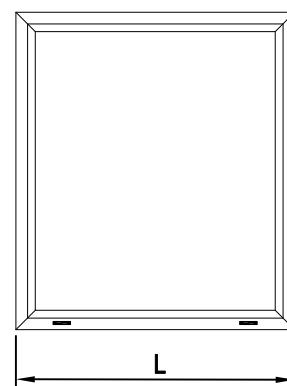
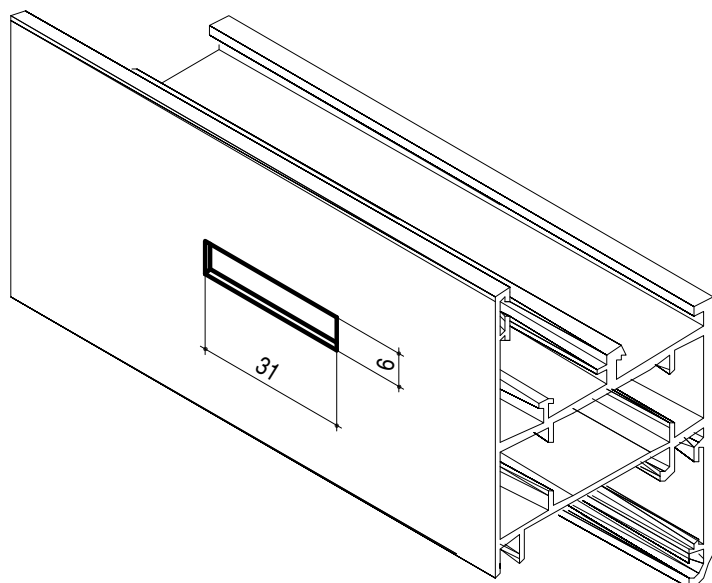

DIMENSIONI L (mm)	Q.TA' DRENAGGI
FINO A 1000	2
DA 1000 A 1500	3
OLTRE 1500	4

9

SPUNTATURE ALETTE PASSAGGIO ASTINA

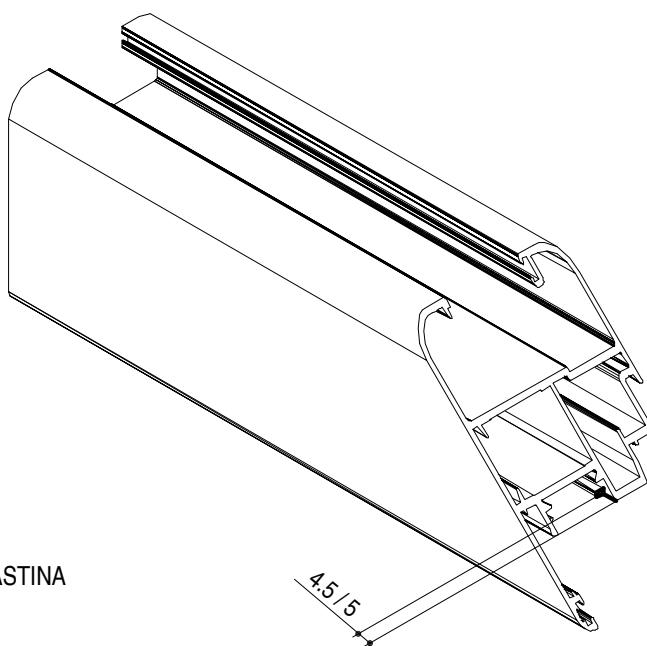

10

PREDISPOSIZIONE MANIGLIA
INCASSO SCORREVOLE GLOBAL

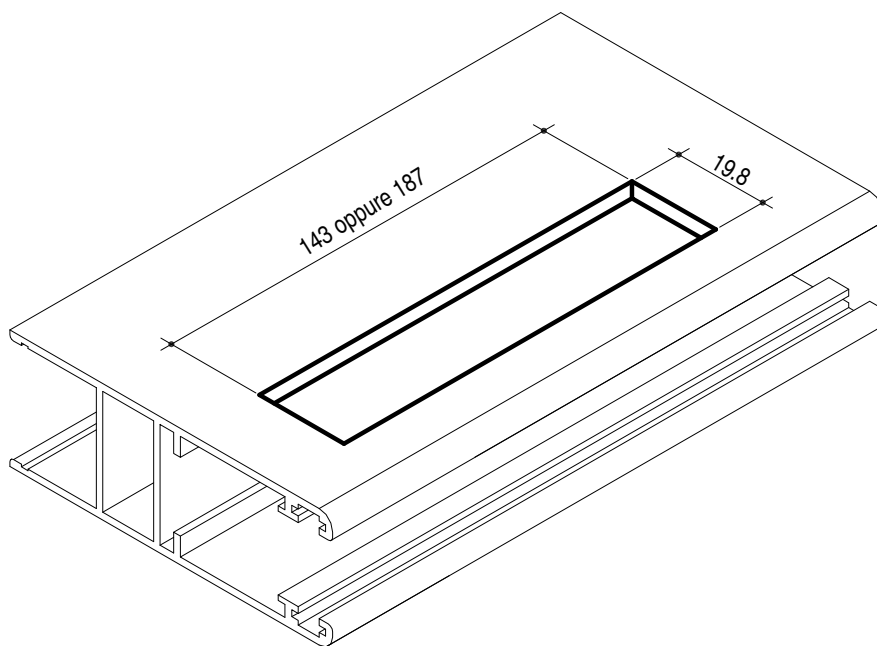

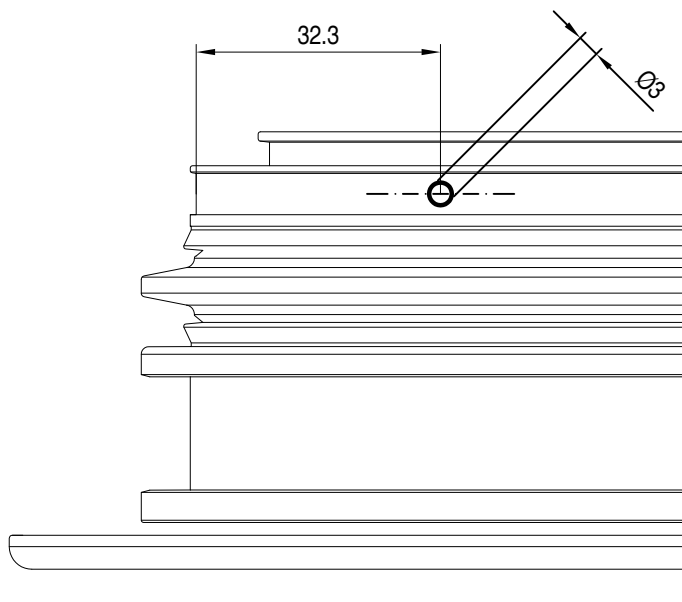
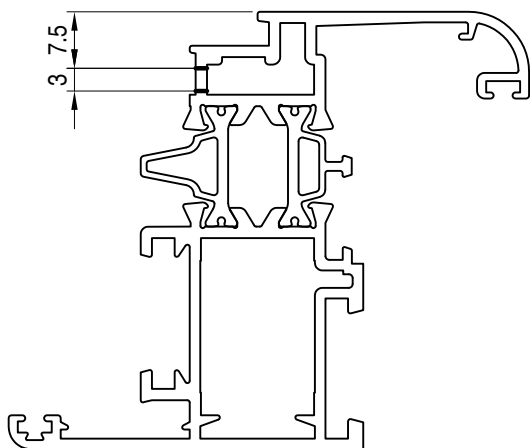

11

FORO $\varnothing 3$ mm PER
SPINA ACP 5030 SQUADRETTA ACP 50153 , ACP 50154

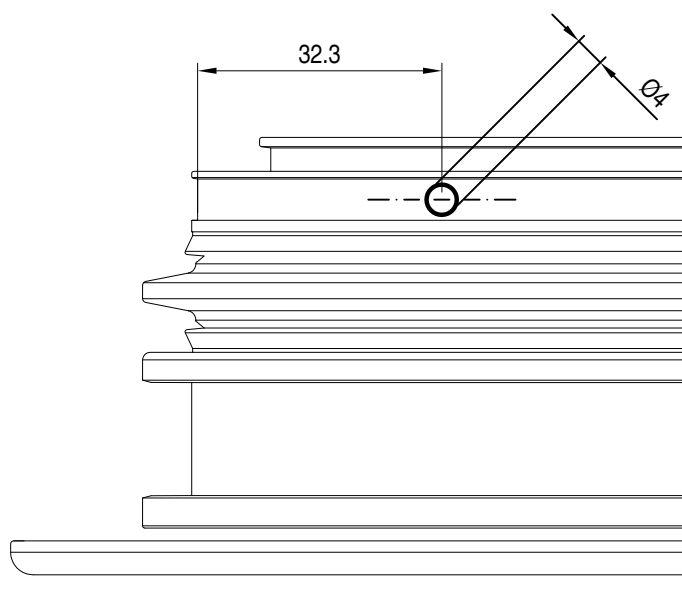
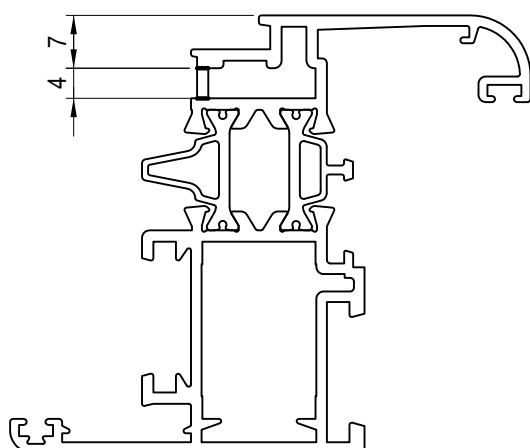

12

FORO $\varnothing 4$ mm PER
VITE ACP 50155 SQUADRETTA ACP 50153, ACP 50154

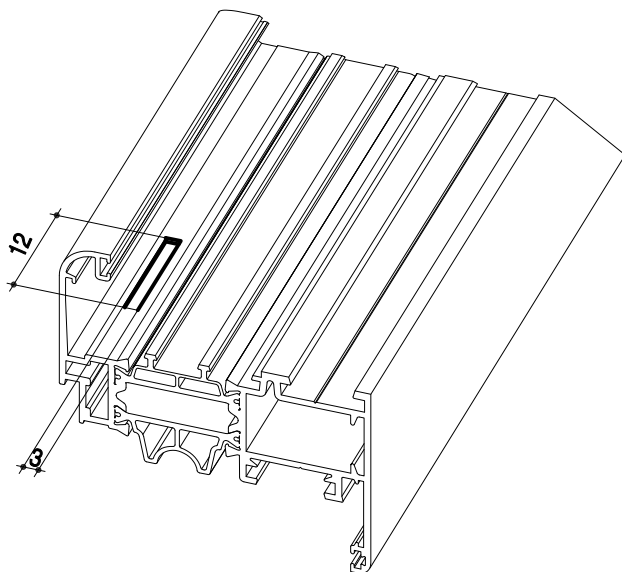

13

ASOLA INTERNA PER AREAIONE ANTA

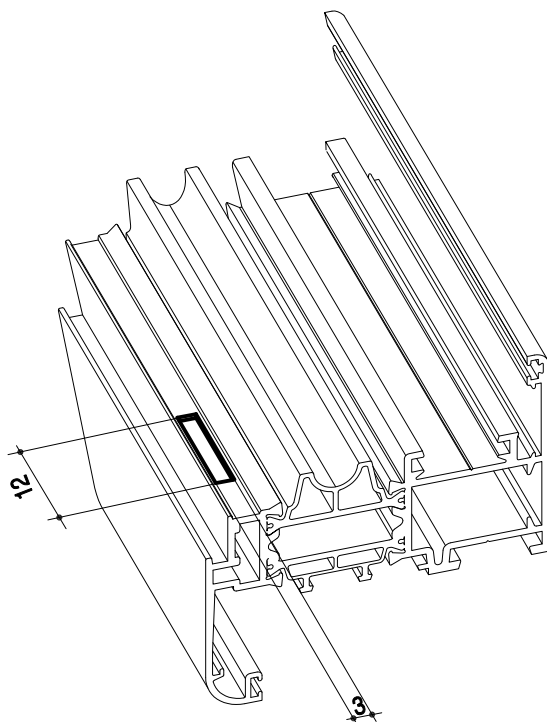
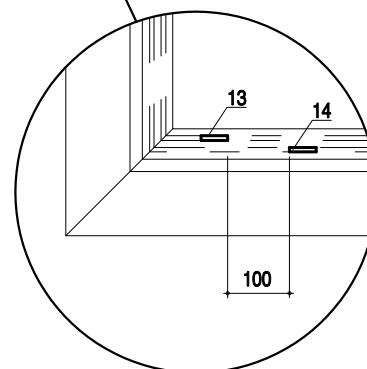
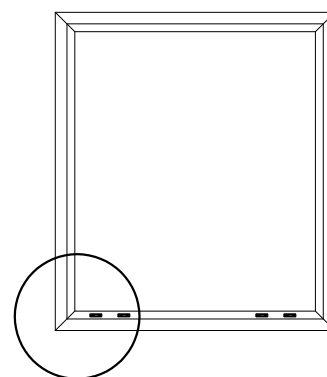

14

ASOLA ESTERNA PER AREAIONE ANTA

gruppo frese MCT PL 01 PT

questo gruppo fresa lavora tutti i profili della serie Planet 45 tranne quelli per il vetro ad infilare

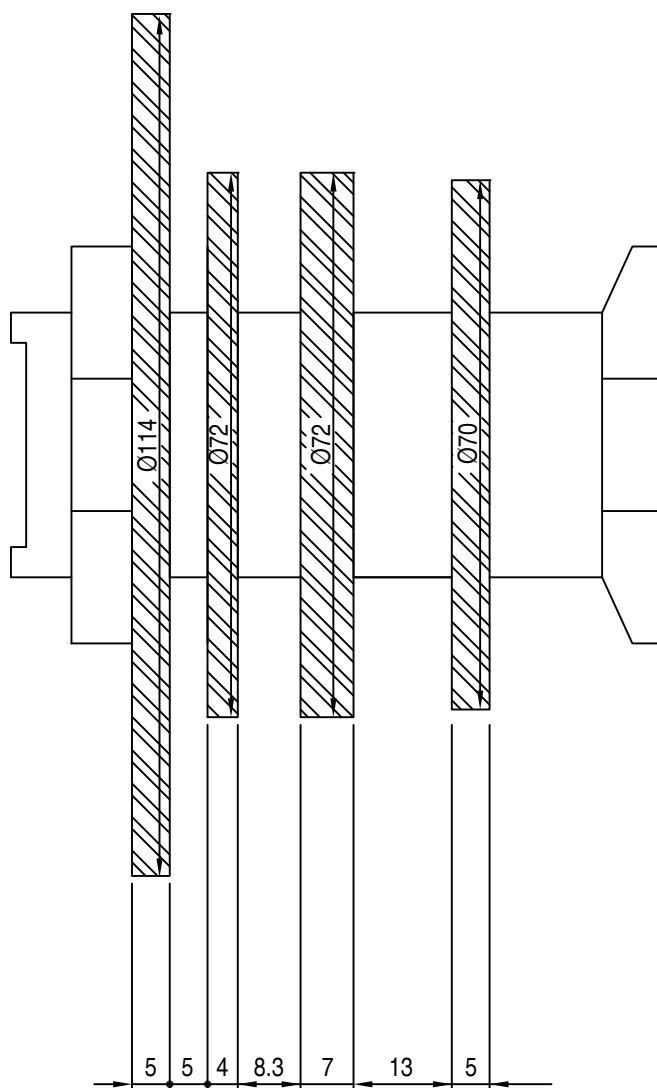
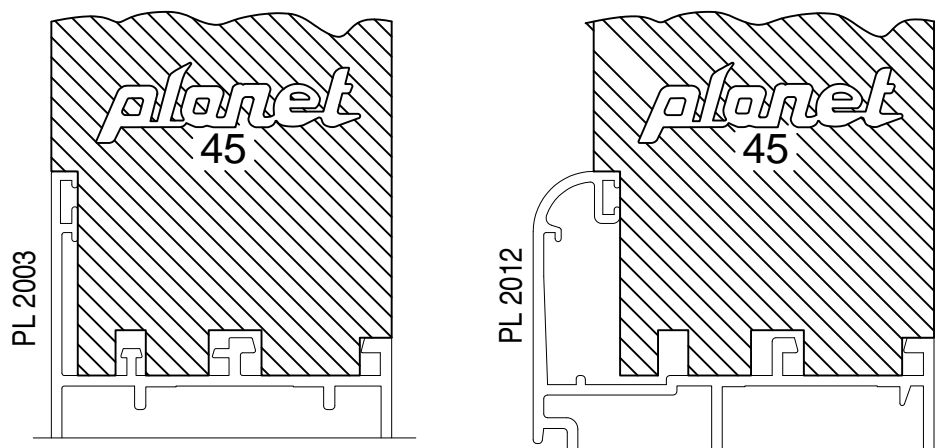

PROFILI LAVORABILI

- PL 20127
- PL 2006
- PL 2040
- PL 20138
- PL 2138
- PL 2041
- PL 2047

gruppo frese MCT PL 01 PT

questo gruppo fresa lavora esclusivamente i profili per le ante lisce da 53mm della serie Planet 45

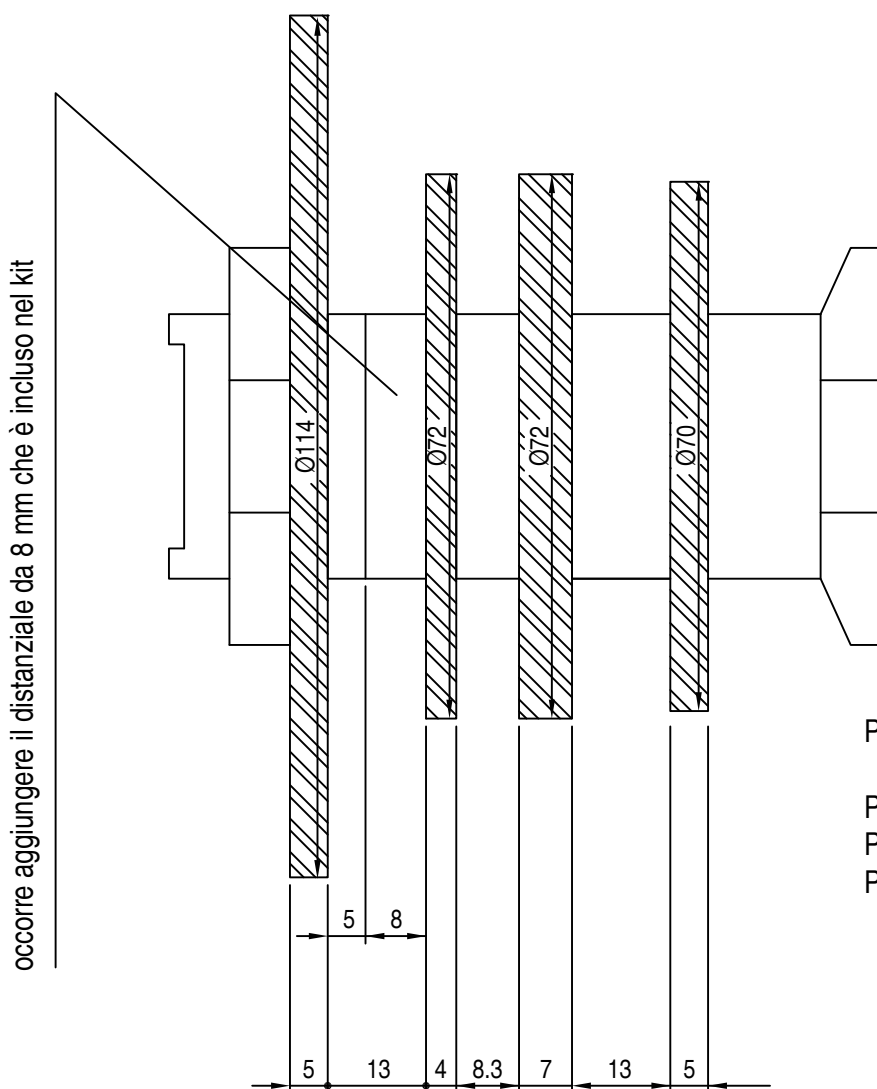
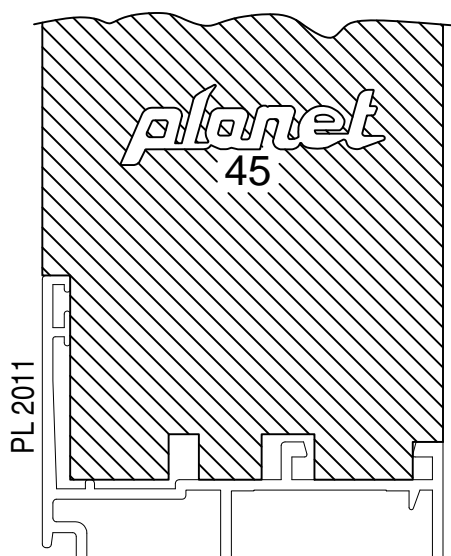

PROFILI LAVORABILI

- PL 2096
- PL 2006
- PL 2048

gruppo frese MCT PL 02 PT

questo gruppo fresa lavora esclusivamente i profili vetro infilare per le ante modanate PL21151, PL 2151 e PL 2028

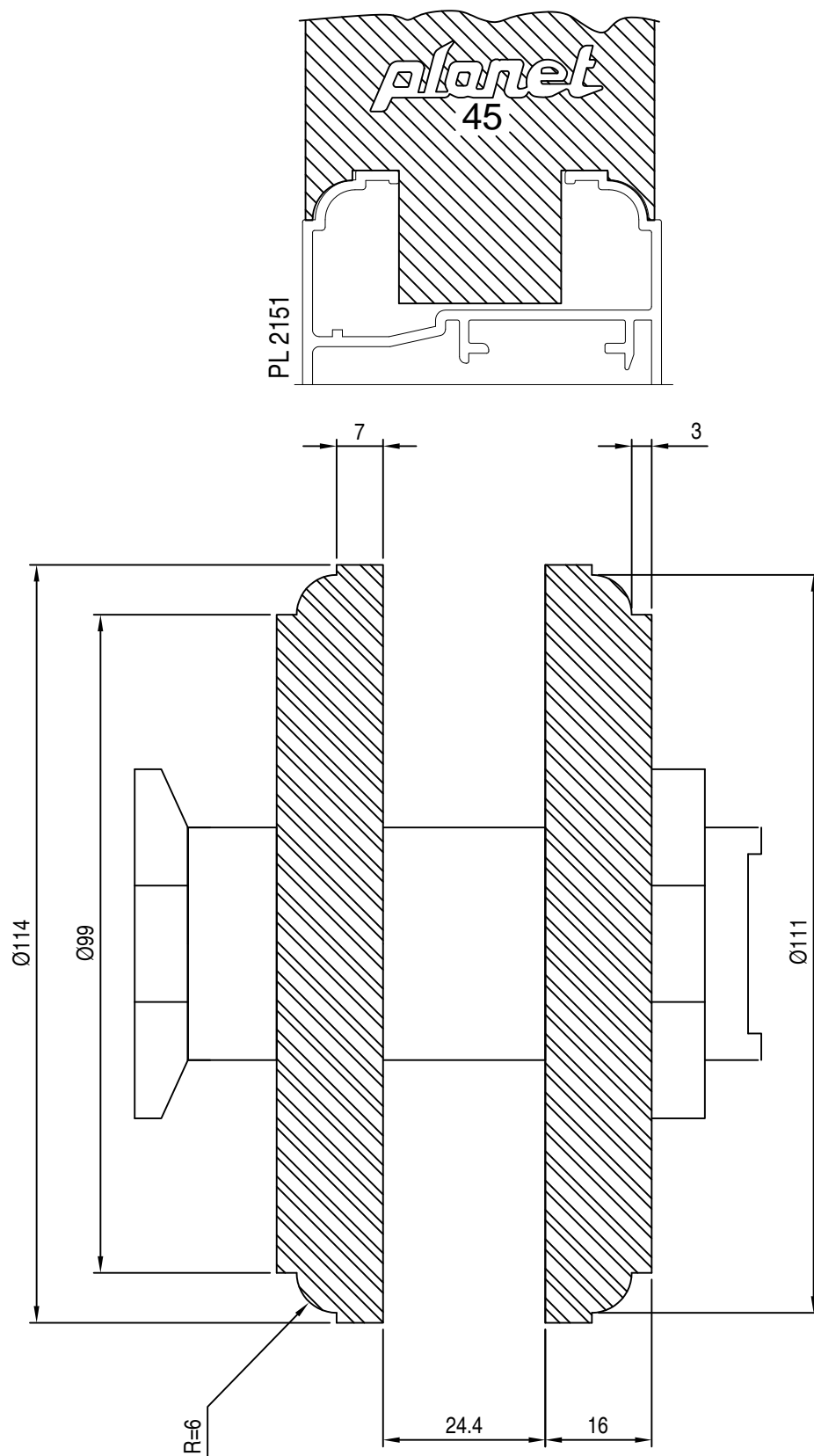

PROFILI LAVORABILI

- PL 21148
- PL 2152
- PL 2148
- PL 2153
- PL 2062

gruppo frese MCT PL 06 PT

Gruppo frese per serie Planet 45 solo vetro ad infilare (spazio vetro 25 mm)

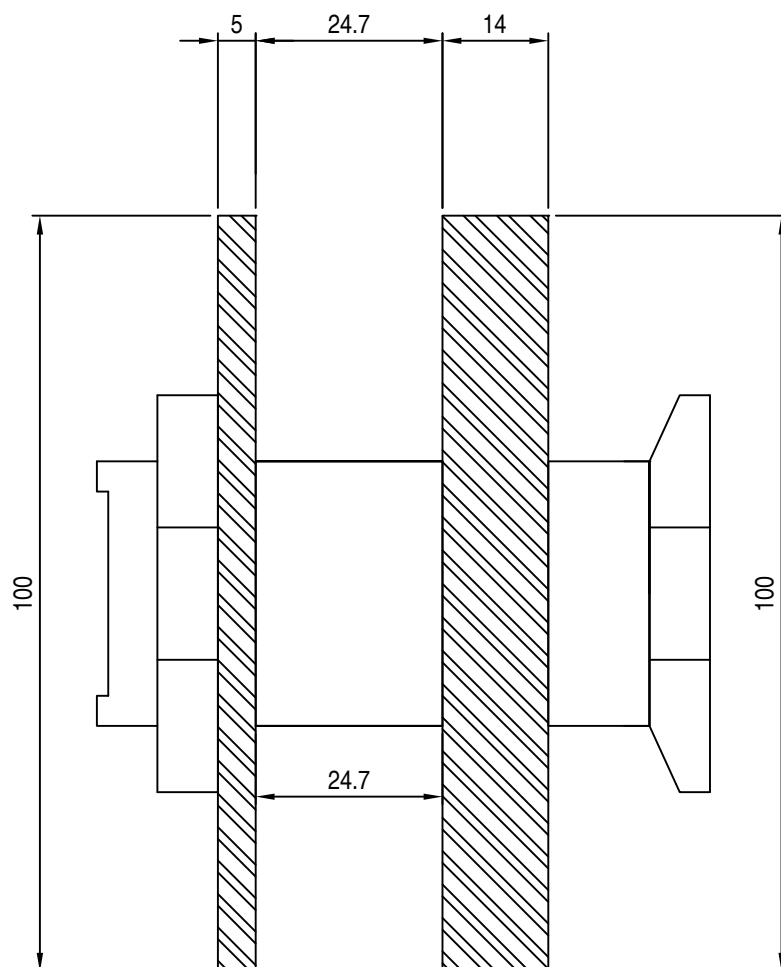
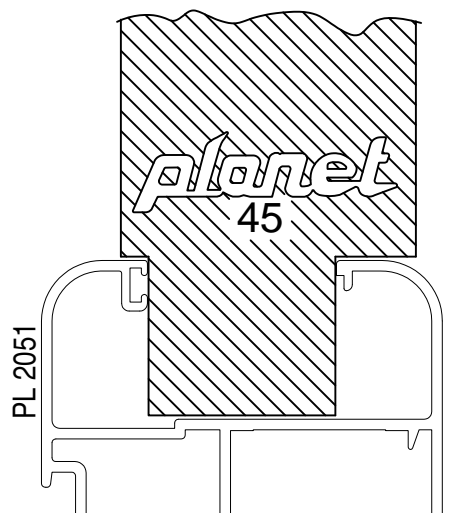

PROFILI LAVORABILI

- PL 2052
- PL 2153
- PL 20148
- PL 20248

gruppo frese MCT PL 10 PT

Gruppo frese per serie Planet 45 porte interne

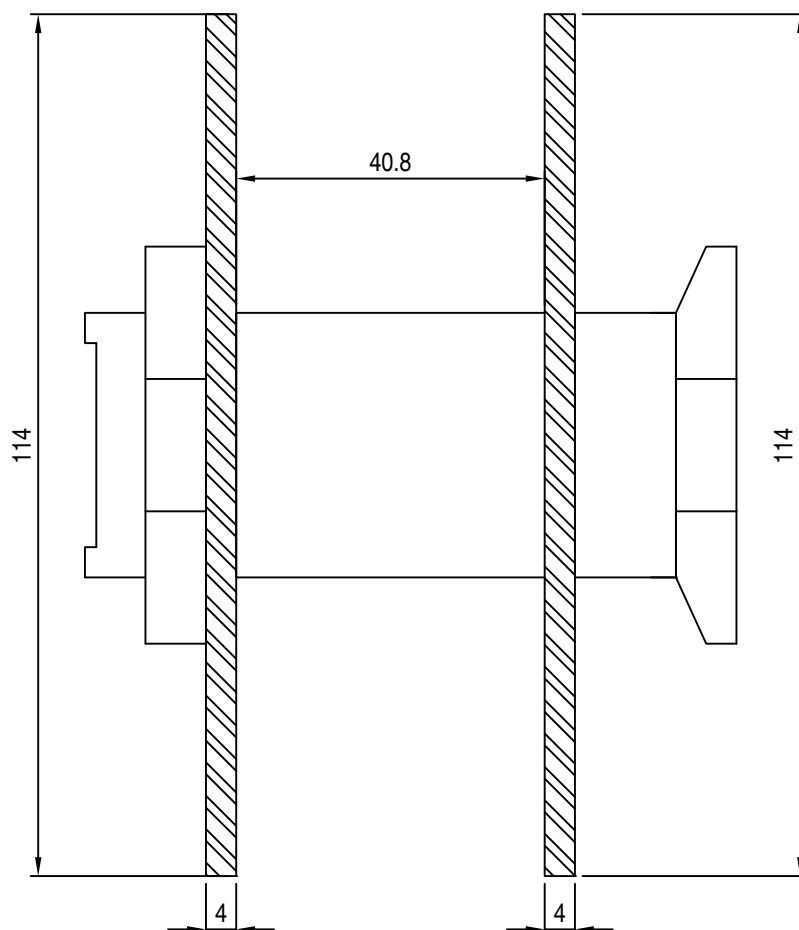
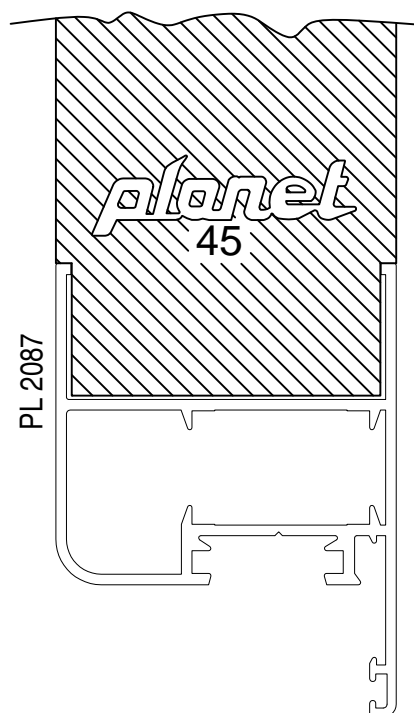
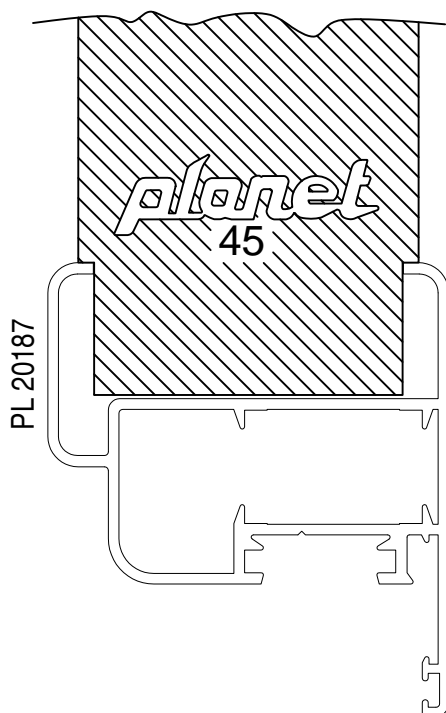

PROFILI LAVORABILI

PL 20152

lavorazione spalla monoblocco

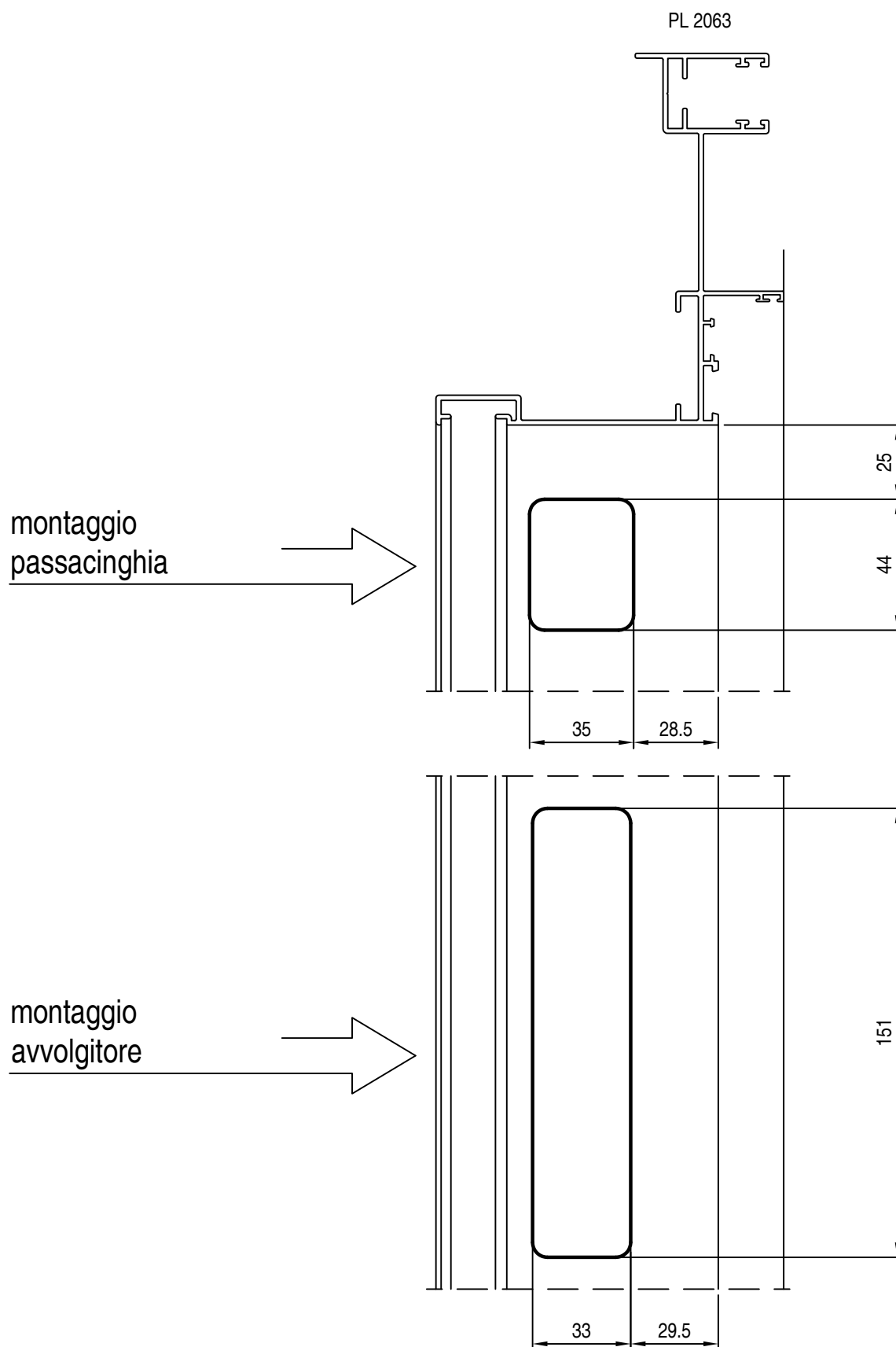

Applicazione ACP 5801 - ACP 5802

Foratura pre-spina tramite punzonatrice. - $\varnothing = 8$ mm. (lavorazione n° 6) .

Inserire la squadretta ACP 5801 e chiudere l'angolo scegliendo tra le seguenti opzioni:

- 1) cianfrinatura tramite l'apposito Kit
- 2) spinatura tramite spina ACP 5800
- 3) avvitatura con vite ACP 5001

INTERASSE FORO :mm 46

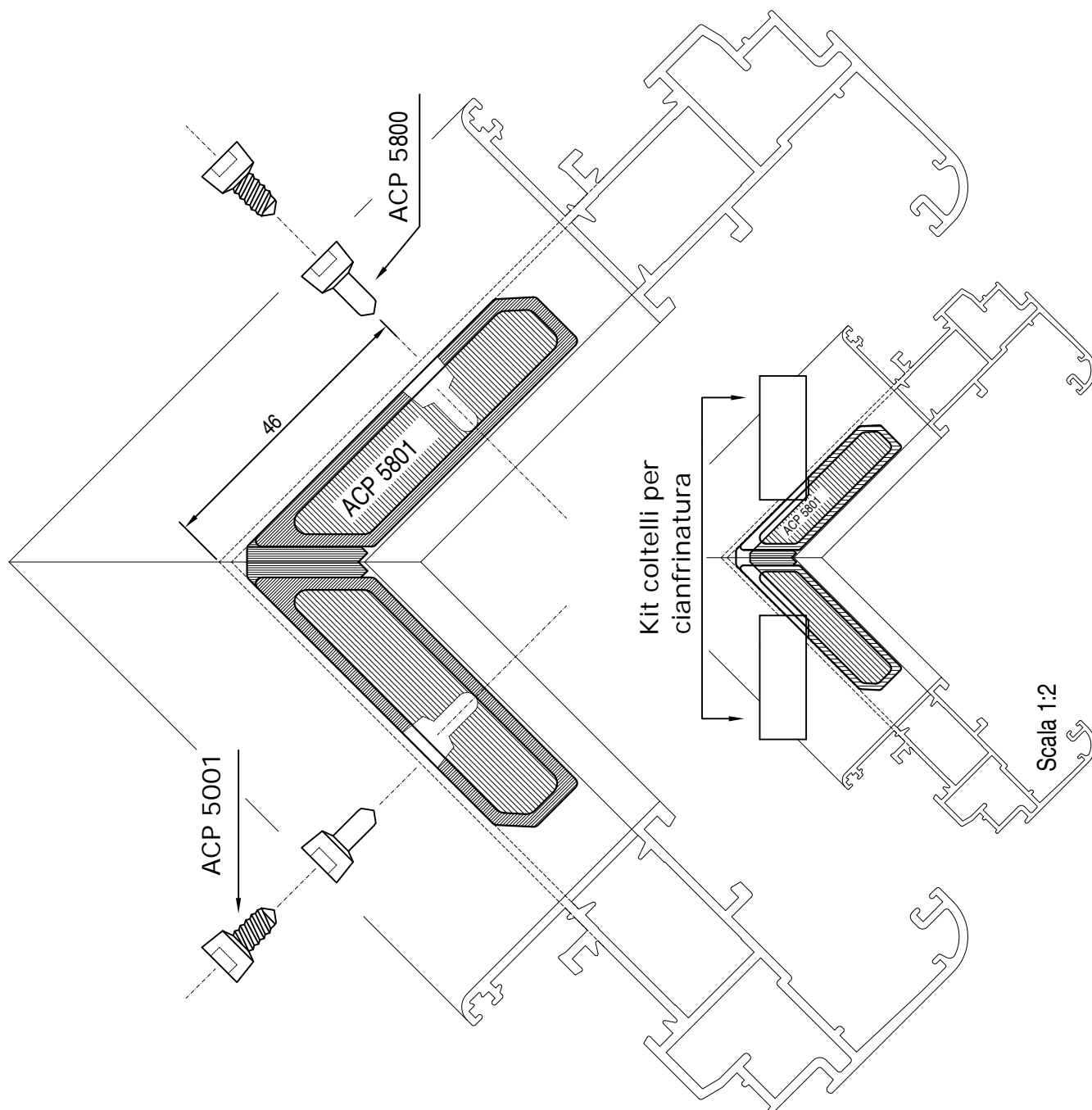

Lavorazione fori per montaggio squadretta maggiorata angolo variabile ACP 5506



Procedura per ACP 5506

- Stabilito l'angolo di taglio del profilo, misurare la quota B
- Eseguire il calcolo come suggerito nella formula in basso
- Visto l'ampio campo di regolazione delle squadrette la misura ottenuta può essere arrotondata + o - al mm

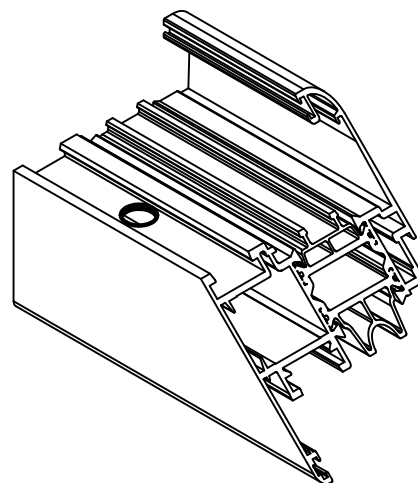
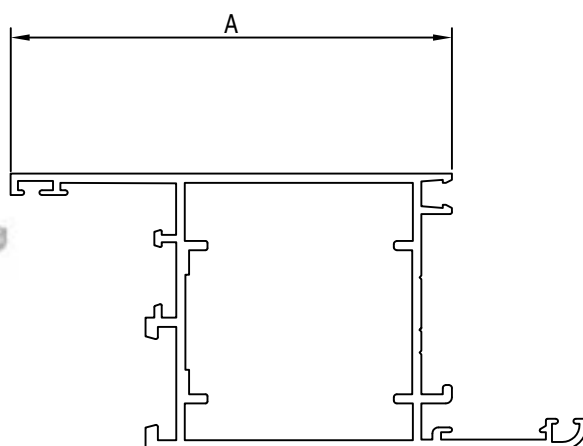
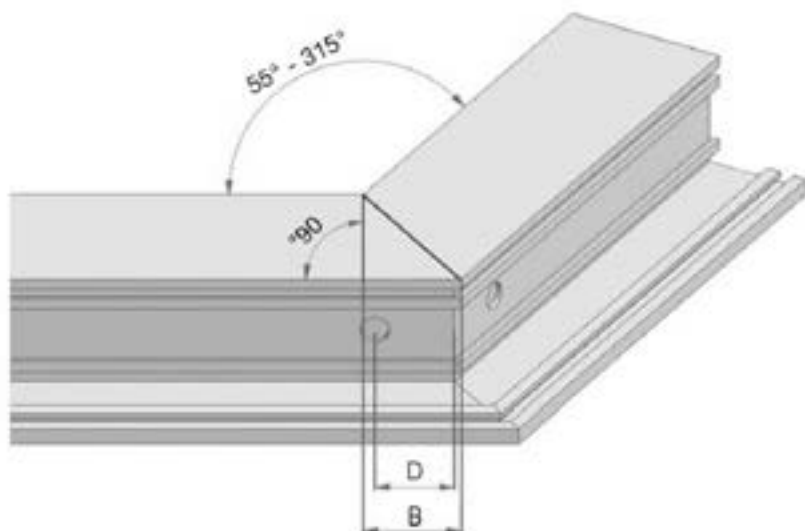

Per calcolare l'asse di foratura

$$D = 25 + (7 \times B \div A)$$

A = larghezza profilo

B = proiezione (a 90°) vertice interno su lato esterno

Esempio con B = 35 mm A = 50 mm

$$D = 25 + (7 \times 35 \div 50) = 30 \text{ mm}$$

Lavorazione fori per montaggio squadrette angolo variabile ACP 5504 / ACP 5805 :

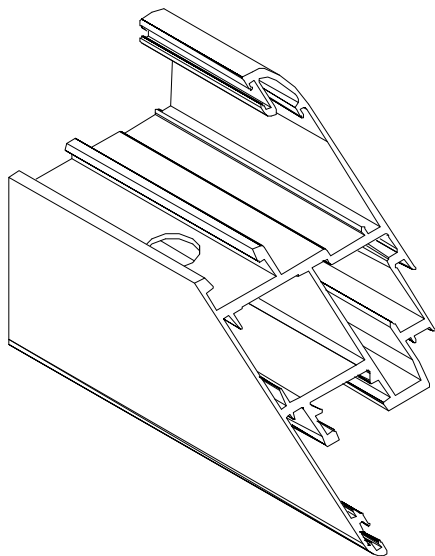

Procedura per ACP 5504

- Stabilito l'angolo di taglio del profilo, misurare la quota A o determinarla in linea teorica applicando la seguente formula $A = B \times \tan(\text{alfa})$
- Sommare o detrarre al coefficiente C la metà della quota A (prima determinata) per ottenere la distanza di foratura X1 esterna oppure X2 per la distanza interna
- Visto l'ampio campo di regolazione delle squadrette la misura ottenuta può essere arrotondata + o - al mm

Procedura per ACP 5805

- Per questa squadretta valgono le stesse regole per il calcolo di A, mentre per X1 il coefficiente da aggiungere è sempre 41 mm

PERTANTO: $X1 = A + 41$

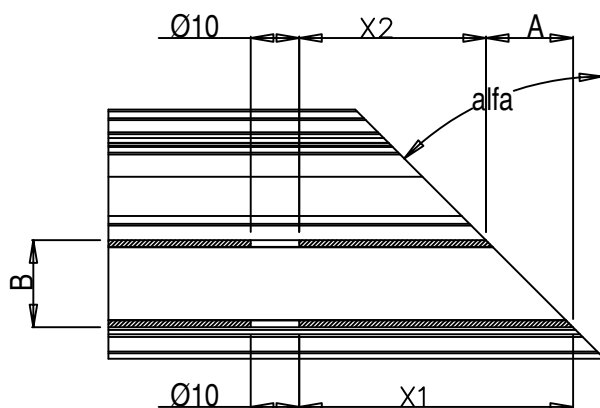

$$\begin{aligned} \text{Angolo} &= \text{alfa} \\ A &= B \times \tan(\text{alfa}) \\ C &= 65 \\ X1 &= C + (A/2) \\ X2 &= C - (A/2) \end{aligned}$$

Esempio con angolo di taglio $\text{alfa} = 55^\circ$

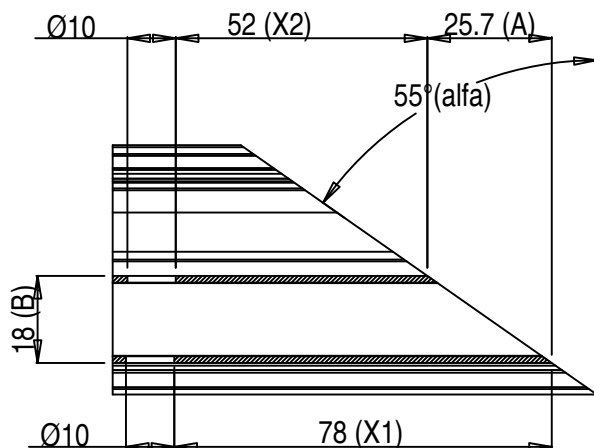

$$\begin{aligned} \text{Angolo} &= 55 \\ A &= 18 \times (\tan \text{ di } 55) \\ C &= 65 \text{ (art. 0910.10)} \\ X1 &= 65 + (25.71/2) = 77.85 \text{ circa} \\ X2 &= 65 - (25.71/2) = 52.15 \text{ circa} \\ &\text{arrotondare} \\ X1 &= 78 \\ X2 &= 52 \end{aligned}$$

Lavorazione regolo a muro

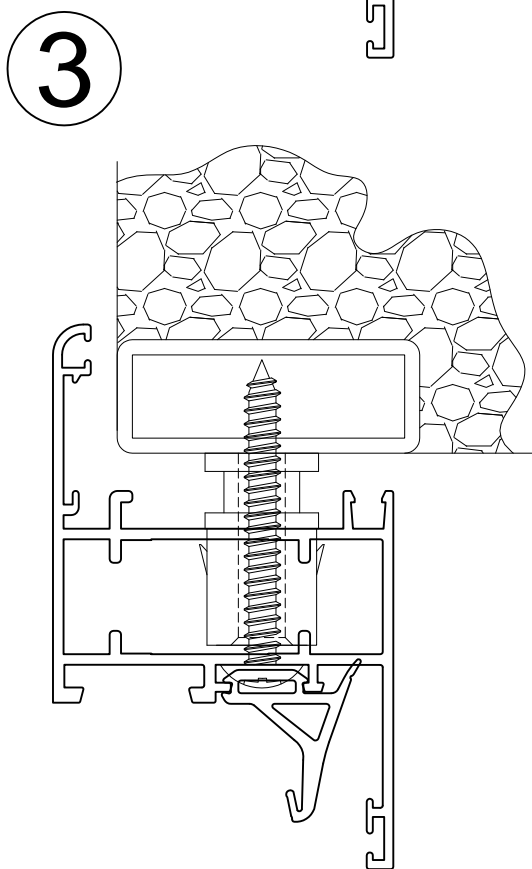
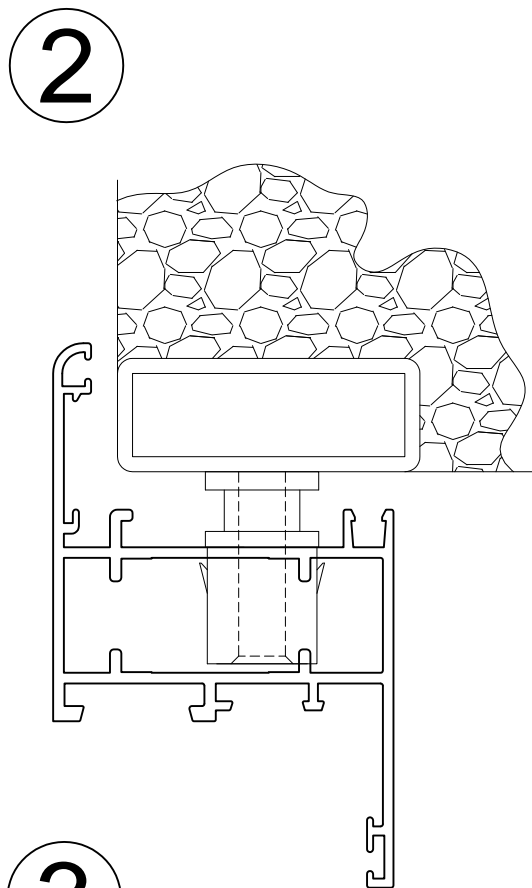
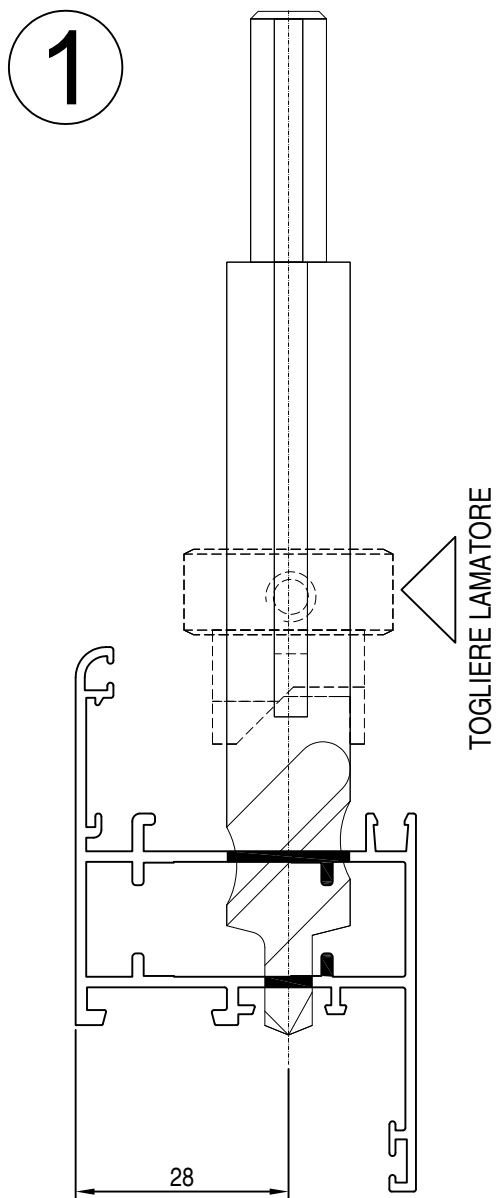

- ① FORARE LA TUBOLARITA' DEL TELAIO CON FRESA A SCALINO 7/15mm AD UNA DISTANZA DI 28 mm DALLA BATTUTA INTERNA
- ② INSERIRE IL REGOLO NELLA SUA SEDE
- ③ TAGLIARE LA GUARNIZIONE SOTTO IN CORRISPONDENZA DELLA TESTA DELLA VITE

Lavorazione taglio astina per chiusura battente

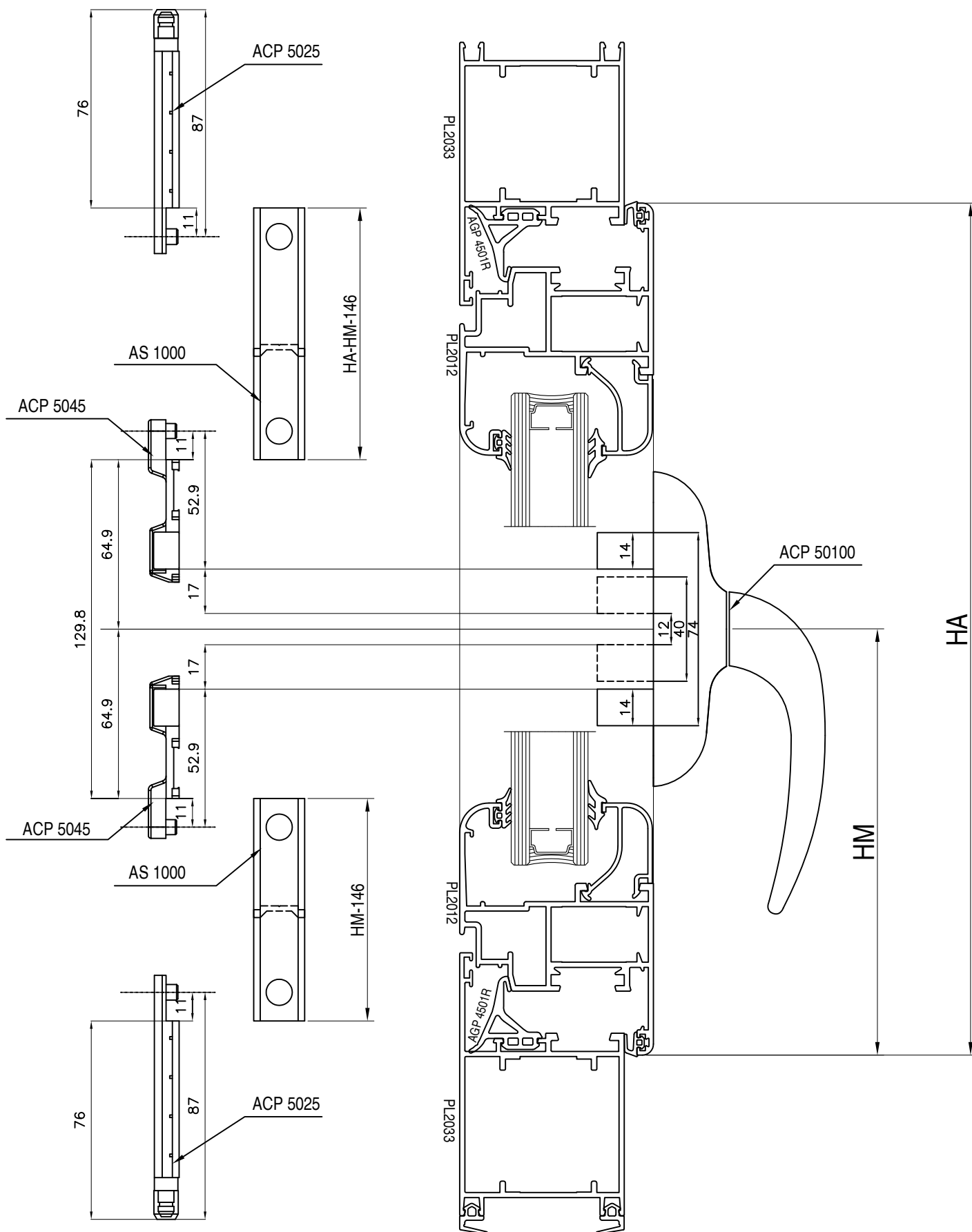

Montaggio tappo riporto centrale

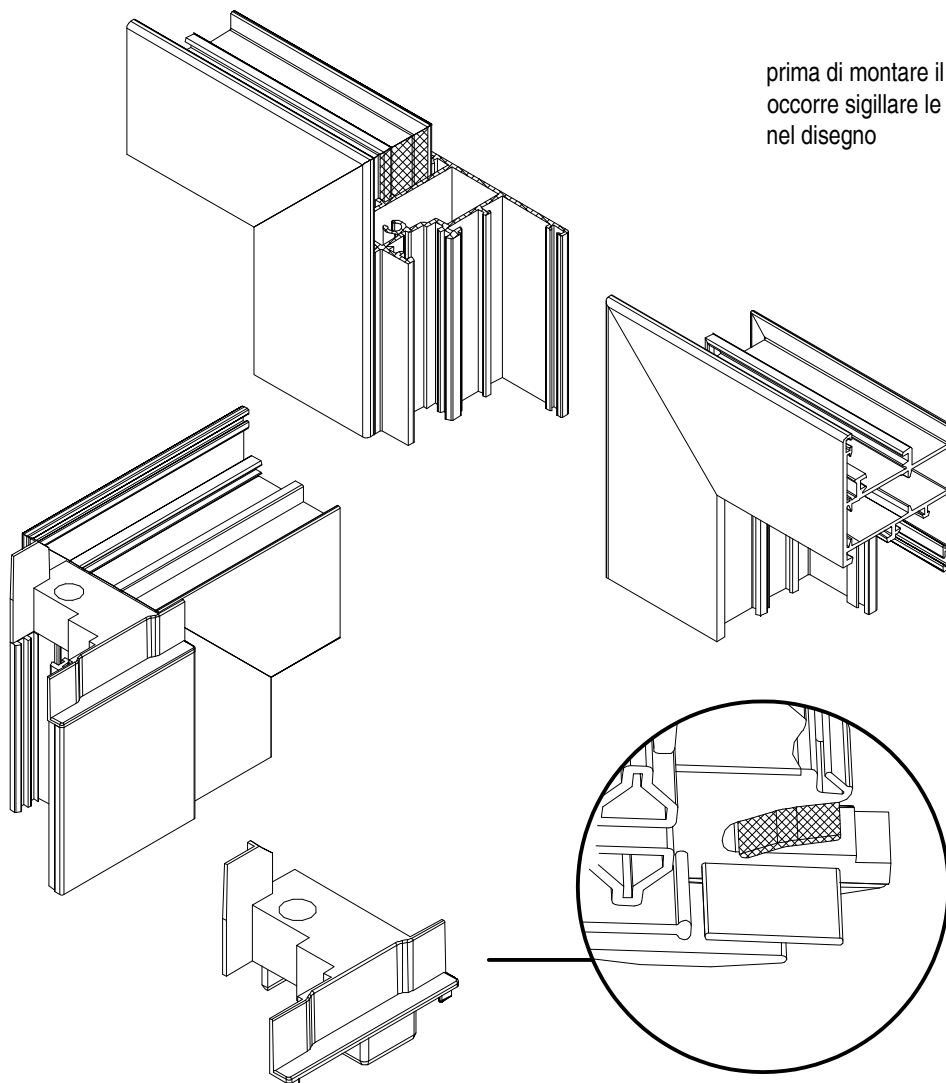

prima di montare il tappo riporto centrale
occorre sigillare le zone evidenziate in nero
nel disegno

nel caso di versione giunto aperto, dopo aver
inserito il tappo, accostare la pinna centrale
incollando la zona di contatto

montaggio angolo vulcanizzato

1

prima di montare l'angolo vulcanizzato
occorre sigillare la sede della guarnizione
nell'angolo

2

dopo aver montato l'angolo vulcanizzato
accostare le pinne incollando le zone di
contatto

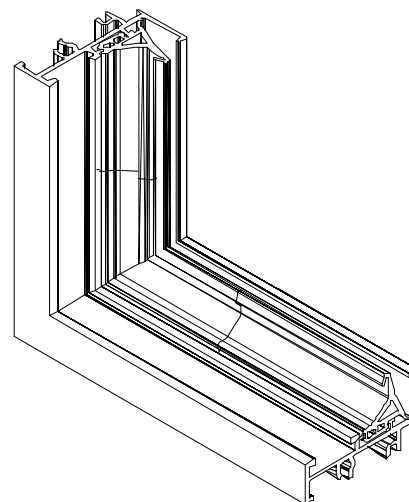
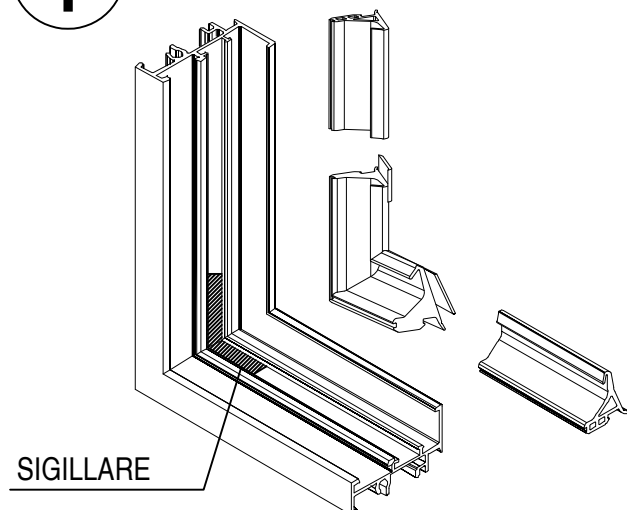

Montaggio angolino fermavetri

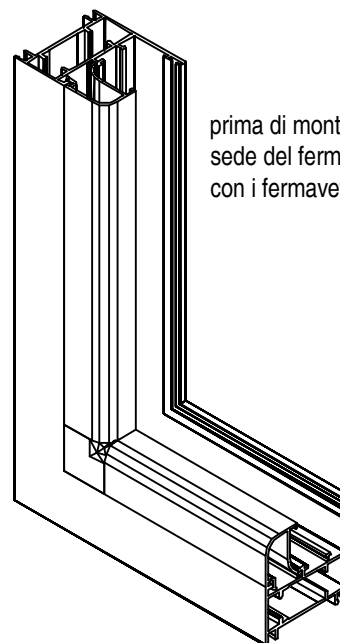
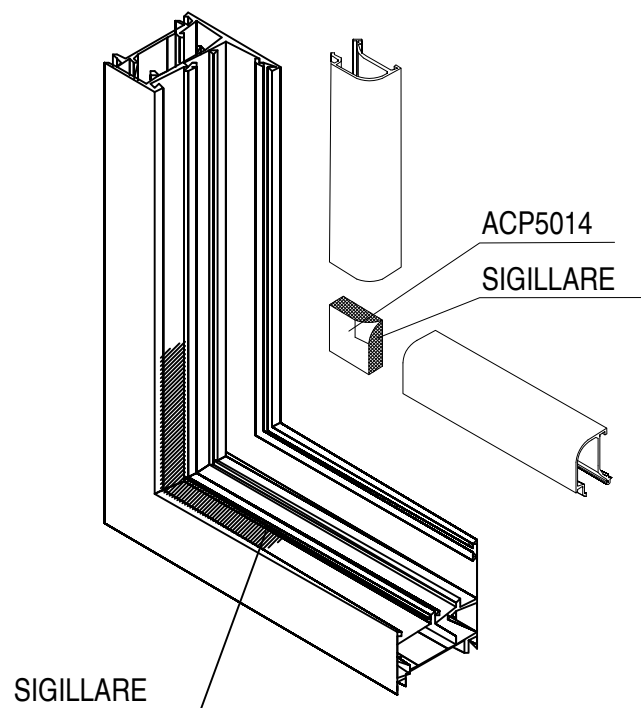

prima di montare l'angolino occorre sigillare la sede del fermavetro nell'angolo e le giunzioni con i fermavetri

Montaggio piastrino antirollio

questo accessorio offre una stabilità migliore alla cremonese, viene applicato al posto del piastrino in dotazione della cremonese stessa e venduto a parte col codice ACP 50101, per alcuni profili occorre adottare delle viti di fissaggio più lunghe

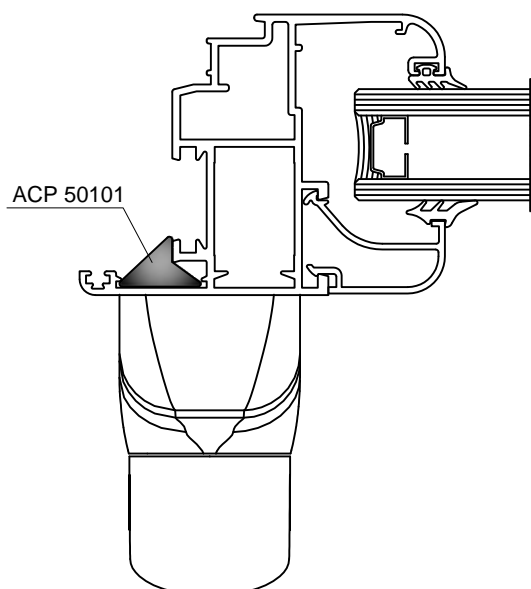

applicazione cerniere strong ACP 9938 per telai complanari interni

PROFILI PL 20102 + PL 2337

Alsystem
s.r.l.
Via G. Reiss Romoli, 267
10148 Torino
Italy

EN1935-2002

11

GRAFICO PER IL CALCOLO DEL PESO MASSIMO EFFETTIVO DELL'ANTA
CHART FOR CALCULATING THE ACTUAL MAX. SASH WEIGHT

3000	1	1	1	1	1	1	1	1	1	0,93	0,84	0,76		
2900	1	1	1	1	1	1	1	1	1	0,88	0,80	0,74		
2800	1	1	1	1	1	1	1	1	0,93	0,83	0,76	0,71		
2700	1	1	1	1	1	1	1	1	0,88	0,79	0,72	0,68		
2600	1	1	1	1	1	1	1	1	0,93	0,83	0,75	0,69	0,65	
2500	1	1	1	1	1	1	1	1	0,87	0,78	0,71	0,67	0,63	
2400	1	1	1	1	1	1	1	0,93	0,81	0,74	0,68	0,64	0,61	
2300	1	1	1	1	1	1	1	0,85	0,76	0,70	0,65	0,61	0,59	
2200	1	1	1	1	1	1	1	0,91	0,80	0,72	0,67	0,63	0,59	0,57
2100	1	1	1	1	1	1	0,85	0,75	0,68	0,64	0,60	0,57	0,55	
2000	1	1	1	1	0,91	0,79	0,71	0,65	0,61	0,58	0,55	0,53		
1900	1	1	1	1	0,83	0,73	0,67	0,62	0,58	0,56	0,53	0,52		
1800	1	1	1	1	0,90	0,77	0,69	0,63	0,59	0,56	0,54	0,52	X	
1700	1	1	1	0,82	0,71	0,65	0,60	0,57	0,54	0,52	X	X		
1600	1	1	0,89	0,75	0,67	0,61	0,57	0,54	0,52	X	X	X		
1500	1	1	0,80	0,69	0,63	0,58	0,55	0,52	X	X	X	X		
1400	1	0,88	0,73	0,64	0,59	0,55	0,52	X	X	X	X	X		
1300	1	0,78	0,67	0,60	0,56	0,52	X	X	X	X	X	X		
1200	1	0,78	0,67	0,60	0,56	0,52	X	X	X	X	X	X		
	L	600	700	800	900	1000	1100	1200	1300	1400	1500	1600	1700	1800
		Larghezza anta (mm) - Wing width (mm)												

PORTATE MASSIME - MAXIMUM LOADS

100 kg

120 kg

100 kg

70 kg

CON FRENO IN APERTURA
WITH OPENING BRAKE

X Dimensioni non realizzabili
Not possible dimensions

applicazione cerniere strong ACP 9918 per telai piani

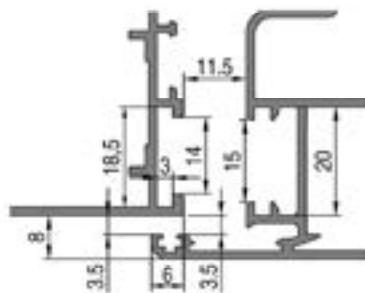
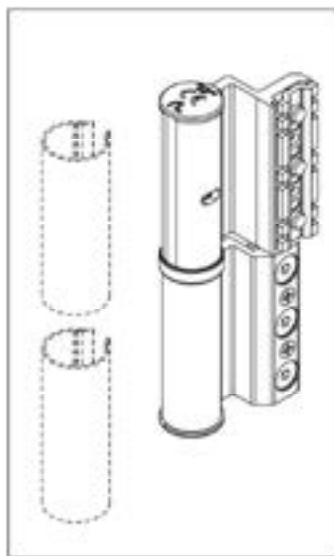

PROFILI PL 2033 + PL 2337

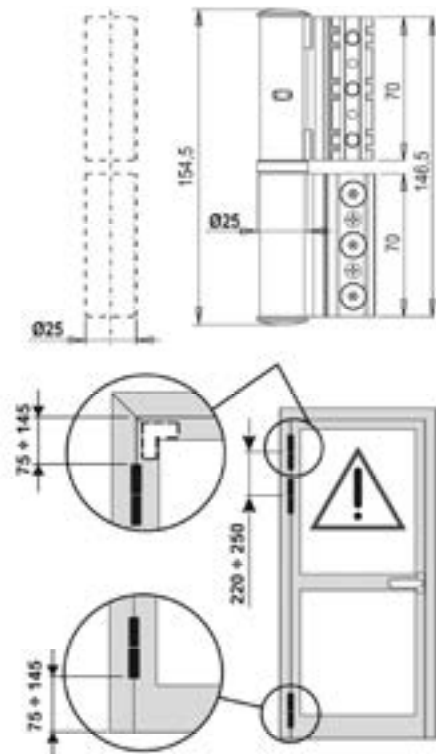

CE		Alsistem s.r.l. Via G. Reiss Romoli, 267 10148 Torino Italy	11
0757	EPR-209-11-009		
EN1935:2002		4 7 8 0 1 4 1 13	

GRAFICO PER IL CALCOLO DEL PESO MASSIMO EFFETTIVO DELL'ANTA
CHART FOR CALCULATING THE ACTUAL MAX. SASH WEIGHT

3000	1	1	1	1	1	1	1	1	1	0.93	0.84	0.76	
2900	1	1	1	1	1	1	1	1	1	0.88	0.80	0.74	
2800	1	1	1	1	1	1	1	1	0.93	0.83	0.76	0.71	
2700	1	1	1	1	1	1	1	1	0.88	0.79	0.72	0.68	
2600	1	1	1	1	1	1	1	0.93	0.83	0.75	0.69	0.65	
2500	1	1	1	1	1	1	1	0.87	0.78	0.71	0.67	0.63	
2400	1	1	1	1	1	1	0.93	0.81	0.74	0.68	0.64	0.61	
2300	1	1	1	1	1	1	0.85	0.76	0.70	0.65	0.61	0.59	
2200	1	1	1	1	1	0.91	0.80	0.72	0.67	0.63	0.59	0.57	
2100	1	1	1	1	1	0.85	0.75	0.68	0.64	0.60	0.57	0.55	
2000	1	1	1	1	0.91	0.79	0.71	0.65	0.61	0.58	0.55	0.53	
1900	1	1	1	1	0.83	0.73	0.67	0.62	0.58	0.56	0.53	0.52	
1800	1	1	1	0.90	0.77	0.69	0.63	0.59	0.56	0.54	0.52	X	
1700	1	1	1	0.82	0.71	0.65	0.60	0.57	0.54	0.52	X	X	
1600	1	1	0.89	0.75	0.67	0.61	0.57	0.54	0.52	X	X	X	
1500	1	1	0.80	0.69	0.63	0.58	0.55	0.52	X	X	X	X	
1400	1	0.88	0.73	0.64	0.59	0.55	0.52	X	X	X	X	X	
1300	1	0.78	0.67	0.60	0.56	0.52	X	X	X	X	X	X	
1200	1	0.78	0.67	0.60	0.56	0.52	X	X	X	X	X	X	
	600	700	800	900	1000	1100	1200	1300	1400	1500	1600	1700	1800
	L Lunghezza anta (mm) - Wing width (mm)												

PORTATE MASSIME - MAXIMUM LOADS		
120 kg	150 kg	120 kg
	CON FRENO IN APERTURA WITH OPENING BRAKE	
80 kg		

X Dimensioni non realizzabili
Not possible dimensions

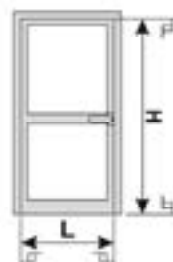

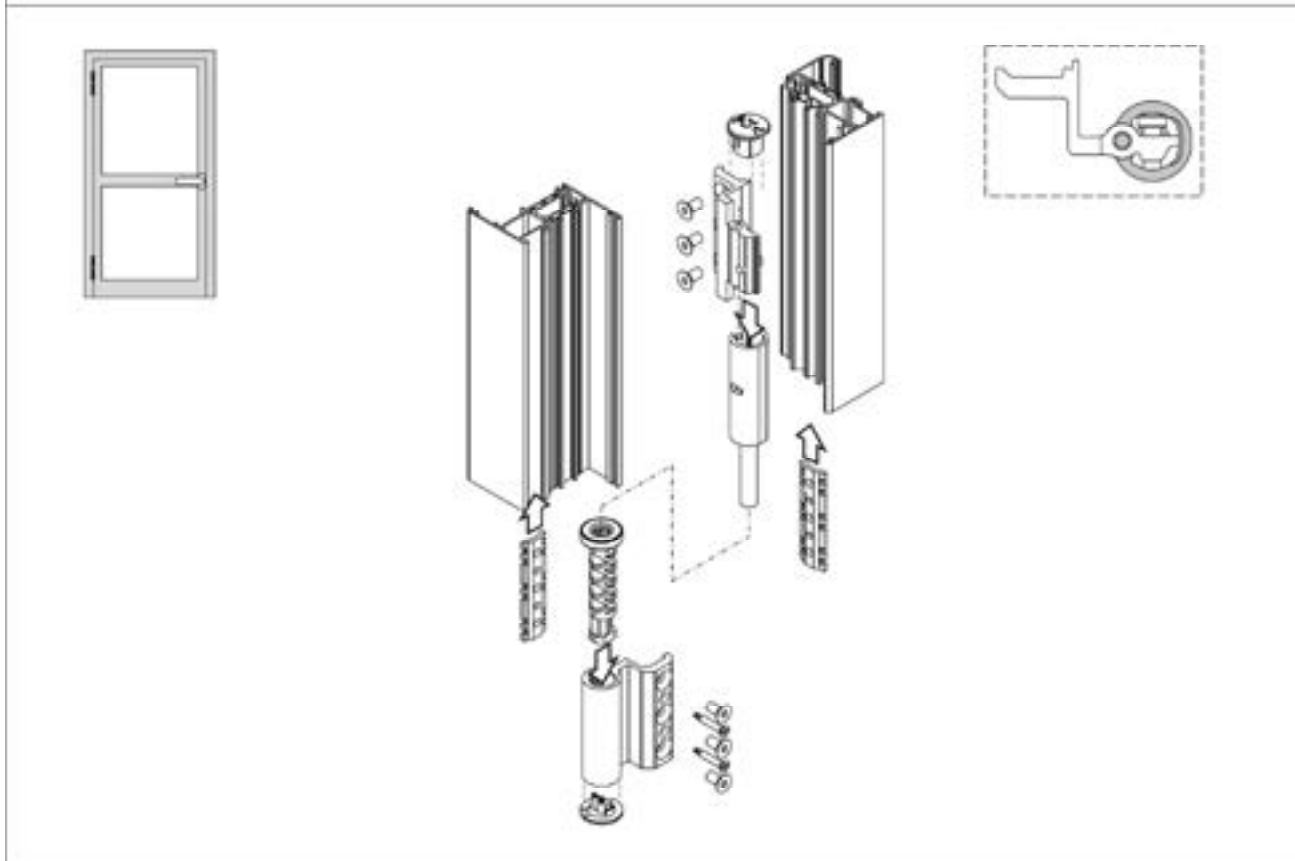
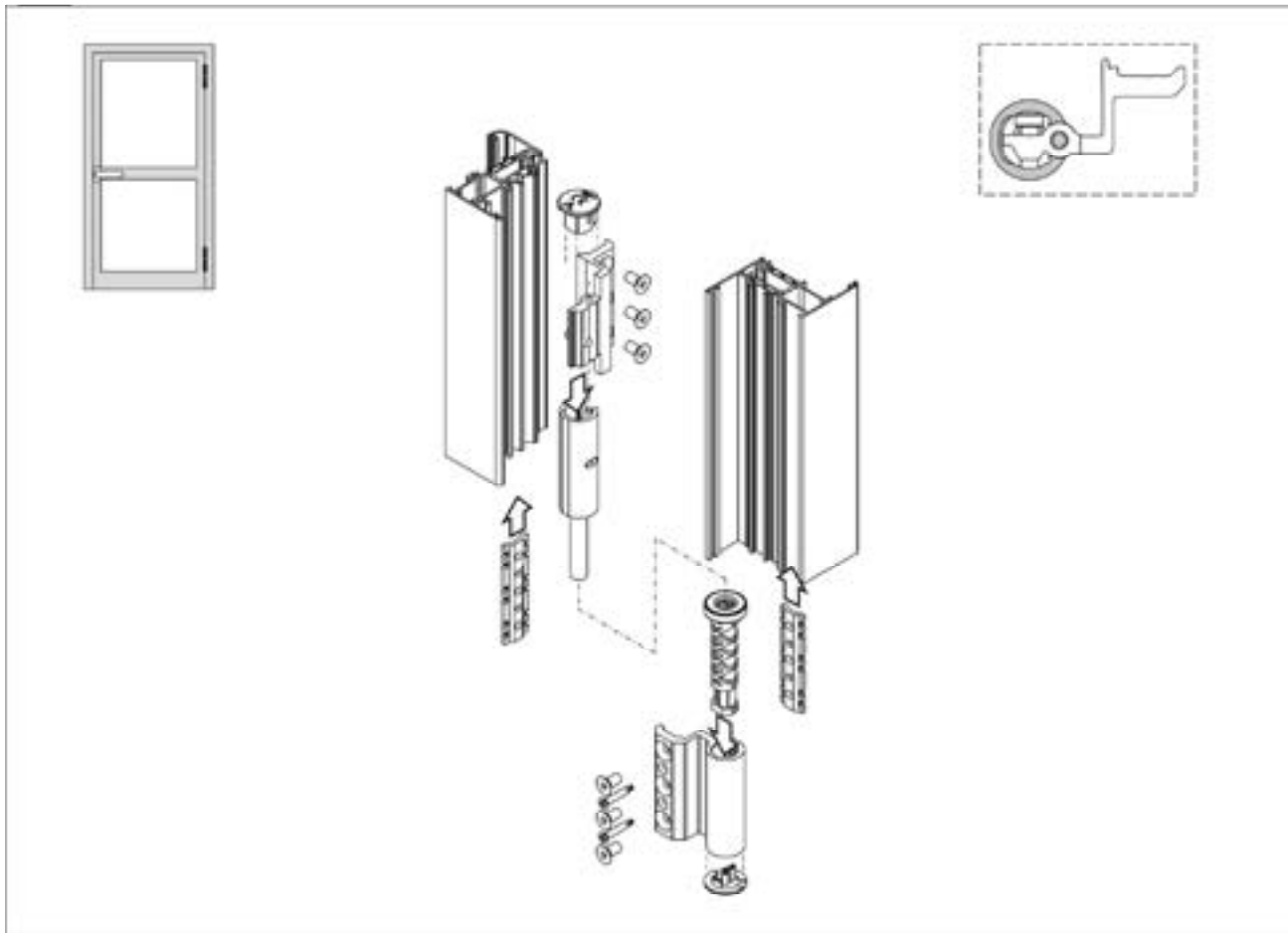

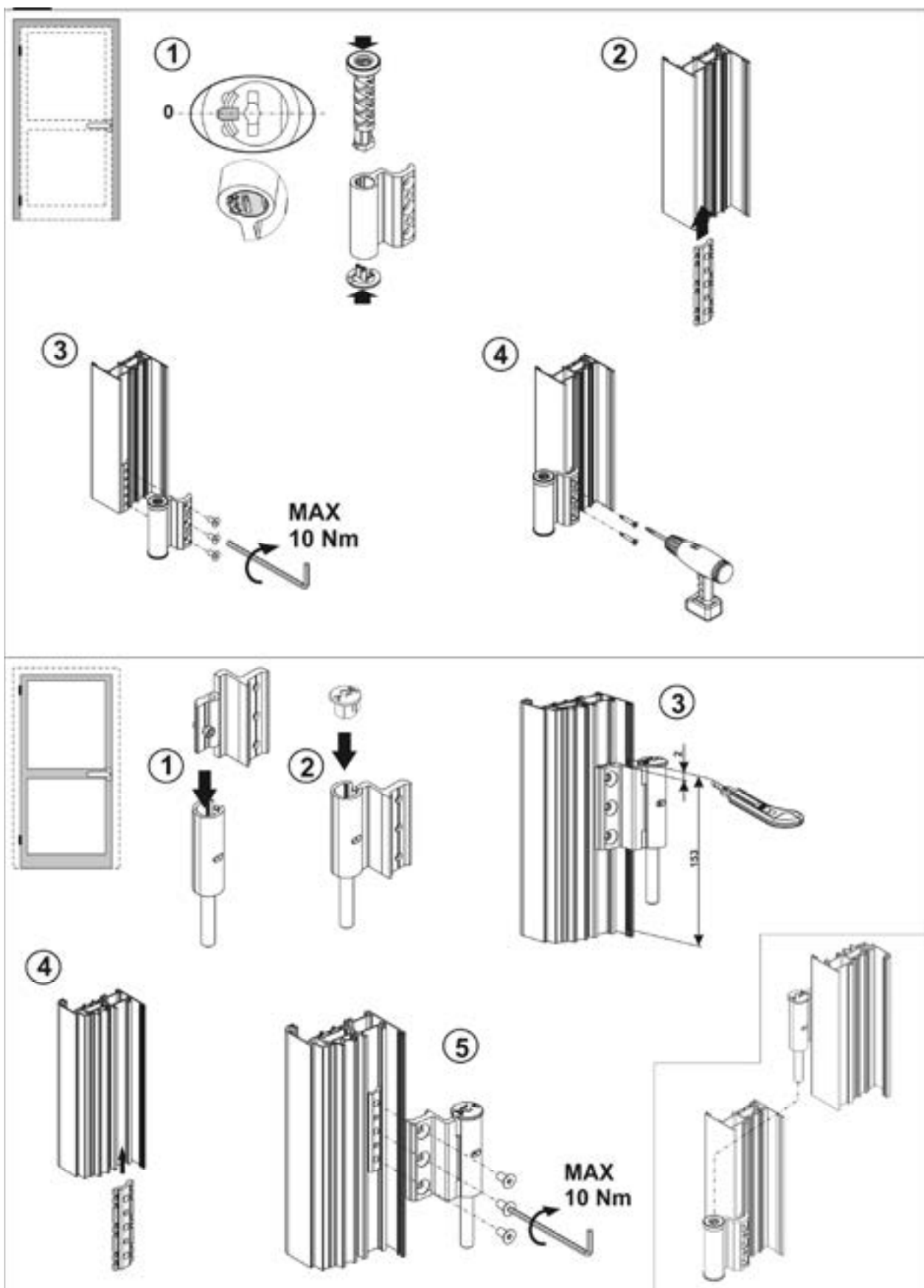

applicazione cover universale ACP 99124 per cerniere strong

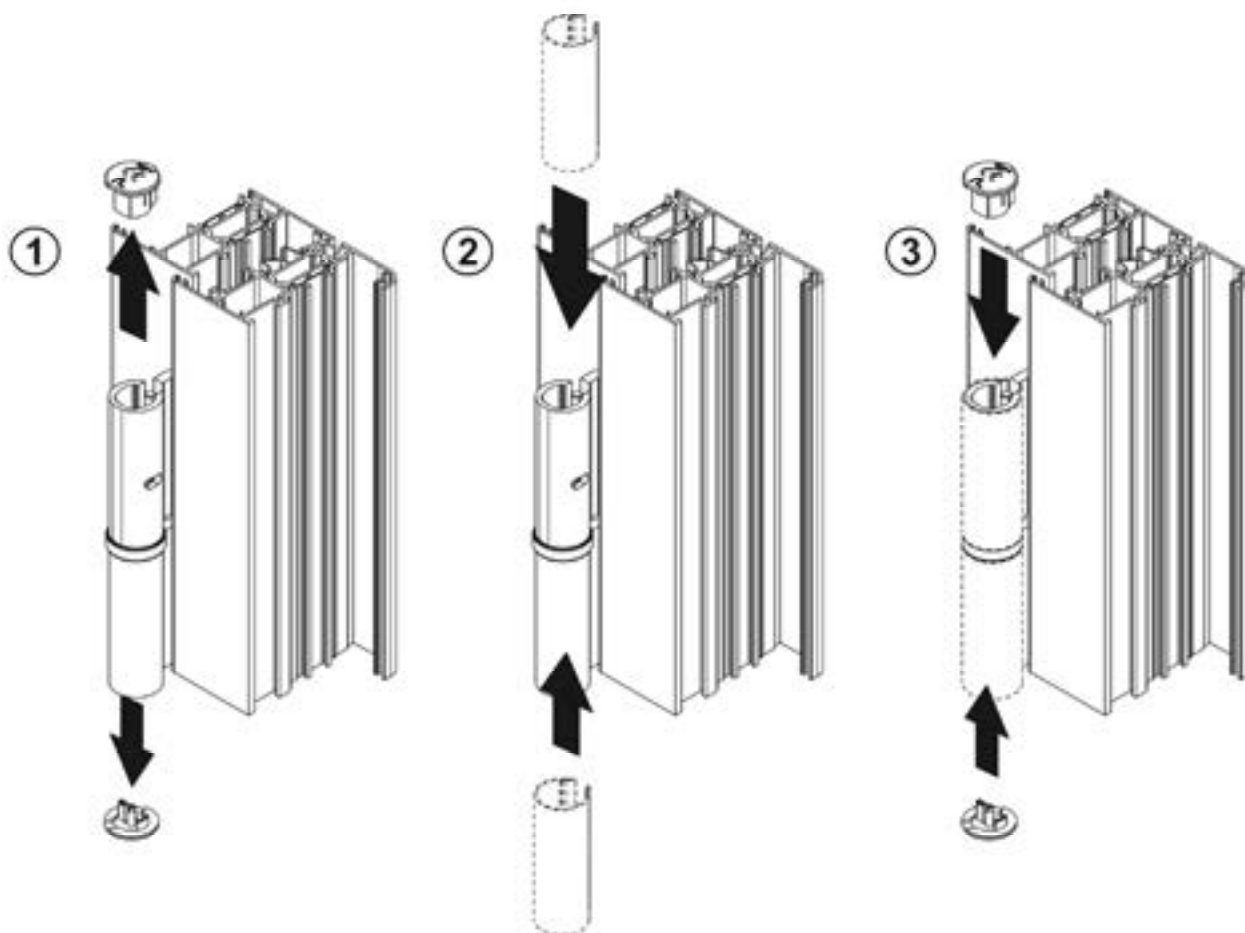
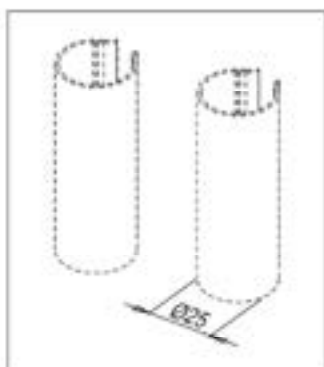

VERSIONE GREZZO - RAW VERSION

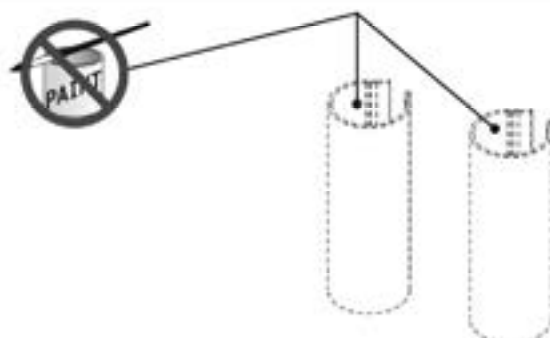

applicazione piastrino di regolazione ACP 99125 per cerniere strong

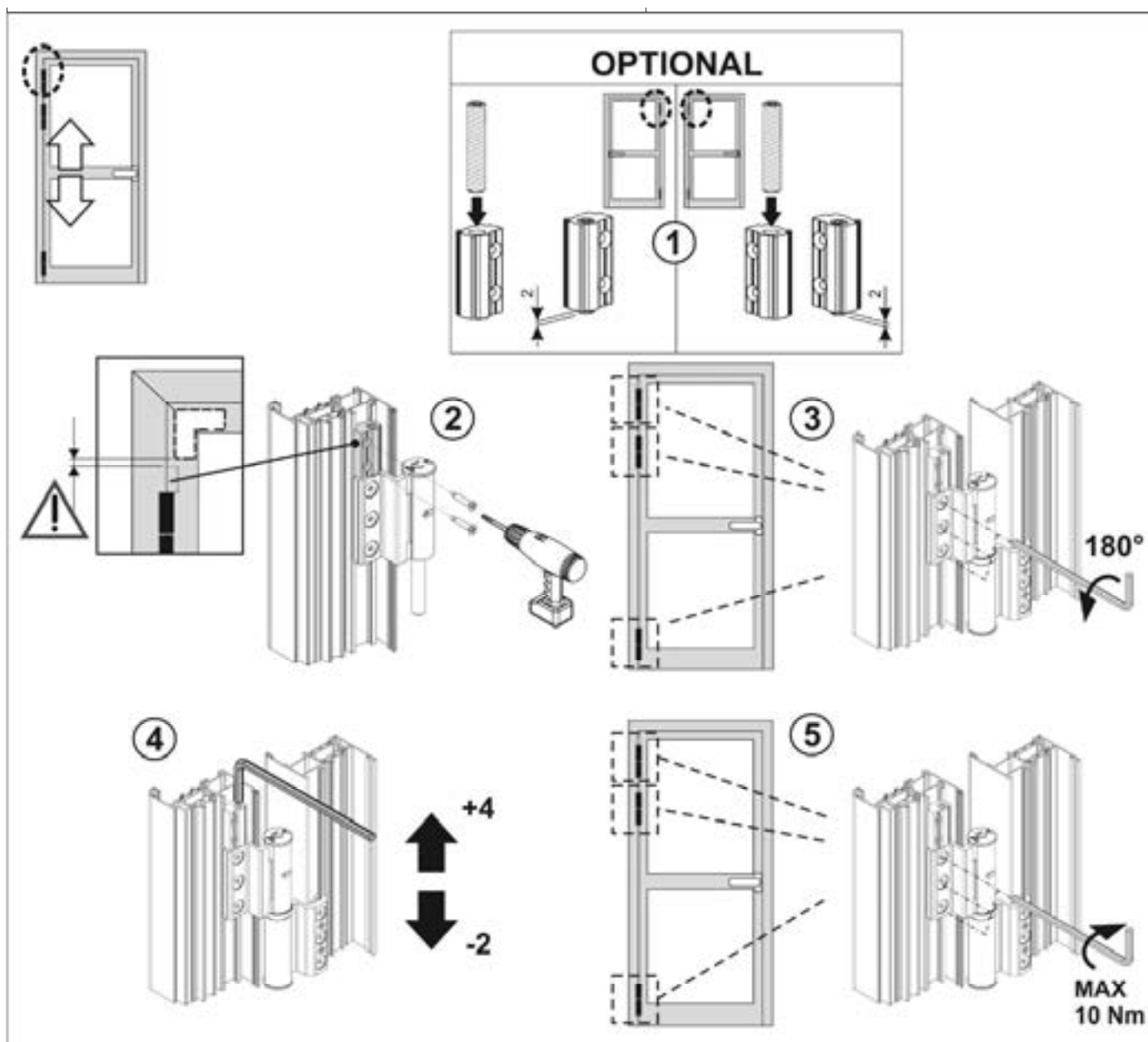

Utilizzo chiave di regolazione ACP 99126 per cerniere strong

La cover indipendente dal corpo centrale permette di mantenere sempre l'allineamento esterno nonostante la registrazione varia da -2 a +2 mm

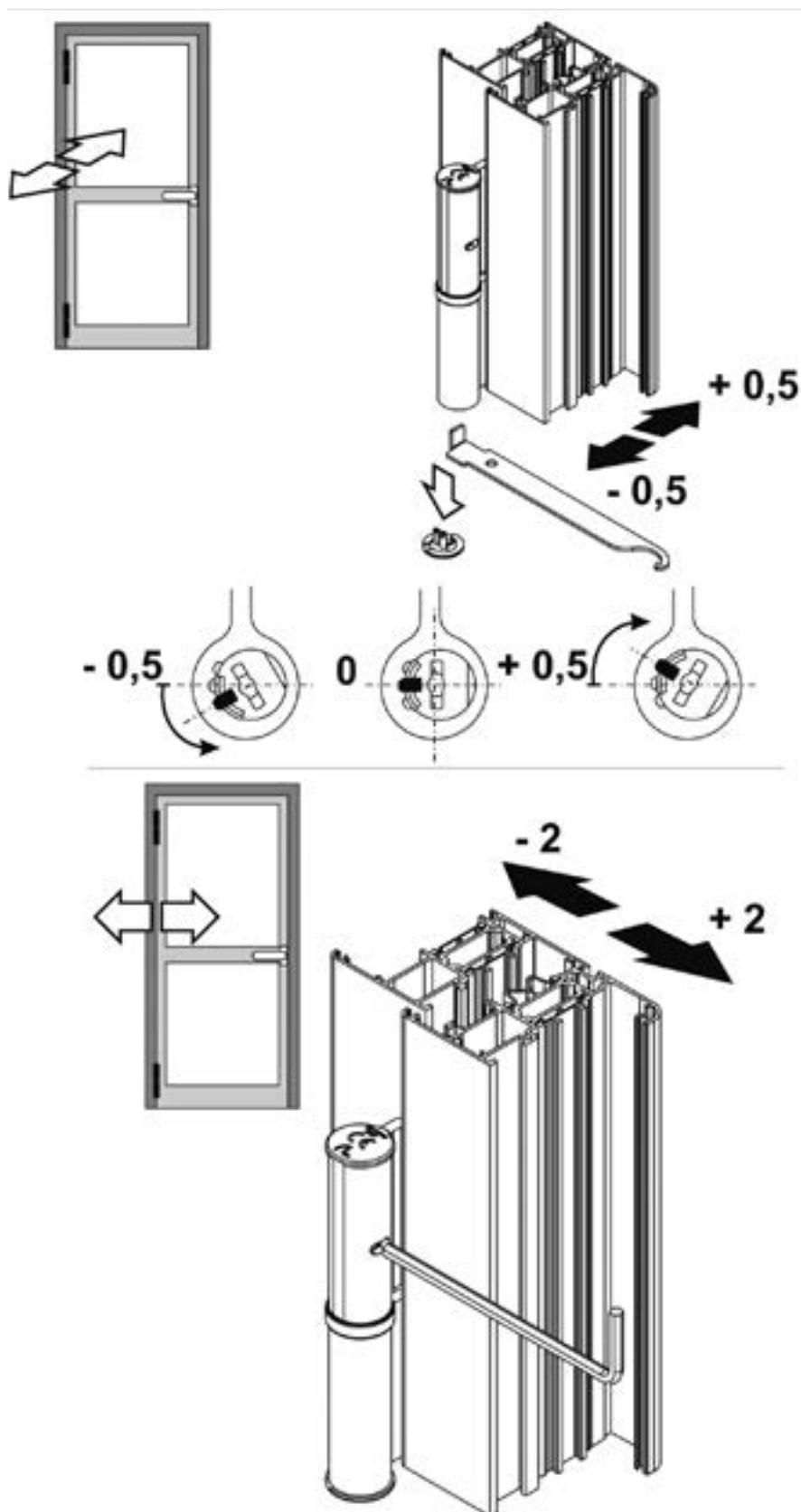

applicazione cerniere frontali ACP 9964/60 interasse 60mm

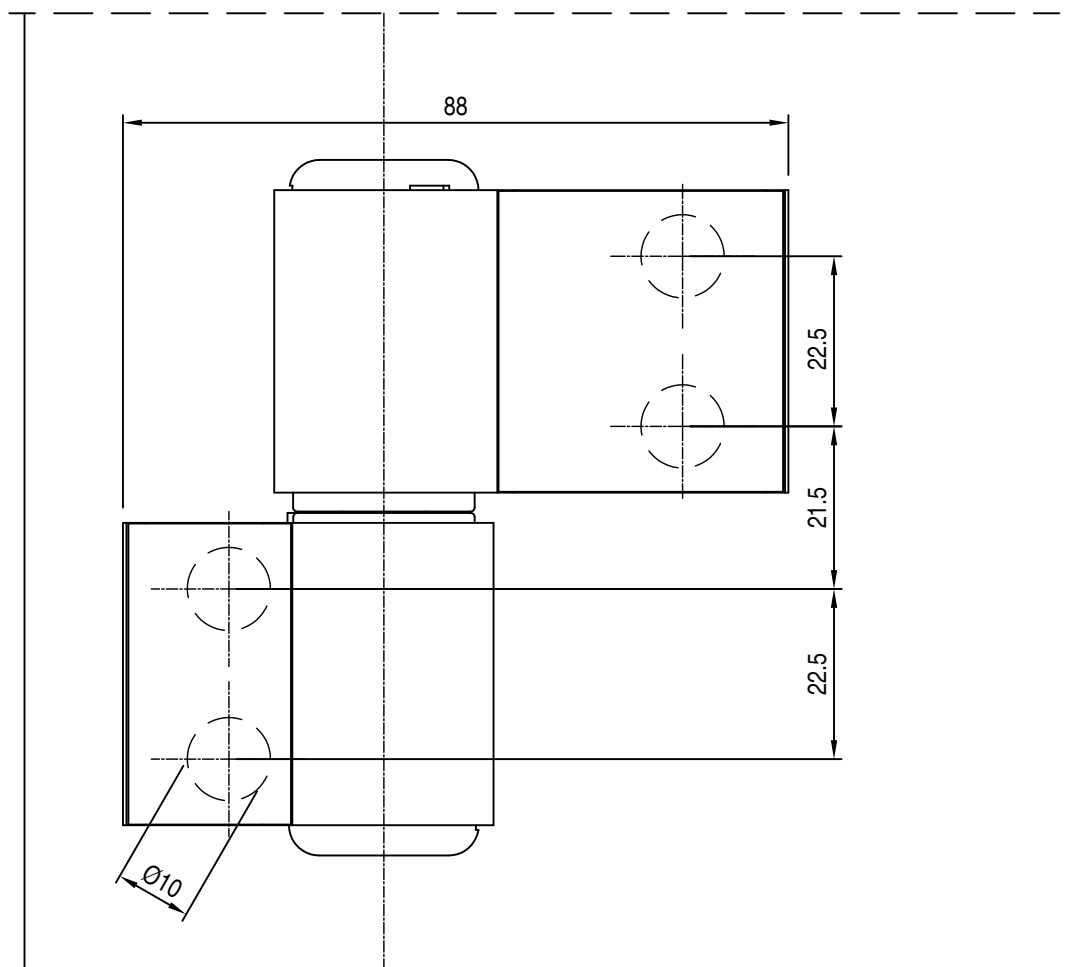

PL 2033

PL 2337

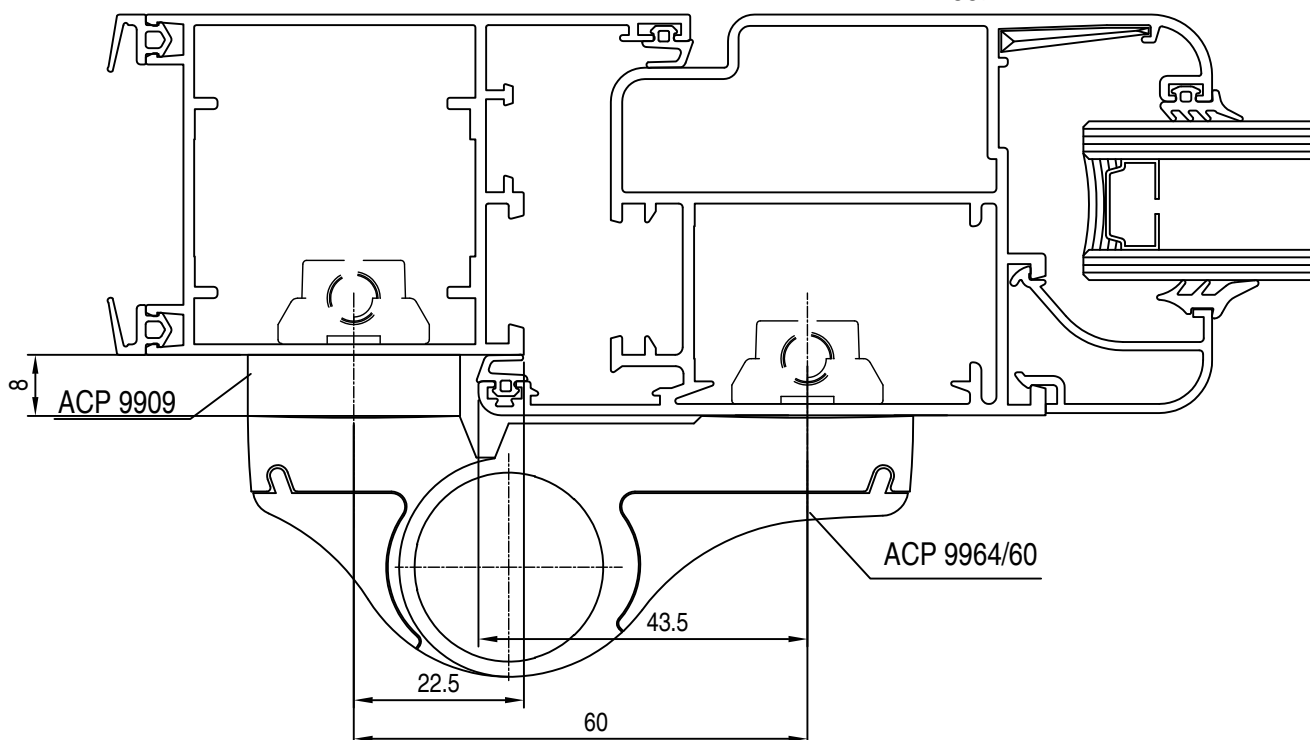

applicazione cerniere frontali ACP 9964/93 interasse 93 mm

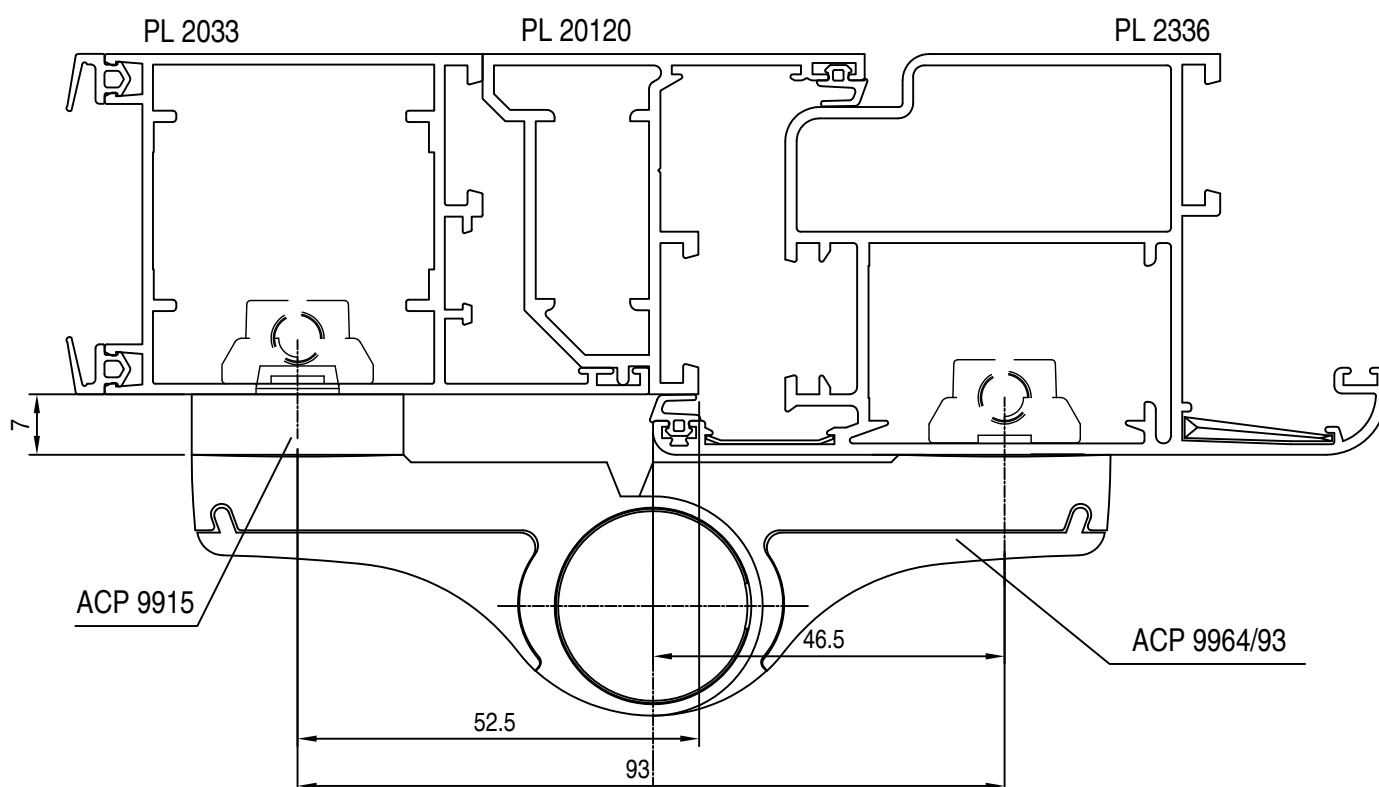
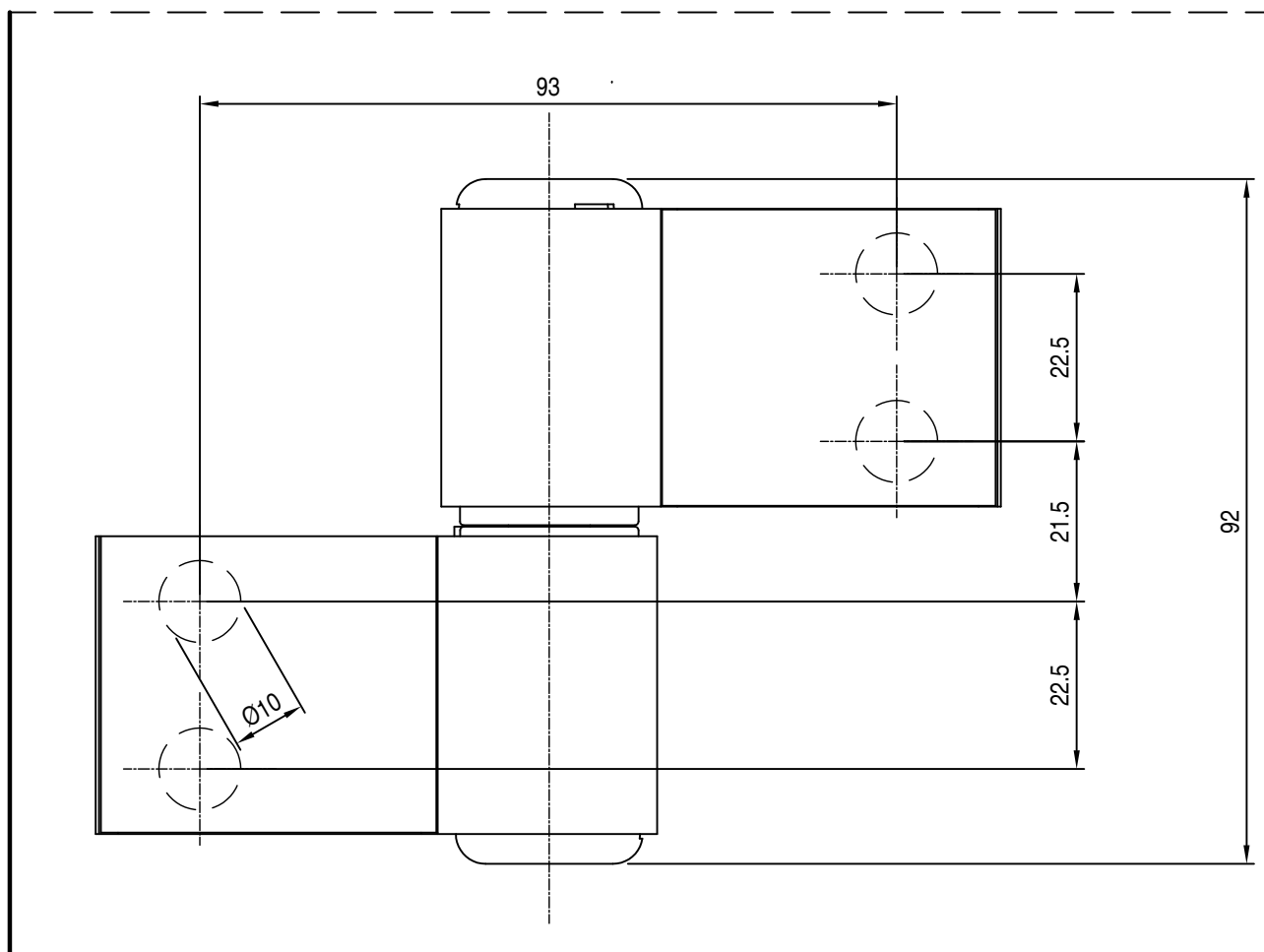

applicazione cerniere frontali ACP 9963/60 interasse 60mm

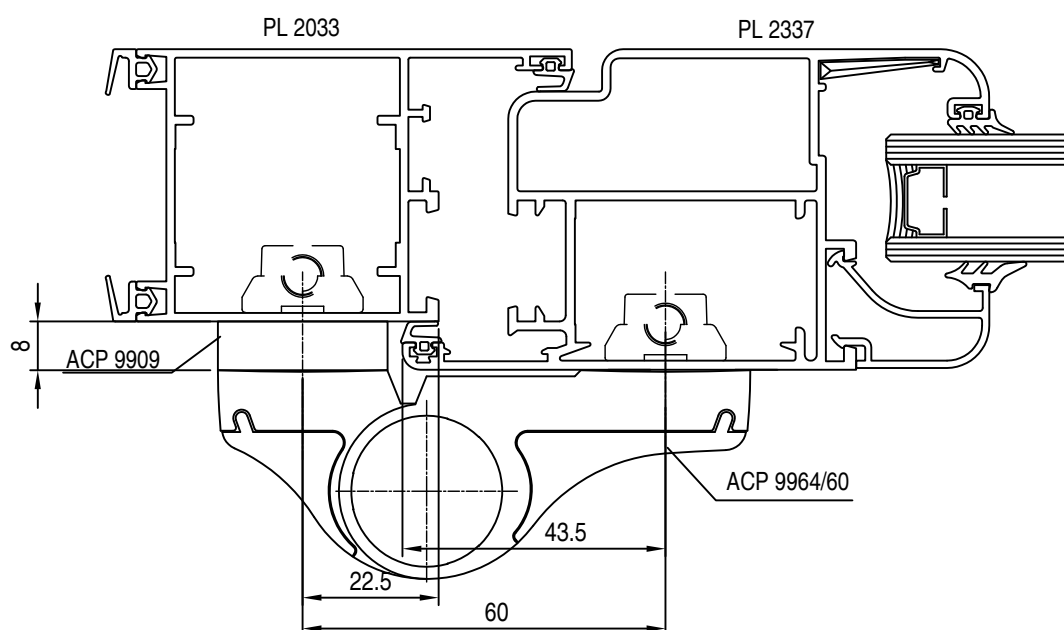
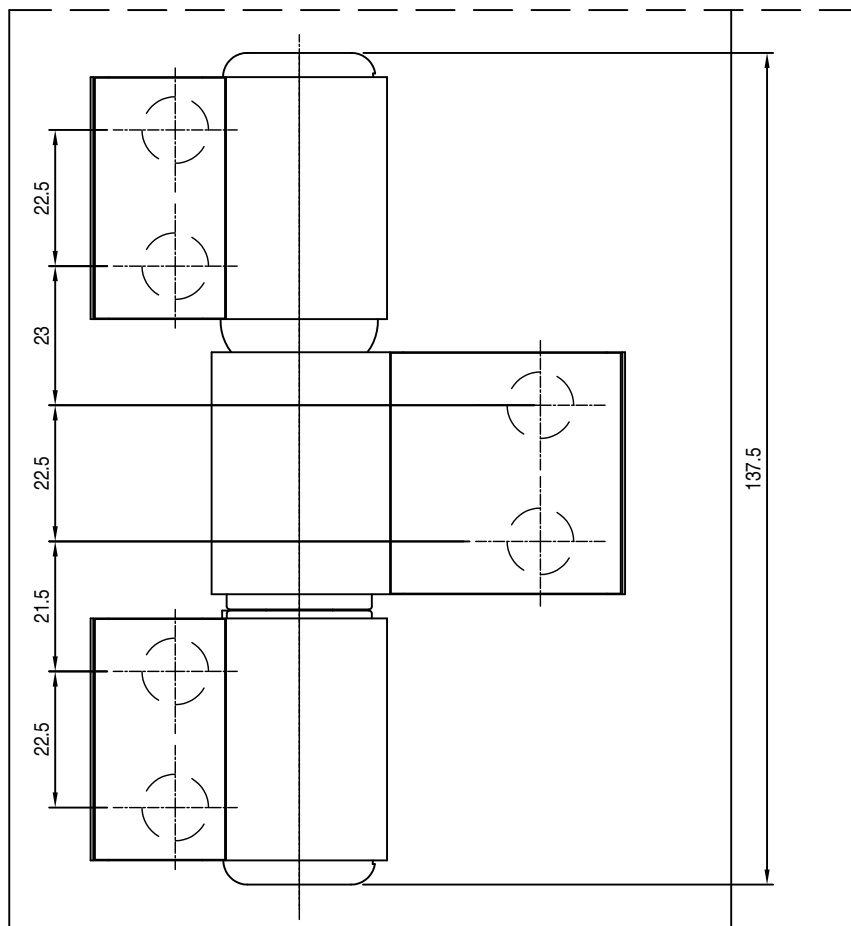

applicazione cerniere frontale ACP 9963/93 interasse 93 mm

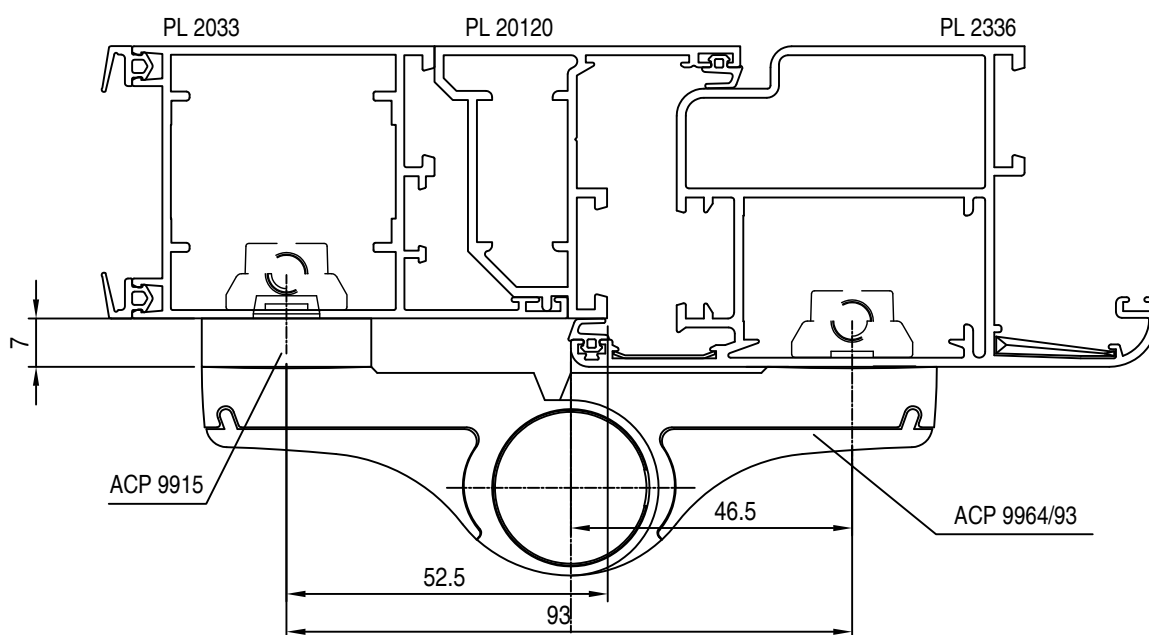
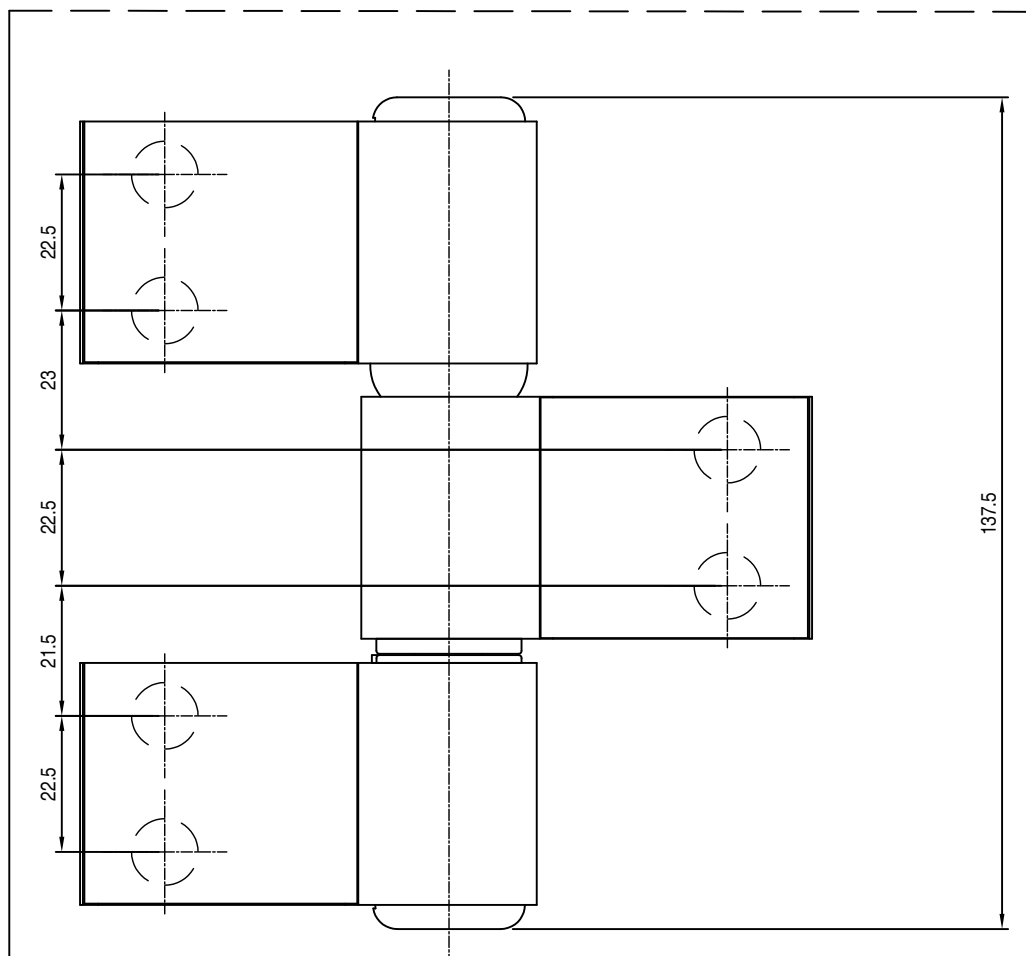

Lavorazione inversione di battuta per applicazione ACP 5090

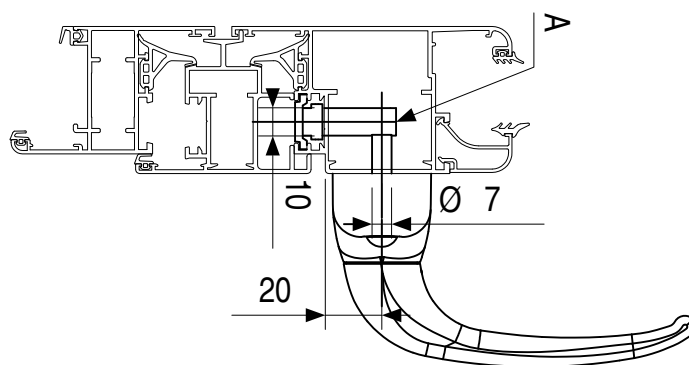

1

lavorazione 1

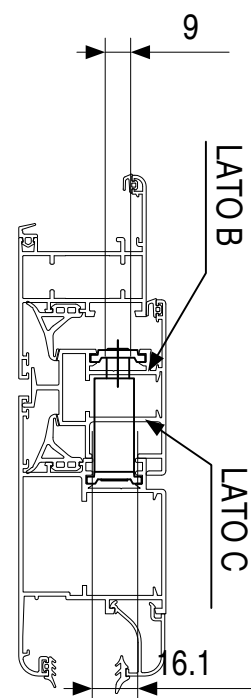
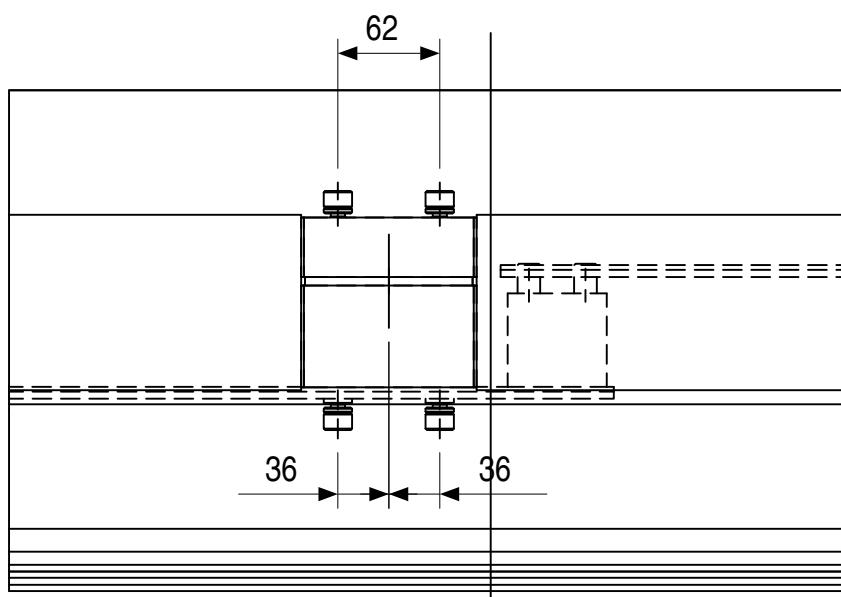
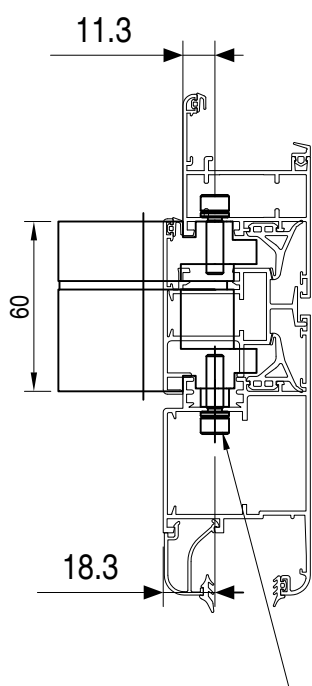

profili di inversione PL 2014

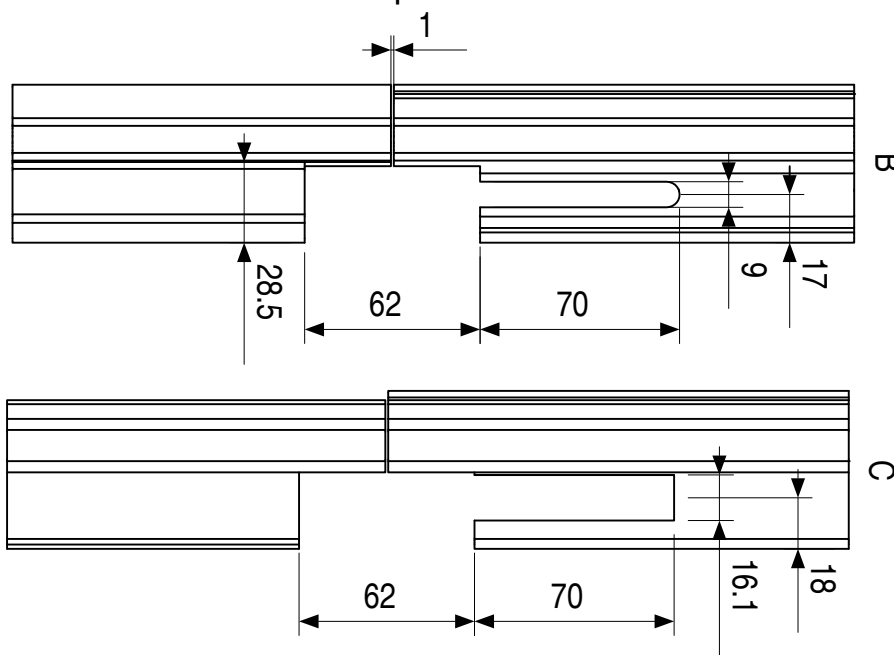

Istruzioni montaggio frizione ACP 5090 più chiusura ACP 5088 per bilico orizzontale

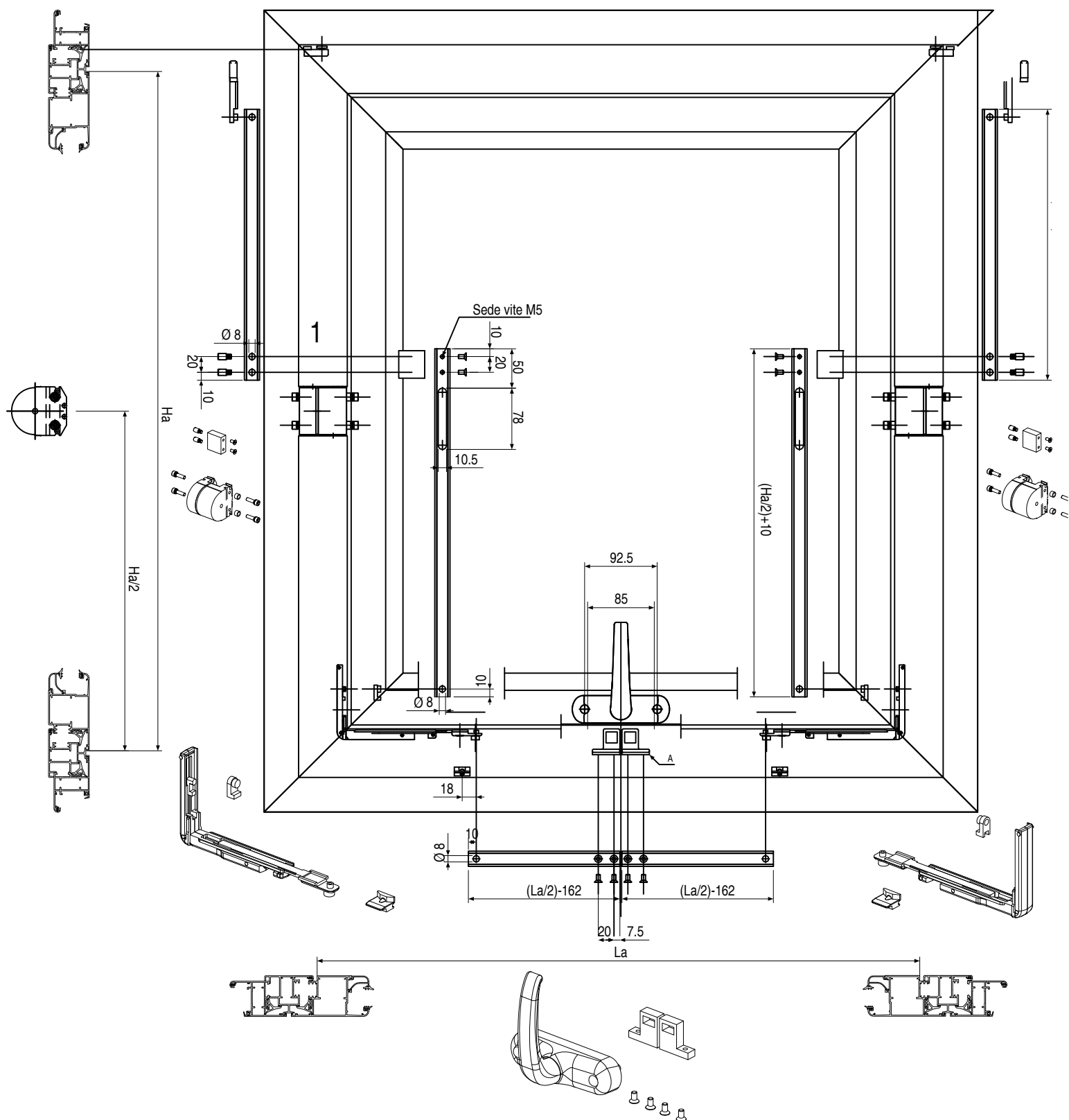

bilico verticale Composizione kit ACP 5086 con 4 punti di chiusura in abbinamento alle frizioni ACP 5090

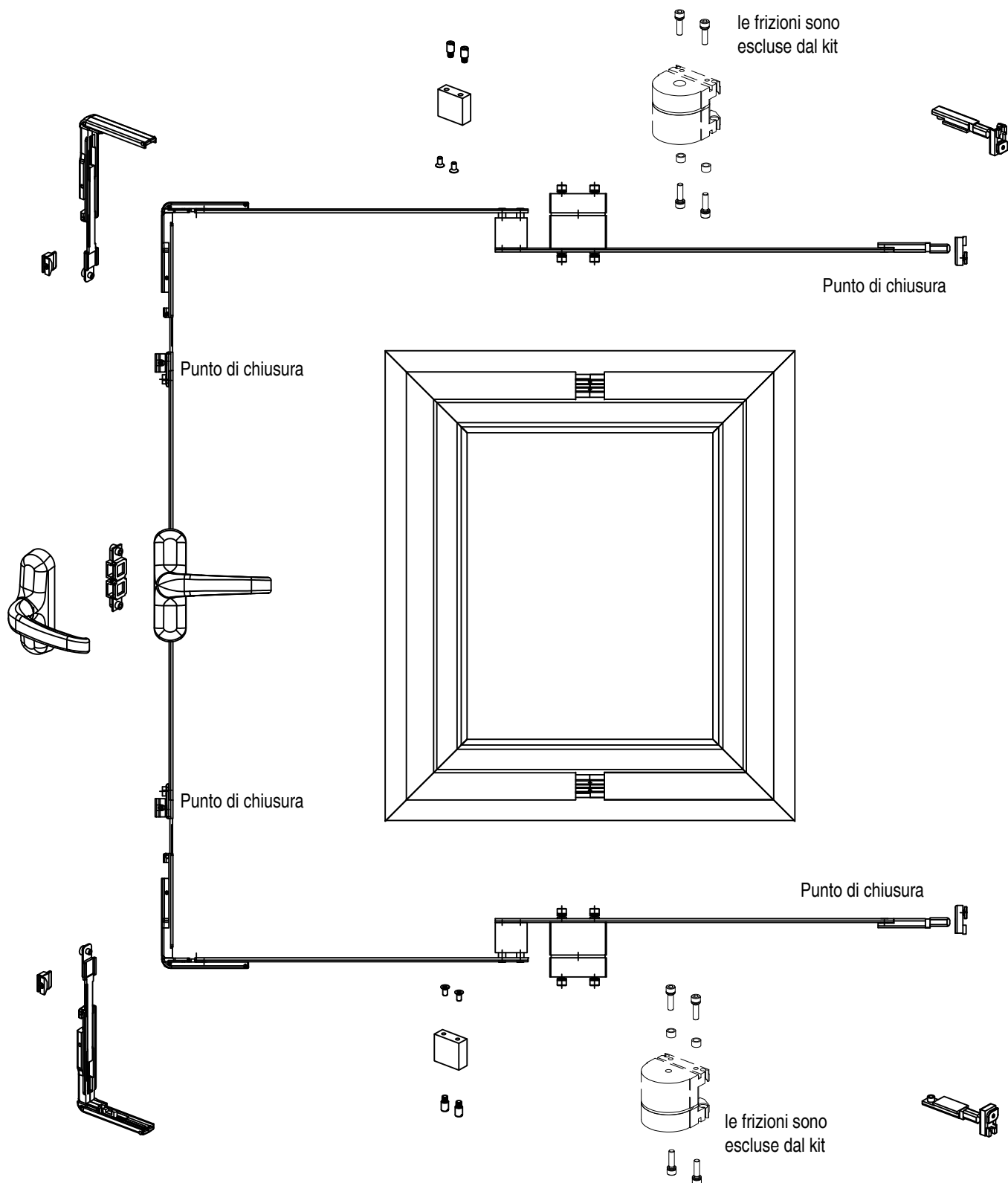





serratura di sicurezza per montante

<table border="1"> <tr> <td colspan="2">Contropiastra Regolabile in Metallo</td> </tr> <tr> <td>A-B-C</td> <td>D E-F</td> </tr> <tr> <td>06463-32</td> <td>06465-42</td> </tr> <tr> <td colspan="2">(17) = inserto rullo art. 06141-71</td> </tr> </table> <table border="1"> <tr> <td colspan="2">CILINDRO SAGOMATO (Nichelato Fin. 12)</td> <td>Frontale</td> </tr> <tr> <td>con borchie</td> <td>senza borchie</td> <td></td> </tr> <tr> <td>OE300-12 L=89 (23,5-39,5)</td> <td>OE300-09 L=83,2 (27,7-35,5)</td> <td>22x3</td> </tr> </table> <p>E= 35 mm</p>	Contropiastra Regolabile in Metallo		A-B-C	D E-F	06463-32	06465-42	(17) = inserto rullo art. 06141-71		CILINDRO SAGOMATO (Nichelato Fin. 12)		Frontale	con borchie	senza borchie		OE300-12 L=89 (23,5-39,5)	OE300-09 L=83,2 (27,7-35,5)	22x3	
Contropiastra Regolabile in Metallo																		
A-B-C	D E-F																	
06463-32	06465-42																	
(17) = inserto rullo art. 06141-71																		
CILINDRO SAGOMATO (Nichelato Fin. 12)		Frontale																
con borchie	senza borchie																	
OE300-12 L=89 (23,5-39,5)	OE300-09 L=83,2 (27,7-35,5)	22x3																
<p>A</p> <p>Art. 18225</p>	<p>B</p> <p>Art. 48225</p>																	
<p>C</p> <p>Art. 48220</p>	<p>D</p> <p>Art. 48250</p>																	
<p>E</p> <p>Art. 06444-21/26-0</p>																		
<p>A</p> <p>Art. 18225</p>	<p>B</p> <p>Art. 48225</p>																	
<p>C</p> <p>Art. 48220</p>	<p>D</p> <p>Art. 48250</p>																	
<p>E</p> <p>Art. 06444-21/26-0</p>	<p>E</p> <p>Art. 06444-21/26-0</p>																	

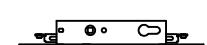
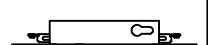
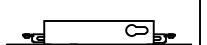

serratura di sicurezza per montante

<table border="1"> <tr><td colspan="2">Contropiastra Regolabile in Metallo</td></tr> <tr><td>A-B-C</td><td>E-F</td></tr> <tr><td>06463-32</td><td>06465-42</td></tr> <tr><td>(17)</td><td>(17)</td></tr> <tr><td colspan="2">(17) = inserto rullo art. 06141-71</td></tr> </table>		Contropiastra Regolabile in Metallo		A-B-C	E-F	06463-32	06465-42	(17)	(17)	(17) = inserto rullo art. 06141-71		<table border="1"> <tr><td colspan="2">CILINDRO SAGOMATO (Nichelato Fin.12)</td></tr> <tr><td colspan="2">Frontale</td></tr> <tr><td colspan="2">con borchie</td></tr> <tr><td colspan="2">senza borchie</td></tr> <tr><td>0E300-12</td><td>0E300-09</td></tr> <tr><td>L=69 (29.5-39.5)</td><td>L=63.2 (27.7-36.5)</td></tr> <tr><td colspan="2">22x3</td></tr> </table>		CILINDRO SAGOMATO (Nichelato Fin.12)		Frontale		con borchie		senza borchie		0E300-12	0E300-09	L=69 (29.5-39.5)	L=63.2 (27.7-36.5)	22x3			
Contropiastra Regolabile in Metallo																													
A-B-C	E-F																												
06463-32	06465-42																												
(17)	(17)																												
(17) = inserto rullo art. 06141-71																													
CILINDRO SAGOMATO (Nichelato Fin.12)																													
Frontale																													
con borchie																													
senza borchie																													
0E300-12	0E300-09																												
L=69 (29.5-39.5)	L=63.2 (27.7-36.5)																												
22x3																													
<p>Art. 18225</p>		<p>Art. 48225</p>		<p>Art. 48220</p>		<p>Art. 48250</p>		<p>Art. 06444-21/26-0</p>																					
<table border="1"> <tr><td colspan="2">Contropiastra Regolabile in Metallo</td></tr> <tr><td>A-B-C</td><td>E-F</td></tr> <tr><td>06463-32</td><td>06465-42</td></tr> <tr><td>(17)</td><td>(17)</td></tr> <tr><td colspan="2">(17) = inserto rullo art. 06141-71</td></tr> </table>		Contropiastra Regolabile in Metallo		A-B-C	E-F	06463-32	06465-42	(17)	(17)	(17) = inserto rullo art. 06141-71		<table border="1"> <tr><td colspan="2">CILINDRO SAGOMATO (Nichelato Fin.12)</td></tr> <tr><td colspan="2">Frontale</td></tr> <tr><td colspan="2">con borchie</td></tr> <tr><td colspan="2">senza borchie</td></tr> <tr><td>0E300-12</td><td>0E300-09</td></tr> <tr><td>L=69 (29.5-39.5)</td><td>L=63.2 (27.7-36.5)</td></tr> <tr><td colspan="2">22x3</td></tr> </table>		CILINDRO SAGOMATO (Nichelato Fin.12)		Frontale		con borchie		senza borchie		0E300-12	0E300-09	L=69 (29.5-39.5)	L=63.2 (27.7-36.5)	22x3			
Contropiastra Regolabile in Metallo																													
A-B-C	E-F																												
06463-32	06465-42																												
(17)	(17)																												
(17) = inserto rullo art. 06141-71																													
CILINDRO SAGOMATO (Nichelato Fin.12)																													
Frontale																													
con borchie																													
senza borchie																													
0E300-12	0E300-09																												
L=69 (29.5-39.5)	L=63.2 (27.7-36.5)																												
22x3																													
<p>Art. 18225</p>		<p>Art. 48225</p>		<p>Art. 48220</p>		<p>Art. 48250</p>		<p>Art. 06444-21/26-0</p>																					

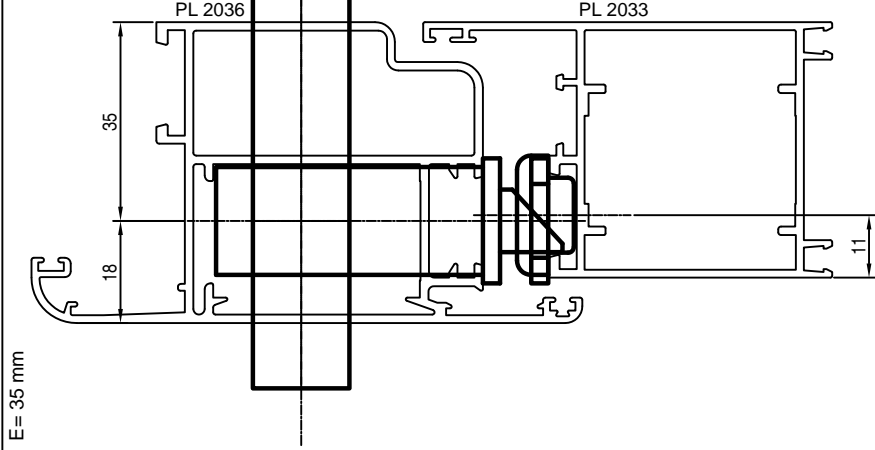
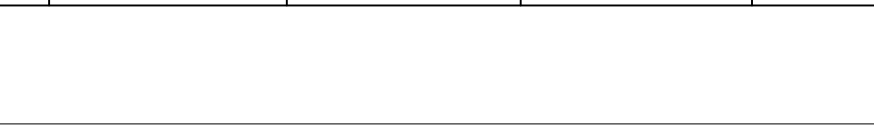
serratura di sicurezza per montante

<p>Art. 16205</p> 	<p>Art. 16215 Art. 16225 Art. 16217 Art. 16227</p> 	<p>Art. 46215 Art. 46225 Art. 46217 Art. 46227</p> 	<p>Art. 46230 Art. 46250 Art. 46252</p> 	<p>Art. 46210 Art. 46220 Art. 46212 Art. 46222</p> 	 <p>Art. 06443-00/05-0</p>									
<p>Contropiastra Regolabile in Metallo</p> <table border="1" data-bbox="135 1332 295 1668"> <tr> <th>A-B-C</th> <th>D</th> <th>E-F</th> </tr> <tr> <td>06463-22</td> <td>06463-22 (17)</td> <td>06465-22</td> </tr> <tr> <td colspan="3">(17) = inserto rullo art. 06141-71</td> </tr> </table>						A-B-C	D	E-F	06463-22	06463-22 (17)	06465-22	(17) = inserto rullo art. 06141-71		
A-B-C	D	E-F												
06463-22	06463-22 (17)	06465-22												
(17) = inserto rullo art. 06141-71														
<p>CILINDRO SAGOMATO (Nichelato Fin.12) Frontale</p> <table border="1" data-bbox="327 1332 486 1668"> <tr> <th>con borchie</th> <th>senza borchie</th> </tr> <tr> <td>0E300-12 L=69 (29,5-39,5)</td> <td>0E300-09 L=63,2 (27,7-35,5)</td> </tr> <tr> <td colspan="2">22x3</td> </tr> </table>						con borchie	senza borchie	0E300-12 L=69 (29,5-39,5)	0E300-09 L=63,2 (27,7-35,5)	22x3				
con borchie	senza borchie													
0E300-12 L=69 (29,5-39,5)	0E300-09 L=63,2 (27,7-35,5)													
22x3														
 <p>E = 35 mm</p>														
<p>Contropiastra Regolabile in Metallo</p> <table border="1" data-bbox="135 1870 295 2206"> <tr> <th>A-B-C</th> <th>D</th> <th>E-F</th> </tr> <tr> <td>06463-22</td> <td>06463-22 (17)</td> <td>06465-22</td> </tr> <tr> <td colspan="3">(17) = inserto rullo art. 06141-71</td> </tr> </table>						A-B-C	D	E-F	06463-22	06463-22 (17)	06465-22	(17) = inserto rullo art. 06141-71		
A-B-C	D	E-F												
06463-22	06463-22 (17)	06465-22												
(17) = inserto rullo art. 06141-71														
<p>CILINDRO SAGOMATO (Nichelato Fin.12) Frontale</p> <table border="1" data-bbox="327 1870 486 2206"> <tr> <th>con borchie</th> <th>senza borchie</th> </tr> <tr> <td>0E300-12 L=69 (29,5-39,5)</td> <td>0E300-09 L=63,2 (27,7-35,5)</td> </tr> <tr> <td colspan="2">22x3</td> </tr> </table>						con borchie	senza borchie	0E300-12 L=69 (29,5-39,5)	0E300-09 L=63,2 (27,7-35,5)	22x3				
con borchie	senza borchie													
0E300-12 L=69 (29,5-39,5)	0E300-09 L=63,2 (27,7-35,5)													
22x3														
 <p>E = 35 mm</p>														

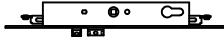
serratura di sicurezza per montante

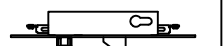
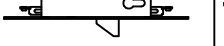
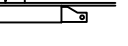
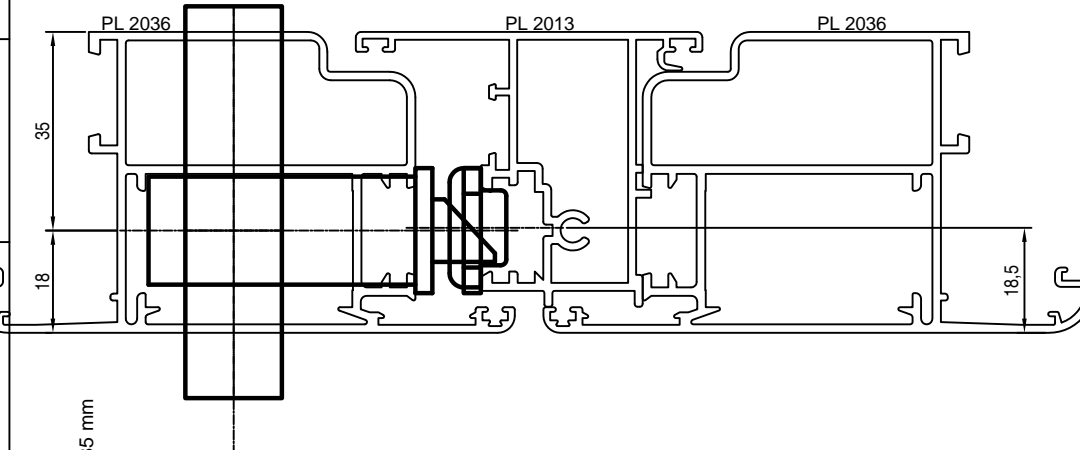
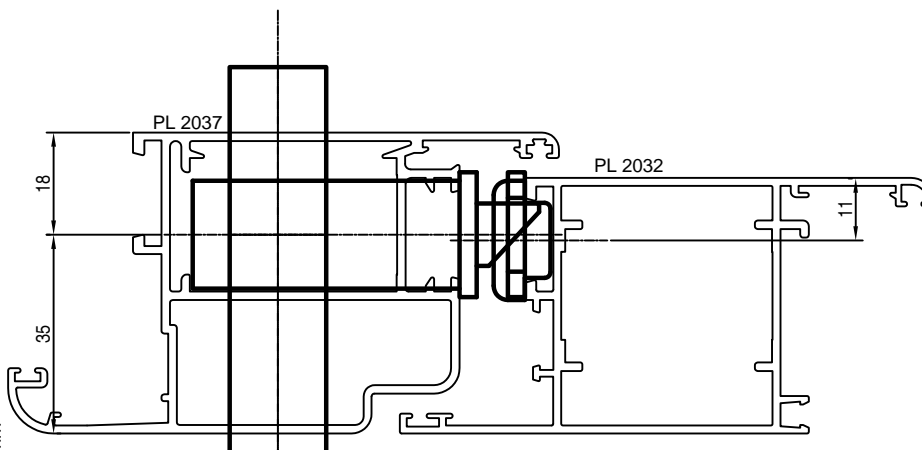
<p>A</p> <p>Art. 16205</p> 	<p>B</p> <p>Art. 16215 Art. 16225 Art. 16217 Art. 16227</p> 	<p>C</p> <p>Art. 46215 Art. 46225 Art. 46217 Art. 46227</p> 	<p>D</p> <p>Art. 46230 Art. 46250 Art. 46252</p> 	<p>E</p> <p>Art. 46210 Art. 46220 Art. 46212 Art. 46222</p> 	<p>F</p>  <p>Art. 06444-21/26-0</p>																												
<table border="1"> <tr> <td colspan="2">Contropiastra Regolabile in Metallo</td> <td colspan="2">Frontale</td> </tr> <tr> <td>A-B-C</td> <td>D E-F</td> <td colspan="2">22x3</td> </tr> <tr> <td>06463-22</td> <td>06463-22 (17)</td> <td colspan="2">06465-22</td> </tr> <tr> <td colspan="4">(17) = inserto rullo art. 06141-71</td> </tr> <tr> <td colspan="4">CILINDRO SAGOMATO (Nichelato Fin.12)</td> </tr> <tr> <td colspan="2">con borchie</td> <td colspan="2">senza borchie</td> </tr> <tr> <td>0E300-12 L=69 (29,5-39,5)</td> <td>0E300-09 L=63,2 (27,7-35,5)</td> <td colspan="2"></td> </tr> </table>  <p>E = 35 mm</p>						Contropiastra Regolabile in Metallo		Frontale		A-B-C	D E-F	22x3		06463-22	06463-22 (17)	06465-22		(17) = inserto rullo art. 06141-71				CILINDRO SAGOMATO (Nichelato Fin.12)				con borchie		senza borchie		0E300-12 L=69 (29,5-39,5)	0E300-09 L=63,2 (27,7-35,5)		
Contropiastra Regolabile in Metallo		Frontale																															
A-B-C	D E-F	22x3																															
06463-22	06463-22 (17)	06465-22																															
(17) = inserto rullo art. 06141-71																																	
CILINDRO SAGOMATO (Nichelato Fin.12)																																	
con borchie		senza borchie																															
0E300-12 L=69 (29,5-39,5)	0E300-09 L=63,2 (27,7-35,5)																																
<table border="1"> <tr> <td colspan="2">Contropiastra Regolabile in Metallo</td> <td colspan="2">Frontale</td> </tr> <tr> <td>A-B-C</td> <td>D E-F</td> <td colspan="2">22x3</td> </tr> <tr> <td>06463-22</td> <td>06463-22 (17)</td> <td colspan="2">06465-22</td> </tr> <tr> <td colspan="4">(17) = inserto rullo art. 06141-71</td> </tr> <tr> <td colspan="4">CILINDRO SAGOMATO (Nichelato Fin.12)</td> </tr> <tr> <td colspan="2">con borchie</td> <td colspan="2">senza borchie</td> </tr> <tr> <td>0E300-12 L=69 (29,5-39,5)</td> <td>0E300-41 L=63,2 (27,7-35,5)</td> <td colspan="2"></td> </tr> </table>  <p>E = 35 mm</p>						Contropiastra Regolabile in Metallo		Frontale		A-B-C	D E-F	22x3		06463-22	06463-22 (17)	06465-22		(17) = inserto rullo art. 06141-71				CILINDRO SAGOMATO (Nichelato Fin.12)				con borchie		senza borchie		0E300-12 L=69 (29,5-39,5)	0E300-41 L=63,2 (27,7-35,5)		
Contropiastra Regolabile in Metallo		Frontale																															
A-B-C	D E-F	22x3																															
06463-22	06463-22 (17)	06465-22																															
(17) = inserto rullo art. 06141-71																																	
CILINDRO SAGOMATO (Nichelato Fin.12)																																	
con borchie		senza borchie																															
0E300-12 L=69 (29,5-39,5)	0E300-41 L=63,2 (27,7-35,5)																																

serratura di sicurezza per montante multipunto

<table border="1" style="width: 100%; border-collapse: collapse;"> <tr> <th colspan="3">Contropiastra Regolabile in Metallo</th> </tr> <tr> <td style="width: 33%;">A</td> <td style="width: 33%;">B</td> <td style="width: 33%;">C</td> </tr> <tr> <td>06463-32</td> <td>06463-32 (16)</td> <td>06465-42</td> </tr> <tr> <td colspan="3" style="text-align: center;">(17) = inserto rullo art. 06141-71</td> </tr> <tr> <td colspan="3">Deviatori 06465-42 (pz.2)</td> </tr> </table>	Contropiastra Regolabile in Metallo			A	B	C	06463-32	06463-32 (16)	06465-42	(17) = inserto rullo art. 06141-71			Deviatori 06465-42 (pz.2)			<table border="1" style="width: 100%; border-collapse: collapse;"> <tr> <th colspan="2">CILINDRO SAGOMATO (Nichelato Fin.12)</th> <th>Frontale</th> </tr> <tr> <td colspan="2">con borchie</td> <td>senza borchie</td> </tr> <tr> <td>0E300-12 L=69 (29.5-39.5)</td> <td>0E300-41 L=63.2 (27.7-35.5)</td> <td>24x3</td> </tr> </table>	CILINDRO SAGOMATO (Nichelato Fin.12)		Frontale	con borchie		senza borchie	0E300-12 L=69 (29.5-39.5)	0E300-41 L=63.2 (27.7-35.5)	24x3	<p style="text-align: center;">E = 35 mm</p>
Contropiastra Regolabile in Metallo																										
A	B	C																								
06463-32	06463-32 (16)	06465-42																								
(17) = inserto rullo art. 06141-71																										
Deviatori 06465-42 (pz.2)																										
CILINDRO SAGOMATO (Nichelato Fin.12)		Frontale																								
con borchie		senza borchie																								
0E300-12 L=69 (29.5-39.5)	0E300-41 L=63.2 (27.7-35.5)	24x3																								
<p>A</p>	<p>B</p>	<p>C</p>																								
Art. 18526 Art. 48526	Art. 48551	Art. 48521																								

<table border="1" style="width: 100%; border-collapse: collapse;"> <tr> <th colspan="3">Contropiastra Regolabile in Metallo</th> </tr> <tr> <td style="width: 33%;">A</td> <td style="width: 33%;">B</td> <td style="width: 33%;">C</td> </tr> <tr> <td>06463-32</td> <td>06463-32 (16)</td> <td>06465-42</td> </tr> <tr> <td colspan="3" style="text-align: center;">(17) = inserto rullo art. 06141-71</td> </tr> <tr> <td colspan="3">Deviatori 06465-42 (pz.2)</td> </tr> </table>	Contropiastra Regolabile in Metallo			A	B	C	06463-32	06463-32 (16)	06465-42	(17) = inserto rullo art. 06141-71			Deviatori 06465-42 (pz.2)			<table border="1" style="width: 100%; border-collapse: collapse;"> <tr> <th colspan="2">CILINDRO SAGOMATO (Nichelato Fin.12)</th> <th>Frontale</th> </tr> <tr> <td colspan="2">con borchie</td> <td>senza borchie</td> </tr> <tr> <td>0E300-12 L=69 (29.5-39.5)</td> <td>0E300-09 L=63.2 (27.7-35.5)</td> <td>24x3</td> </tr> </table>	CILINDRO SAGOMATO (Nichelato Fin.12)		Frontale	con borchie		senza borchie	0E300-12 L=69 (29.5-39.5)	0E300-09 L=63.2 (27.7-35.5)	24x3	<p style="text-align: center;">E = 35 mm</p>
Contropiastra Regolabile in Metallo																										
A	B	C																								
06463-32	06463-32 (16)	06465-42																								
(17) = inserto rullo art. 06141-71																										
Deviatori 06465-42 (pz.2)																										
CILINDRO SAGOMATO (Nichelato Fin.12)		Frontale																								
con borchie		senza borchie																								
0E300-12 L=69 (29.5-39.5)	0E300-09 L=63.2 (27.7-35.5)	24x3																								
<p>A</p>	<p>B</p>	<p>C</p>																								
Art. 18526 Art. 48526	Art. 48551	Art. 48521																								

serratura di sicurezza per montante multipunto

<table border="1" style="width: 100%; border-collapse: collapse;"> <tr> <th colspan="3">Contropiastra Regolabile in Metallo</th> </tr> <tr> <td style="width: 33%;">A</td> <td style="width: 33%;">B</td> <td style="width: 33%;">C</td> </tr> <tr> <td>06463-32</td> <td>06463-32 (16)</td> <td>06465-42 (pz.2)</td> </tr> <tr> <td colspan="3">(17) = inserto rullo art. 06141-71</td> </tr> </table>	Contropiastra Regolabile in Metallo			A	B	C	06463-32	06463-32 (16)	06465-42 (pz.2)	(17) = inserto rullo art. 06141-71			<table border="1" style="width: 100%; border-collapse: collapse;"> <tr> <th colspan="2">CILINDRO SAGOMATO (Nichelato Fin.12)</th> <th>Frontale</th> </tr> <tr> <td colspan="2">con borchie</td> <td>senza borchie</td> </tr> <tr> <td style="width: 33%;">0E300-12 L=69 (28.5-39.5)</td> <td style="width: 33%;">0E300-41 L=63.2 (27.7-35.5)</td> <td>24x3</td> </tr> </table>	CILINDRO SAGOMATO (Nichelato Fin.12)		Frontale	con borchie		senza borchie	0E300-12 L=69 (28.5-39.5)	0E300-41 L=63.2 (27.7-35.5)	24x3	
Contropiastra Regolabile in Metallo																							
A	B	C																					
06463-32	06463-32 (16)	06465-42 (pz.2)																					
(17) = inserto rullo art. 06141-71																							
CILINDRO SAGOMATO (Nichelato Fin.12)		Frontale																					
con borchie		senza borchie																					
0E300-12 L=69 (28.5-39.5)	0E300-41 L=63.2 (27.7-35.5)	24x3																					
<table border="1" style="width: 100%; border-collapse: collapse;"> <tr> <th colspan="3">Contropiastra Regolabile in Metallo</th> </tr> <tr> <td style="width: 33%;">A</td> <td style="width: 33%;">B</td> <td style="width: 33%;">C</td> </tr> <tr> <td>06463-32</td> <td>06463-32 (16)</td> <td>06465-42 (pz.2)</td> </tr> <tr> <td colspan="3">(17) = inserto rullo art. 06141-71</td> </tr> </table>	Contropiastra Regolabile in Metallo			A	B	C	06463-32	06463-32 (16)	06465-42 (pz.2)	(17) = inserto rullo art. 06141-71			<table border="1" style="width: 100%; border-collapse: collapse;"> <tr> <th colspan="2">CILINDRO SAGOMATO (Nichelato Fin.12)</th> <th>Frontale</th> </tr> <tr> <td colspan="2">con borchie</td> <td>senza borchie</td> </tr> <tr> <td style="width: 33%;">0E300-12 L=69 (28.5-39.5)</td> <td style="width: 33%;">0E300-09 L=63.2 (27.7-35.5)</td> <td>24x3</td> </tr> </table>	CILINDRO SAGOMATO (Nichelato Fin.12)		Frontale	con borchie		senza borchie	0E300-12 L=69 (28.5-39.5)	0E300-09 L=63.2 (27.7-35.5)	24x3	
Contropiastra Regolabile in Metallo																							
A	B	C																					
06463-32	06463-32 (16)	06465-42 (pz.2)																					
(17) = inserto rullo art. 06141-71																							
CILINDRO SAGOMATO (Nichelato Fin.12)		Frontale																					
con borchie		senza borchie																					
0E300-12 L=69 (28.5-39.5)	0E300-09 L=63.2 (27.7-35.5)	24x3																					

serratura di sicurezza per montante multipunto

<table border="1" style="width: 100%; border-collapse: collapse;"> <tr> <th colspan="4">Contropiastra Regolabile in Metallo</th> </tr> <tr> <th>A</th> <th>B</th> <th>C</th> <th>Deviatori</th> </tr> <tr> <td>06463-22</td> <td>06463-22 (17)</td> <td>06465-22</td> <td>06465-22 (pz.2)</td> </tr> <tr> <td colspan="4">(17) = inserto rullo art. 06141-71</td> </tr> </table>	Contropiastra Regolabile in Metallo				A	B	C	Deviatori	06463-22	06463-22 (17)	06465-22	06465-22 (pz.2)	(17) = inserto rullo art. 06141-71				<table border="1" style="width: 100%; border-collapse: collapse;"> <tr> <th colspan="2">CILINDRO SAGOMATO (Nichelato Fin.12)</th> <th>Frontale</th> </tr> <tr> <td>con borchie</td> <td>senza borchie</td> <td></td> </tr> <tr> <td>0E300-12 L=69 (29,5-39,5)</td> <td>0E300-41 L=63,2 (27,7-35,5)</td> <td>24x3</td> </tr> </table> <p>E= 35 mm</p>	CILINDRO SAGOMATO (Nichelato Fin.12)		Frontale	con borchie	senza borchie		0E300-12 L=69 (29,5-39,5)	0E300-41 L=63,2 (27,7-35,5)	24x3	
Contropiastra Regolabile in Metallo																											
A	B	C	Deviatori																								
06463-22	06463-22 (17)	06465-22	06465-22 (pz.2)																								
(17) = inserto rullo art. 06141-71																											
CILINDRO SAGOMATO (Nichelato Fin.12)		Frontale																									
con borchie	senza borchie																										
0E300-12 L=69 (29,5-39,5)	0E300-41 L=63,2 (27,7-35,5)	24x3																									
<p>A</p>	<p>B</p>	<p>C</p>																									
<p>Art. 16525 Art. 46525</p>	<p>Art. 46550</p>	<p>Art. 46520</p>																									

<table border="1" style="width: 100%; border-collapse: collapse;"> <tr> <th colspan="4">Contropiastra Regolabile in Metallo</th> </tr> <tr> <th>A</th> <th>B</th> <th>C</th> <th>Deviatori</th> </tr> <tr> <td>06463-22</td> <td>06463-22 (17)</td> <td>06465-22</td> <td>06465-22 (pz.2)</td> </tr> <tr> <td colspan="4">(17) = inserto rullo art. 06141-71</td> </tr> </table>	Contropiastra Regolabile in Metallo				A	B	C	Deviatori	06463-22	06463-22 (17)	06465-22	06465-22 (pz.2)	(17) = inserto rullo art. 06141-71				<table border="1" style="width: 100%; border-collapse: collapse;"> <tr> <th colspan="2">CILINDRO SAGOMATO (Nichelato Fin.12)</th> <th>Frontale</th> </tr> <tr> <td>con borchie</td> <td>senza borchie</td> <td></td> </tr> <tr> <td>0E300-12 L=69 (29,5-39,5)</td> <td>0E300-09 L=63,2 (27,7-35,5)</td> <td>24x3</td> </tr> </table> <p>E= 35 mm</p>	CILINDRO SAGOMATO (Nichelato Fin.12)		Frontale	con borchie	senza borchie		0E300-12 L=69 (29,5-39,5)	0E300-09 L=63,2 (27,7-35,5)	24x3	
Contropiastra Regolabile in Metallo																											
A	B	C	Deviatori																								
06463-22	06463-22 (17)	06465-22	06465-22 (pz.2)																								
(17) = inserto rullo art. 06141-71																											
CILINDRO SAGOMATO (Nichelato Fin.12)		Frontale																									
con borchie	senza borchie																										
0E300-12 L=69 (29,5-39,5)	0E300-09 L=63,2 (27,7-35,5)	24x3																									
<p>A</p>	<p>B</p>	<p>C</p>																									
<p>Art. 16525 Art. 46525</p>	<p>Art. 46550</p>	<p>Art. 46520</p>																									

serratura di sicurezza per montante multipunto

Contropiastra Regolabile in Metallo			Deviatori
A	B	C	
06463-22	06463-22 (17)	06465-22	06465-22 (pz.2)
(17) = inserto rullo art. 06141-71			

CILINDRO SAGOMATO (Nichelato Fin.12)		Frontale
con borchie	0E300-12 L=60 (29,5-39,5)	24x3
senza borchie	0E300-41 L=60,2 (27,7-35,5)	24x3

E = 35 mm

PL 2037 PL 2013 PL 2037

A

Art. 16525
Art. 46525

B

Art. 46550

C

Art. 46520

Contropiastra Regolabile in Metallo			Deviatori
A	B	C	
06463-22	06463-22 (17)	06465-22	06465-22 (pz.2)
(17) = inserto rullo art. 06141-71			

CILINDRO SAGOMATO (Nichelato Fin.12)		Frontale
con borchie	0E300-09 L=60,2 (27,7-35,5)	24x3
senza borchie	0E300-12 L=60 (29,5-39,5)	24x3

E = 35 mm

PL 2036 PL 2013 PL 2036

A

Art. 16525
Art. 46525

B

Art. 46550

C

Art. 46520

serratura di sicurezza per fascia

<p>Contropiastra Regolabile in Metallo</p> <table border="1"> <tr> <th>A</th> <th>B</th> <th>C</th> <th>D-E</th> <th>Frontale</th> </tr> <tr> <td>06465-22</td> <td>06465-22 (16)</td> <td>06465-22 (pz. 3)</td> <td>06465-22 (pz. 2)</td> <td>22x3</td> </tr> </table> <p>(17) = inserto rullo art. 06141-71</p>	A	B	C	D-E	Frontale	06465-22	06465-22 (16)	06465-22 (pz. 3)	06465-22 (pz. 2)	22x3	<p>CILINDRO SAGOMATO (Nichelato Fin.12)</p> <table border="1"> <tr> <th>con borchie</th> <th>senza borchie</th> </tr> <tr> <td>0E300-08 L=59,2 (27,7-31,5)</td> <td>0E300-05 L=56,4 (27,7-27,7)</td> </tr> </table>	con borchie	senza borchie	0E300-08 L=59,2 (27,7-31,5)	0E300-05 L=56,4 (27,7-27,7)	<p>PL 2037</p> <p>PL 2032</p> <p>18</p> <p>E= 100 mm</p>
A	B	C	D-E	Frontale												
06465-22	06465-22 (16)	06465-22 (pz. 3)	06465-22 (pz. 2)	22x3												
con borchie	senza borchie															
0E300-08 L=59,2 (27,7-31,5)	0E300-05 L=56,4 (27,7-27,7)															
<p>A</p> <p>art. 56357</p>	<p>B</p>	<p>C</p> <p>art. 56357 art. 06168-00 Kit Multipunto Modulare 24x3</p>	<p>D</p> <p>art. 06444-45</p>	<p>E</p> <p>art. 06444-21-0</p> <p>art. 06443-00/05-0</p>												
<p>Contropiastra Regolabile in Metallo</p> <table border="1"> <tr> <th>A</th> <th>B</th> <th>C</th> <th>D-E</th> <th>Frontale</th> </tr> <tr> <td>06465-22</td> <td>06465-22 (16)</td> <td>06465-22 (pz. 3)</td> <td>06465-22 (pz. 2)</td> <td>22x3</td> </tr> </table> <p>(17) = inserto rullo art. 06141-71</p>	A	B	C	D-E	Frontale	06465-22	06465-22 (16)	06465-22 (pz. 3)	06465-22 (pz. 2)	22x3	<p>CILINDRO SAGOMATO (Nichelato Fin.12)</p> <table border="1"> <tr> <th>con borchie</th> <th>senza borchie</th> </tr> <tr> <td>0E300-12 L=69 (29,5-39,5)</td> <td>0E300-09 L=63,2 (27,7-35,5)</td> </tr> </table>	con borchie	senza borchie	0E300-12 L=69 (29,5-39,5)	0E300-09 L=63,2 (27,7-35,5)	<p>PL 2037</p> <p>PL 2013</p> <p>PL 2037</p> <p>18</p> <p>E= 100 mm</p>
A	B	C	D-E	Frontale												
06465-22	06465-22 (16)	06465-22 (pz. 3)	06465-22 (pz. 2)	22x3												
con borchie	senza borchie															
0E300-12 L=69 (29,5-39,5)	0E300-09 L=63,2 (27,7-35,5)															
<p>A</p> <p>art. 56357</p>	<p>B</p>	<p>C</p> <p>art. 56357 art. 06168-00 Kit Multipunto Modulare 24x3</p>	<p>D</p> <p>art. 06444-45</p>	<p>E</p> <p>art. 06444-21-0</p> <p>art. 06443-00/05-0</p>												

maniglioni antipanico con serratura di sicurezza

Contropiastra Regolabile in Metallo		Accessori	
A	Deviatori	1/2 Maniglia	Aste
06463-32	06465-22 (pz.2)	07070-66-0-B1 Funz. B/D	Blocca Aste
Utilizzare salvaprofilo art. -		Bocchetta Pavimento art. -	

CILINDRO SAGOMATO (Nichelato Fin.12)		Frontale
con borchie		
0E300-12 L=69 (29.5-39.5)	senza borchie	24x3
0E300-09 L=63.2 (27.7-35.5)		

E= 40 mm

	Art. 43725 Funz. A/D Art. 43735 Funz. B	 Maniglione quadro 9mm art. 59710-00 art. 59710-01	 Quadro Maniglia art. 07085-77-0	 Maniglione quadro 8mm art. 59605-06	 Barra Ovale art. 07007-XX	 Maniglione quadro 8mm art. 59615-17	 Barra Ovale art. 07007-XX
--	--	---	--	--	----------------------------------	--	----------------------------------

Contropiastra Regolabile in Metallo		Accessori	
A	Deviatori	1/2 Maniglia	Aste
43295-60	06465-22 (pz.2)	07070-66-0-B1 Funz. B/D	Blocca Aste 07089-52 (Facoltativo)
Utilizzare salvaprofilo art. -		Bocchetta Pavimento art. 06141-80	

CILINDRO SAGOMATO (Nichelato Fin.12)		Frontale
con borchie		
0E300-12 L=69 (29.5-39.5)	senza borchie	24x3
0E300-09 L=63.2 (27.7-35.5)		

E= 40mm

NB. il cilindro è calcolato per il maniglione 59605 e 59710 in caso si voglia utilizzare il maniglione 59615 il cilindro deve sporgere di minimo 11.5mm dal filo del profilo interno

	Art. 43725 Funz. A/D Art. 43735 Funz. B	 Maniglione quadro 9mm art. 59710-00 art. 59710-01	 Quadro Maniglia art. 07085-77-0	 Maniglione quadro 8mm art. 59605-06	 Barra Ovale art. 07007-XX	 Maniglione quadro 8mm art. 59615-17	 Barra Ovale art. 07007-XX
--	--	---	--	--	----------------------------------	--	----------------------------------

NB. il cilindro è calcolato per il maniglione 59605 e 59710 in caso si voglia utilizzare il maniglione 59615 il cilindro deve sporgere di minimo 11.5mm dal filo del profilo interno

maniglione antipanico con serratura di sicurezza

riarmo manuale per chiusure superiore ed inferiore-sezione verticale

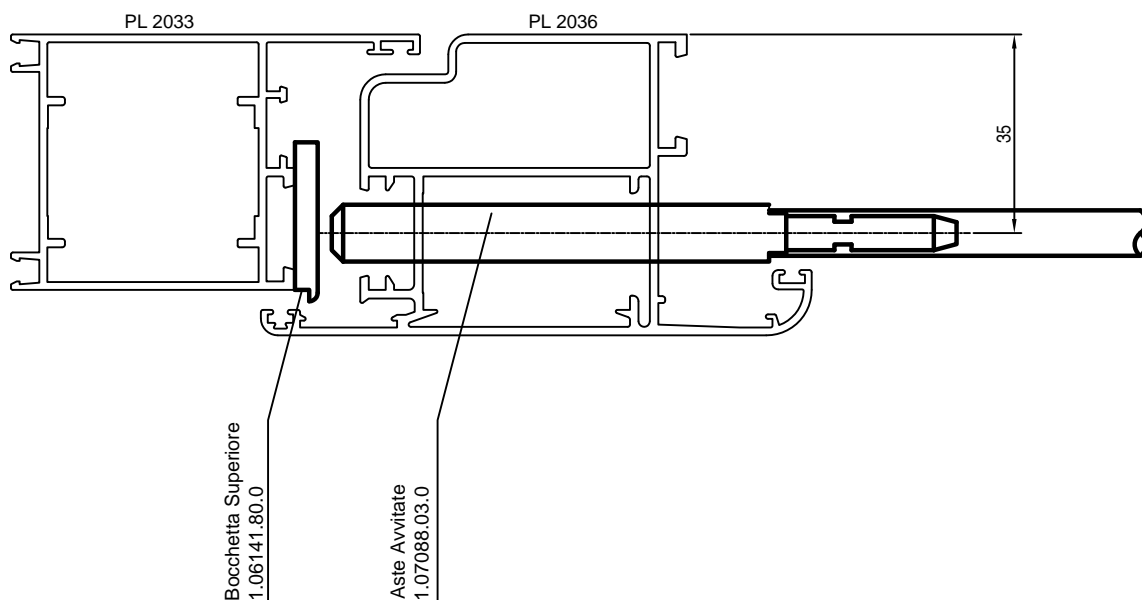

riarmo automatico per chiusure superiore ed inferiore
sezione verticale

